

Miniature solid-state relay - OPT-24DC/ 24DC/ 2 - 2966595

Please be informed that the data shown in this PDF Document is generated from our Online Catalog. Please find the complete data in the user's documentation. Our General Terms of Use for Downloads are valid (<http://download.phoenixcontact.com>)



Plug-in miniature solid-state relay, power solid-state relay, input: 24 V DC, output: 3 - 33 V DC/3 A

The illustration shows the version OPT-24DC/48DC/100

Product Features

- Vibration and shock resistant
- RT III wash tight (comparable with IP67)
- Wear-free and durable
- Switching power of up to 24 V DC/5 A
- Zero voltage switch at AC output
- Can be soldered on PCB

Key commercial data

package_quantity	10
GTIN	4017918130947

Technical data

Dimensions

Width	5 mm
Height	28 mm
Depth	15 mm

Ambient conditions

Ambient temperature (operation)	-25 °C ... 60 °C
Ambient temperature (storage/transport)	-25 °C ... 70 °C

Input data

Nominal input voltage U_N	24 V DC
Input voltage range in reference to U_N	0.8 ... 1.2
Switching threshold "0" signal, voltage	≤ 10 V
Switching threshold "1" signal voltage	≥ 16 V
Typical input current at U_N	7 mA
Typical response time	20 μ s (at U_N)
Typical turn-off time	300 μ s (at U_N)
Transmission frequency	300 Hz

Miniature solid-state relay - OPT-24DC/ 24DC/ 2 - 2966595

Technical data

Output data

Output voltage range	3 V DC ... 33 V DC
Limiting continuous current	3 A (see derating curve)
Maximum inrush current	15 A (10 ms)
Voltage drop at max. limiting continuous current	≤ 150 mV
Output circuit	2-wire, floating
Type of protection	Protection against polarity reversal
Type of protection	Surge protection

General

Test voltage input/output	2.5 kV (50 Hz, 1 min.)
Mounting position	Any
Assembly instructions	In rows with zero spacing
Operating mode	100% operating factor
Name	Standards/regulations
Standards/regulations	IEC 60664
Standards/regulations	EN 50178
Standards/regulations	IEC 62103
Rated surge voltage / insulation	Basic insulation
Pollution degree	2
Surge voltage category	III

classifications

eCl@ss

eCl@ss 4.0	27371102
eCl@ss 4.1	27371102
eCl@ss 5.0	27371001
eCl@ss 5.1	27371001
eCl@ss 6.0	27371604
eCl@ss 7.0	27371604
eCl@ss 8.0	27371604

ETIM

ETIM 2.0	EC001504
ETIM 3.0	EC001504
ETIM 4.0	EC001504
ETIM 5.0	EC001504

UNSPSC

UNSPSC 6.01	30211916
UNSPSC 7.0901	39121542
UNSPSC 11	39121542
UNSPSC 12.01	39121542

Miniature solid-state relay - OPT-24DC/ 24DC/ 2 - 2966595

classifications

UNSPSC

UNSPSC 13.2	39121542
-------------	----------

approvals

UL Recognized / cUL Recognized / GOST / GL / UL Recognized / cUL Recognized / cULus Recognized /

Approval details

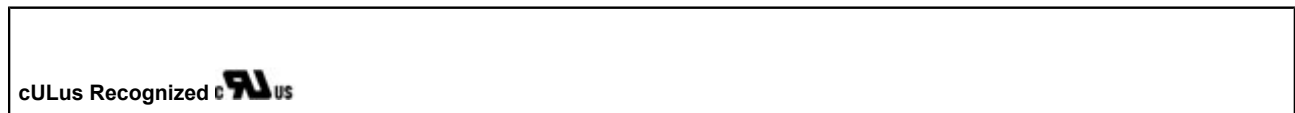
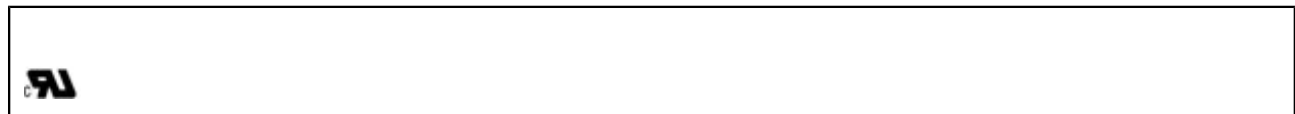
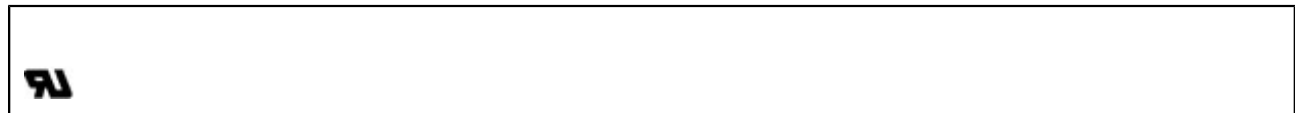
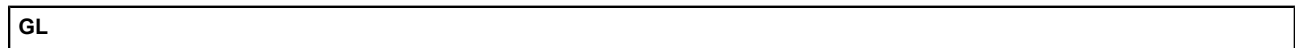
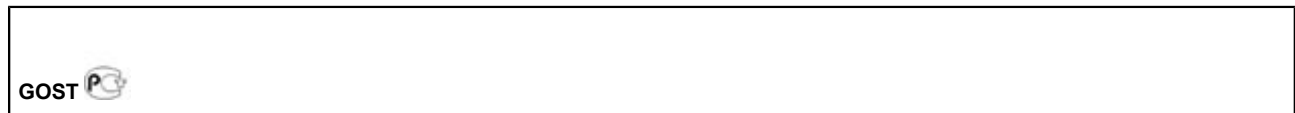
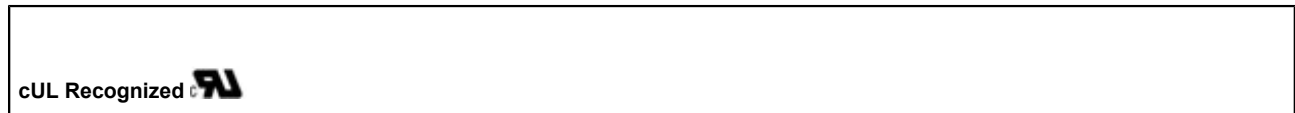

Drawings

Miniature solid-state relay - OPT-24DC/ 24DC/ 2 - 2966595

Drilling diagram

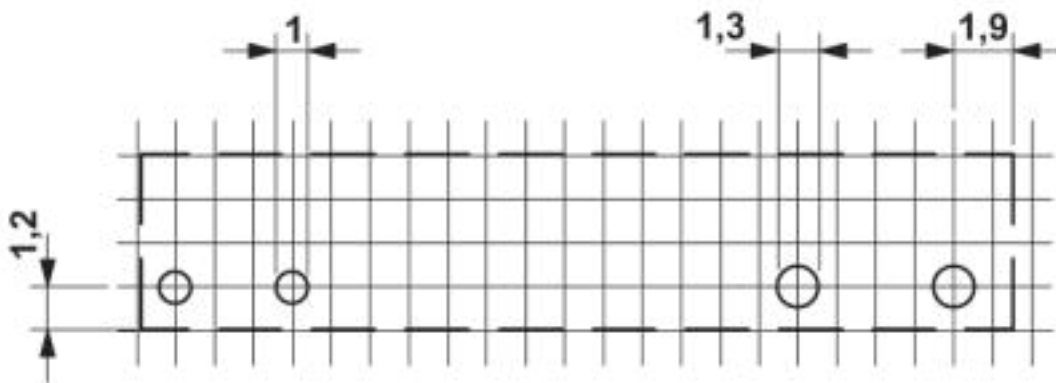

a = pitch division 1.25 mm and 1.27 mm

Diagram

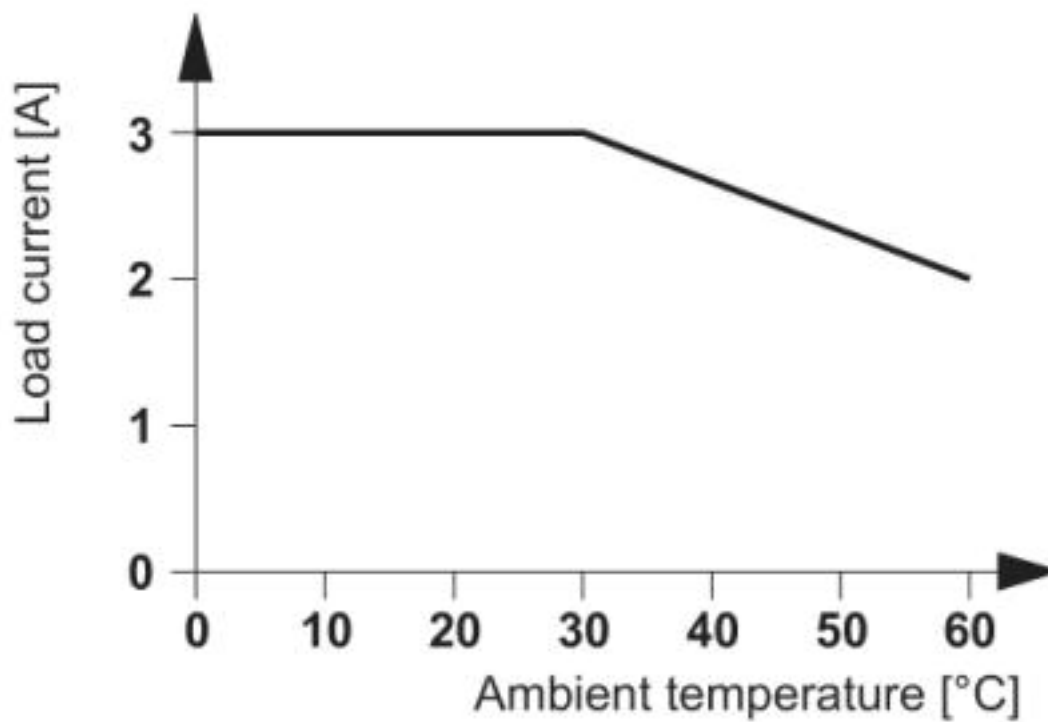

Miniature solid-state relay - OPT-24DC/ 24DC/ 2 - 2966595

Dimensioned drawing

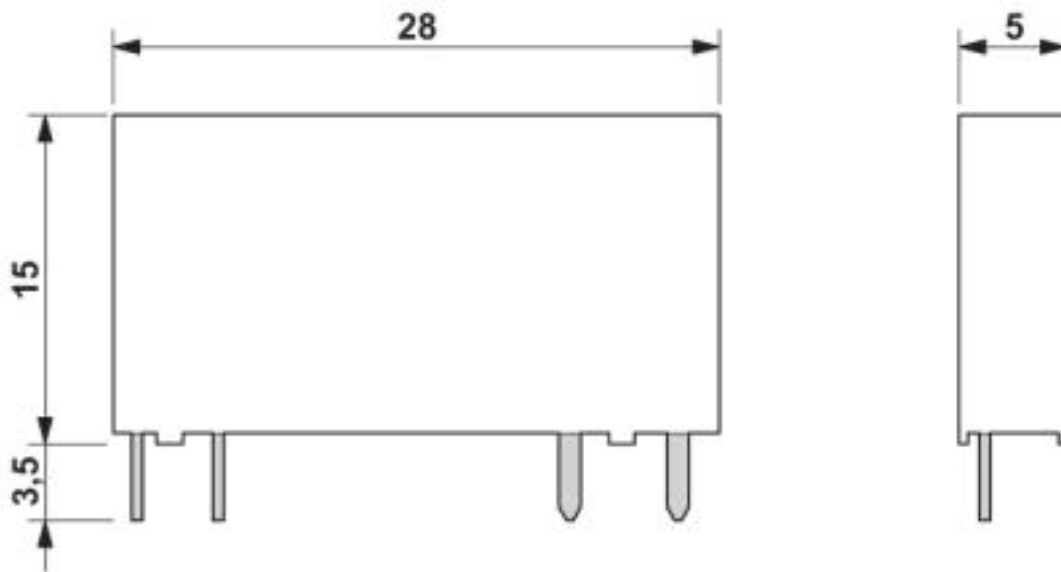

Circuit diagram

