

# Power supply unit - QUINT-PS/ 1AC/12DC/15 - 2866718

Please be informed that the data shown in this PDF Document is generated from our Online Catalog. Please find the complete data in the user's documentation. Our General Terms of Use for Downloads are valid (<http://download.phoenixcontact.com>)



Primary-switched QUINT power supply for DIN rail mounting, input: 1-phase, output: 12 V DC/15 A, with integrated SFB (selective fuse breaking) technology, including mounted universal DIN rail adapter UTA 107

## Product Description

QUINT POWER power supply units – Maximum system availability with SFB technology  
 Compact power supply units of the new QUINT POWER generation maximize the availability of your system. With the SFB technology (Selective Fuse Breaking Technology), six times the nominal current for 12 ms, even the standard power circuit-breakers can now also be triggered reliably and quickly. Faulty current paths are switched off selectively, the fault is located and important system parts continue to operate. Comprehensive diagnostics are provided through constant monitoring of output voltage and current. This preventive function monitoring visualizes critical operating modes and reports them to the control unit before an error can occur.

## Product Features

- Quick tripping of standard circuit breakers
- Reliable starting of difficult loads
- Preventive function monitoring



## Key commercial data

package_quantity	1
GTIN	4046356307888

## Technical data

### Dimensions

Width	60 mm
Height	130 mm
Depth	125 mm
Width with alternative assembly	122 mm
Height with alternative assembly	130 mm
Depth with alternative assembly	63 mm

### Ambient conditions

Degree of protection	IP20
Ambient temperature (operation)	-25 °C ... 70 °C (> 60°C derating, startup at -40°C type-tested)
Ambient temperature (storage/transport)	-40 °C ... 85 °C
Max. permissible relative humidity (operation)	≤ 95 % (at 25 °C, no condensation)
Noise immunity	EN 61000-6-2:2005

# Power supply unit - QUINT-PS/ 1AC/12DC/15 - 2866718

## Technical data

### Input data

Nominal input voltage range	100 V AC ... 240 V AC
Input voltage range AC	85 V AC ... 264 V AC
Input voltage range DC	90 V DC ... 350 V DC (UL 508: ≤ 250 V DC)
Short-term input voltage	300 V AC
AC frequency range	45 Hz ... 65 Hz
Frequency range DC	0 Hz
Current consumption	1.9 A (120 V AC)
Current consumption	0.9 A (230 V AC)
Inrush surge current	< 15 A (typical)
Power failure bypass	> 65 ms (120 V AC)
Power failure bypass	> 65 ms (230 V AC)
Input fuse	6.3 A (slow-blow, internal)
Choice of suitable fuses	10 A ... 16 A (Characteristics B, C, D, K)
Type of protection	Transient surge protection
Protective circuit/component	Varistor

### Output data

Nominal output voltage	12 V DC ±1%
Setting range of the output voltage	5 V DC ... 18 V DC (> 12 V constant capacity)
Output current	15 A (-25 °C ... 60 °C)
Output current	16 A (with POWER BOOST, -25°C ... 40°C permanent)
Output current	60 A (SFB technology, 12 ms)
Output current	60 A ( $U_{in} \geq 100$ V AC)
Magnetic fuse tripping	B2
Magnetic fuse tripping	B4
Magnetic fuse tripping	B6
Magnetic fuse tripping	C2
Magnetic fuse tripping	C4
Derating	60 °C ... 70 °C (2.5%/K)
Connection in parallel	Yes, for redundancy and increased capacity
Connection in series	Yes
Control deviation	< 1 % (change in load, static 10% ... 90%)
Control deviation	< 2 % (change in load, dynamic 10% ... 90%)
Control deviation	< 0.1 % (change in input voltage ±10%)
Residual ripple	< 10 mV <sub>PP</sub> (with nominal values)
Maximum power dissipation NO-Load	5 W
Power loss nominal load max.	21 W

### General

Net weight	1.1 kg
Efficiency	> 89 % (for 230 V AC and nominal values)
Insulation voltage input/output	4 kV AC (type test)

# Power supply unit - QUINT-PS/ 1AC/12DC/15 - 2866718

## Technical data

### General

<b>Insulation voltage input/output</b>	2 kV AC (routine test)
<b>Protection class</b>	I
<b>MTBF (IEC 61709, SN 29500)</b>	> 570000 h
<b>Mounting position</b>	horizontal DIN rail NS 35, EN 60715
<b>Assembly instructions</b>	Alignable: 5 mm horizontally, 15 mm next to active components, 50 mm vertically
<b>Electromagnetic compatibility</b>	Conformance with EMC Directive 2004/108/EC
<b>Noise emission</b>	EN 50081-2
<b>Low Voltage Directive</b>	Conformance with LV directive 2006/95/EC
<b>Standard – Electrical equipment of machines</b>	EN 60204
<b>Standard - Electrical safety</b>	IEC 60950-1/VDE 0805 (SELV)
<b>Standard – Electronic equipment for use in electrical power installations and their assembly into electrical power installations</b>	EN 50178/VDE 0160 (PELV)
<b>Standard – Safety extra-low voltage</b>	IEC 60950-1 (SELV) and EN 60204 (PELV)
<b>Standard - Safe isolation</b>	DIN VDE 0100-410
<b>Standard - Safe isolation</b>	DIN VDE 0106-1010
<b>Standard – Protection against electric shock</b>	DIN 57100-410
<b>Standard – Protection against shock currents, basic requirements for protective separation in electrical equipment</b>	DIN VDE 0106-101
<b>Standard – Limitation of mains harmonic currents</b>	EN 61000-3-2
<b>Standard - Equipment safety</b>	GS (tested safety)
<b>Standard - Approval for medical use</b>	IEC 60601
<b>Information technology equipment - safety (CB scheme)</b>	CB Scheme
<b>UL approvals</b>	UL Listed UL 508
<b>UL approvals</b>	UL/C-UL Recognized UL 60950
<b>UL approvals</b>	UL ANSI/ISA-12.12.01 Class I, Division 2, Groups A, B, C, D (Hazardous Location)
<b>Surge voltage category</b>	III

### Connection data, input

<b>Connection method</b>	Pluggable screw connection
<b>Conductor cross section solid min.</b>	0.2 mm <sup>2</sup>
<b>Conductor cross section solid max.</b>	2.5 mm <sup>2</sup>
<b>Conductor cross section stranded min.</b>	0.2 mm <sup>2</sup>
<b>Conductor cross section stranded max.</b>	2.5 mm <sup>2</sup>
<b>Conductor cross section AWG/kcmil min.</b>	16
<b>Conductor cross section AWG/kcmil max</b>	12
<b>Stripping length</b>	7 mm
<b>Screw thread</b>	M3

### Connection data, output

<b>Connection method</b>	Pluggable screw connection
<b>Conductor cross section solid min.</b>	0.2 mm <sup>2</sup>

# Power supply unit - QUINT-PS/ 1AC/12DC/15 - 2866718

## Technical data

### Connection data, output

Conductor cross section solid max.	2.5 mm <sup>2</sup>
Conductor cross section stranded min.	0.2 mm <sup>2</sup>
Conductor cross section stranded max.	2.5 mm <sup>2</sup>
Conductor cross section AWG/kcmil min.	16
Conductor cross section AWG/kcmil max	12
Stripping length	7 mm

### Signaling

Output name	DC OK active
Output description	$U_{OUT} > 0.9 \times U_N$ : High signal
Maximum inrush current	20 mA (short-circuit resistant)
Continuous load current	$\leq 20$ mA
Status display	$U_{OUT} > 0.9 \times U_N$ : "DC OK" LED green
Note on status display	$U_{OUT} < 0.9 \times U_N$ : Flashing "DC OK" LED
Note on status display	$I_{OUT} < I_N$ : LED ON
Conductor cross section solid min.	0.2 mm <sup>2</sup>
Conductor cross section solid max.	2.5 mm <sup>2</sup>
Conductor cross section stranded min.	0.2 mm <sup>2</sup>
Conductor cross section stranded max.	2.5 mm <sup>2</sup>
Conductor cross section AWG/kcmil min.	16
Conductor cross section AWG/kcmil max	12
Tightening torque, min	0.5 Nm
Tightening torque max	0.6 Nm
Screw thread	M3
Output name	DC OK floating
Output description	Relay contact, $U_{OUT} > 0.9 \times U_N$ : Contact closed
Maximum switching voltage	30 V AC
Maximum switching voltage	24 V DC
Maximum inrush current	0.5 A
Maximum inrush current	1 A
Continuous load current	1 A
Status display	$U_{OUT} > 0.9 \times U_N$ : "DC OK" LED green
Note on status display	$U_{OUT} < 0.9 \times U_N$ : Flashing "DC OK" LED
Output name	POWER BOOST, active
Output description	$I_{OUT} < I_N$ : High signal
Output voltage	+ 12 V DC
Maximum inrush current	20 mA (short-circuit resistant)
Continuous load current	$\leq 20$ mA
Status display	$I_{OUT} > I_N$ : LED "BOOST" yellow

# Power supply unit - QUINT-PS/ 1AC/12DC/15 - 2866718

## classifications

### eCl@ss

eCl@ss 4.0	27040702
eCl@ss 4.1	27040702
eCl@ss 5.0	27049002
eCl@ss 5.1	27049002
eCl@ss 6.0	27049002
eCl@ss 7.0	27049002
eCl@ss 8.0	27049002

### ETIM

ETIM 2.0	EC001039
ETIM 3.0	EC001039
ETIM 4.0	EC000599
ETIM 5.0	EC002540

### UNSPSC

UNSPSC 6.01	30211502
UNSPSC 7.0901	39121004
UNSPSC 11	39121004
UNSPSC 12.01	39121004
UNSPSC 13.2	39121004

## approvals

UL Listed / cUL Listed / cULus Listed / CSA / UL Recognized / UL Listed / cUL Recognized / GOST / IEC CB Scheme / SEMI F47 / Bauartgeprüft / cULus Recognized /

### Approval details

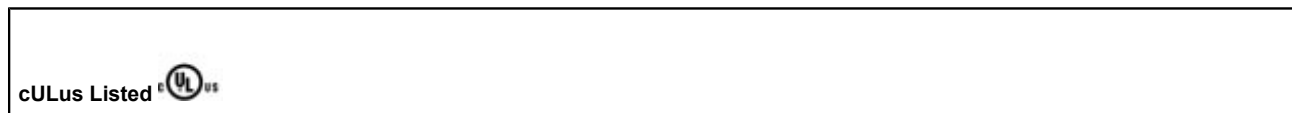
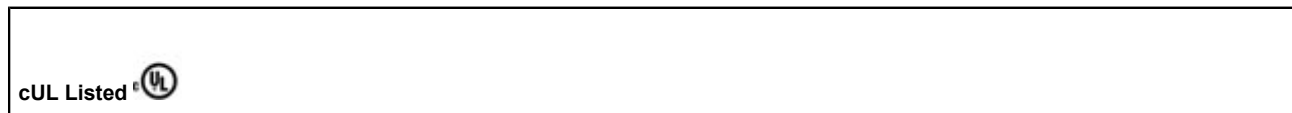
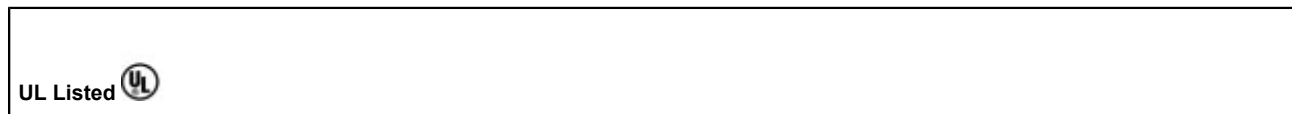

# Power supply unit - QUINT-PS/ 1AC/12DC/15 - 2866718

approvals

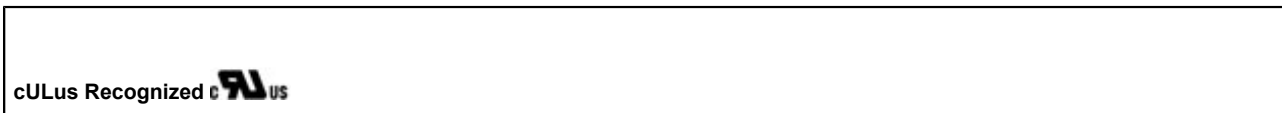
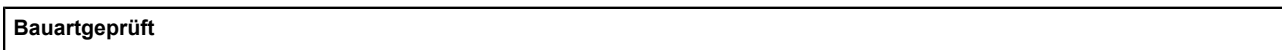
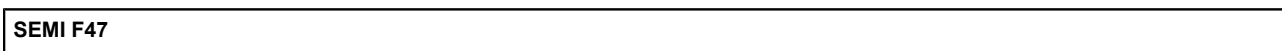
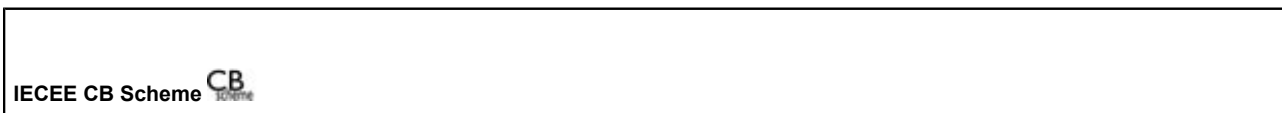
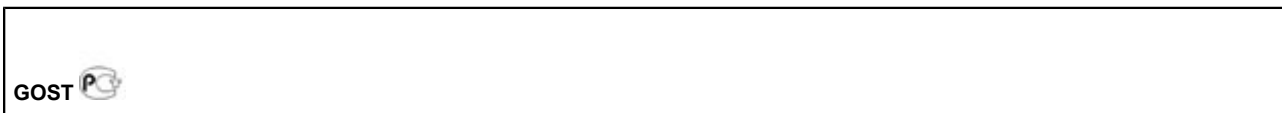
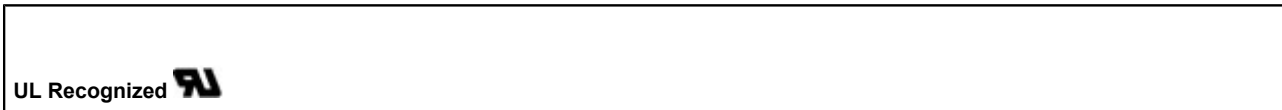

accessories

## Mounting rail adapter

UTA 107 - 2853983



---

## Assembly adapter

## Power supply unit - QUINT-PS/ 1AC/12DC/15 - 2866718

accessories

UWA 182/52 - 2938235

---

QUINT-PS-ADAPTERS7/2 - 2938206



---

### Redundancy module

QUINT-DIODE/12-24DC/2X20/1X40 - 2320157



---

TRIO-DIODE/12-24DC/2X10/1X20 - 2866514



---

### Thermomagnetic device circuit breakers

CB TM1 1A SFB P - 2800836



## Power supply unit - QUINT-PS/ 1AC/12DC/15 - 2866718

### accessories

CB TM1 2A SFB P - 2800837



CB TM1 3A SFB P - 2800838



CB TM1 4A SFB P - 2800839



CB TM1 5A SFB P - 2800840



### Drawings



# Power supply unit - QUINT-PS/ 1AC/12DC/15 - 2866718

Block diagram

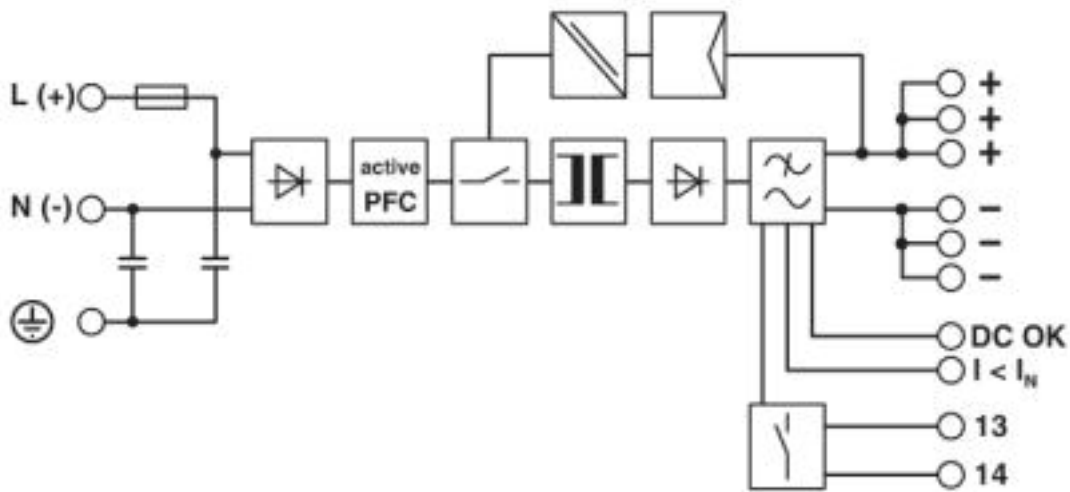

© Phoenix Contact 2013 - all rights reserved  
<http://www.phoenixcontact.com>