

# Current transformer - PACT MCR-V1-21-44-150-5A-1 - 2277035

Please be informed that the data shown in this PDF Document is generated from our Online Catalog. Please find the complete data in the user's documentation. Our General Terms of Use for Downloads are valid (<http://download.phoenixcontact.com>)



Bus-bar current transformer, 150 A AC primary current; 5 A AC secondary current; accuracy class 1; 5 VA rated power

## Key commercial data

package_quantity	1
GTIN	4046356305112

## Technical data

### Dimensions

Primary round conductor (diameter)	21 mm
Width	30 mm
Height	66 mm
Depth	44 mm
Width with alternative assembly	44 mm
Height with alternative assembly	66 mm
Depth with alternative assembly	30 mm

### Ambient conditions

Ambient temperature (operation)	-25 °C ... 40 °C
Ambient temperature (storage/transport)	-25 °C ... 40 °C

### Input data

Thermal rated short-time current	$I_{th} = 60 * I_n$
Rated surge current	$I_{dyn} = 2.5 * I_{th}$
Rated frequency: Standard converter	50 Hz ... 60 Hz
Surge current limitation factor	FS 5
Rated power	5 VA
Primary rated current $I_{pn}$	0 A ... 150 A
Secondary rated current $I_{sn}$	5 A AC

### General

Converter type	Tube rod converter
Class	1
Can be calibrated	No
Rated insulation voltage	1 kV

# Current transformer - PACT MCR-V1-21-44-150-5A-1 - 2277035

## Technical data

### General

<b>Test voltage input/output</b>	3 kV (50 Hz, 1 min.)
<b>Standards/regulations</b>	IEC 60044-1
<b>Color</b>	black
<b>Housing material</b>	Polyamide PA fiberglass reinforced

## classifications

### eCl@ss

<b>eCl@ss 4.0</b>	27210902
<b>eCl@ss 4.1</b>	27210902
<b>eCl@ss 5.0</b>	27210902
<b>eCl@ss 5.1</b>	27210902
<b>eCl@ss 6.0</b>	27210902
<b>eCl@ss 7.0</b>	27210902
<b>eCl@ss 8.0</b>	27210902

### ETIM

<b>ETIM 2.0</b>	EC001505
<b>ETIM 3.0</b>	EC001505
<b>ETIM 4.0</b>	EC002048
<b>ETIM 5.0</b>	EC002048

### UNSPSC

<b>UNSPSC 6.01</b>	30211501
<b>UNSPSC 7.0901</b>	39121019
<b>UNSPSC 11</b>	39121006
<b>UNSPSC 12.01</b>	39121006
<b>UNSPSC 13.2</b>	39121006

## Drawings

# Current transformer - PACT MCR-V1-21-44-150-5A-1 - 2277035

Dimensioned drawing

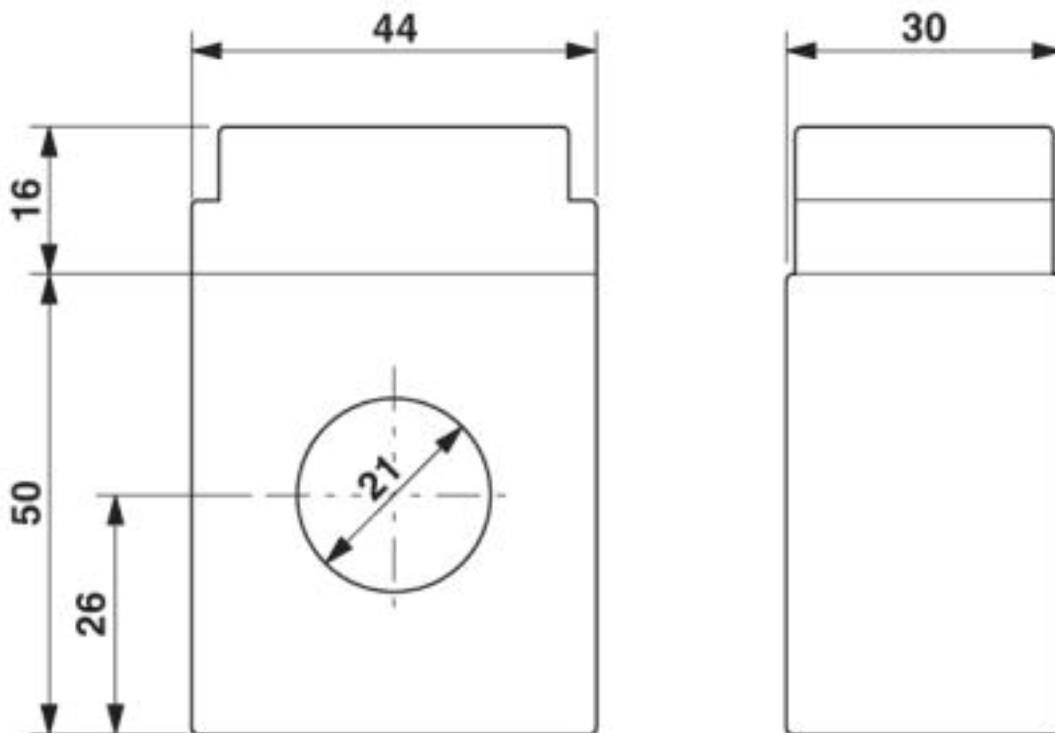

© Phoenix Contact 2013 - all rights reserved  
<http://www.phoenixcontact.com>