

Current transformer - PACT MCR-V1-21-44-250-5A-1 - 2277048

Please be informed that the data shown in this PDF Document is generated from our Online Catalog. Please find the complete data in the user's documentation. Our General Terms of Use for Downloads are valid (<http://download.phoenixcontact.com>)



Bus-bar current transformer, 250 A AC primary current; 5 A AC secondary current; accuracy class 1; 5 VA rated power

Key commercial data

package_quantity	1
GTIN	4046356305105

Technical data

Dimensions

Primary round conductor (diameter)	21 mm
Width	30 mm
Height	66 mm
Depth	44 mm
Width with alternative assembly	44 mm
Height with alternative assembly	66 mm
Depth with alternative assembly	30 mm

Ambient conditions

Ambient temperature (operation)	-25 °C ... 40 °C
Ambient temperature (storage/transport)	-25 °C ... 40 °C

Input data

Thermal rated short-time current	$I_{th} = 60 * I_n$
Rated surge current	$I_{dyn} = 2.5 * I_{th}$
Rated frequency: Standard converter	50 Hz ... 60 Hz
Surge current limitation factor	FS 5
Rated power	5 VA
Primary rated current I_{pn}	0 A ... 250 A
Secondary rated current I_{sn}	5 A AC

General

Converter type	Tube rod converter
Class	1
Can be calibrated	No
Rated insulation voltage	1 kV

Current transformer - PACT MCR-V1-21-44-250-5A-1 - 2277048

Technical data

General

Test voltage input/output	3 kV (50 Hz, 1 min.)
Standards/regulations	IEC 60044-1
Color	black
Housing material	Polyamide PA fiberglass reinforced

classifications

eCl@ss

eCl@ss 4.0	27210902
eCl@ss 4.1	27210902
eCl@ss 5.0	27210902
eCl@ss 5.1	27210902
eCl@ss 6.0	27210902
eCl@ss 7.0	27210902
eCl@ss 8.0	27210902

ETIM

ETIM 2.0	EC001505
ETIM 3.0	EC001505
ETIM 4.0	EC002048
ETIM 5.0	EC002048

UNSPSC

UNSPSC 6.01	30211501
UNSPSC 7.0901	39121019
UNSPSC 11	39121006
UNSPSC 12.01	39121006
UNSPSC 13.2	39121006

Drawings

Current transformer - PACT MCR-V1-21-44-250-5A-1 - 2277048

Dimensioned drawing

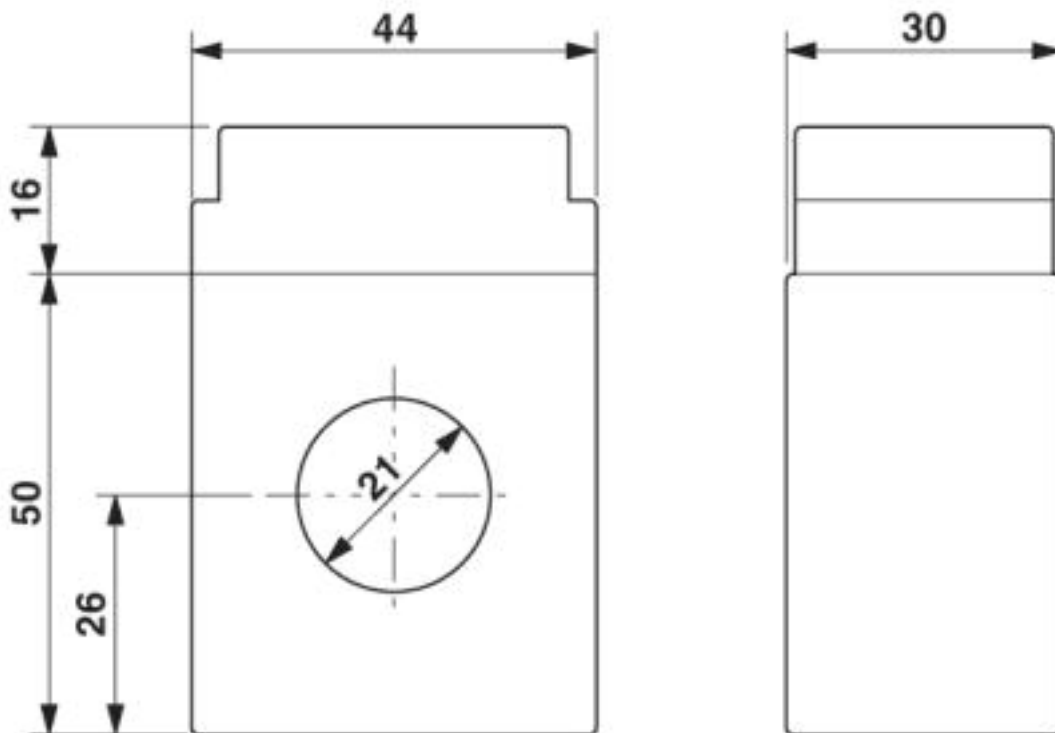

© Phoenix Contact 2013 - all rights reserved
<http://www.phoenixcontact.com>