

Elma TT

Logistik GmbH

Constructional data for isolating transformers and safety transformers:

1.3 Reference of type : PV/0-7098
1.4 Trade mark : CONRAD
1.5 Other markings : IZ 812 - Conrad Art. Nr. 514263
1.6 Europe standard : EN 61558 - 2 - 6

2.1 Protection against electric shock : Non short.circuit proof
2.2 Class of protection to IEC 529 : IP 00
2.3 Type of construction (Isolating transformer, Transformer for toys) : Safety-isolating transformer
2.4 Stationary Transformer : Stationary, to built-in transformer
Portable Transformer :
2.5 Protection against short-circuit according to Sub-clause
inherently short-circuit proof :
non-inherently short-circuit proof :
non short-circuit proof : Non short-circuit proof
fail safe
(rated current of the cutout)
2.6 Rated maximum ambient temperature : t_a 40 °C
2.7 Class : B Insulation : IEC 60 085 and IEC 60 216

3. Electrical values		prim :	sec:
3.1 Rated voltage(s)	V :	230	12
3.2 Rated frequency	Hz :	50	
3.3 Rated current	A :	0,511	8,33
3.4 Rated output	VA :		100

4. Windings

4.1 Coil base,	number :	1	
	material :	Duretan AKV 30 H – PA 6.6	
4.2 Material of layer insulation :		Film poliestere 0.13 , classe B-130 - Teflex	
4.3 Windings,	number :	736	41
	material :	Enoflex G1 – S180	G2 Mediotherm 200
4.4 Diameter of wire (mm) :		0,45	1,8

4.5 Windings insulation, material : polyurethane polyamide polyurethane polyamide

5. Iron core

5.1 Sheet metall, material : EI 84 V 530 – 50

main dimensions : 84x70x40

5.2 Cross-sectional drawing : See specification of insulation materials

6. Type of construction

6.1 Open – Covered – In case protection : Open

6.2 Impregnated – Undrowned – Drowned : Impregnated

6.3 Soaking (liquor) :

6.4 Underpressure – Overpressure – Soaking at : Soaking

6.5 Drown material : 1K – Traenkarz E8561 Blaugrau Herberts

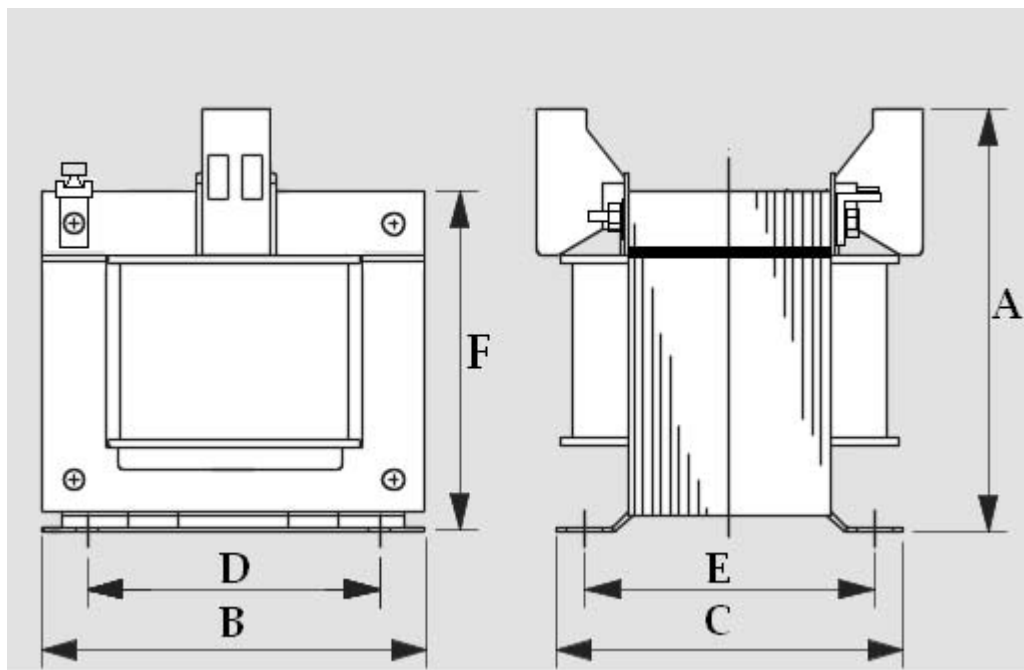

A(mm)	B(mm)	C(mm)	D(mm)	E(mm)	F(mm)	Weight (kg)
91	84	76	64	63,5	74,5	2,0

ELMA TT

11.01.2010