

# Multi-Range DC Power Supply

PSW Series

---

## USER MANUAL

GW INSTEK PART NO. 825W-80400M01



ISO-9001 CERTIFIED MANUFACTURER

**GW INSTEK**

This manual contains proprietary information, which is protected by copyright. All rights are reserved. No part of this manual may be photocopied, reproduced or translated to another language without prior written consent of Good Will company.

The information in this manual was correct at the time of printing. However, Good Will continues to improve products and reserves the rights to change specification, equipment, and maintenance procedures at any time without notice.

**Good Will Instrument Co., Ltd.**  
**No. 7-1, Jhongsing Rd., Tucheng Dist., New Taipei City 236, Taiwan.**

# Table of Contents

<b>SAFETY INSTRUCTIONS</b> .....	<b>5</b>
<b>GETTING STARTED</b> .....	<b>9</b>
PSW Series Overview .....	10
Appearance .....	14
Theory of Operation .....	20
<b>OPERATION</b> .....	<b>31</b>
Set Up .....	33
Basic Operation .....	43
Parallel / Series Operation .....	54
Test Scripts .....	66
<b>CONFIGURATION</b> .....	<b>74</b>
Configuration .....	75
<b>ANALOG CONTROL</b> .....	<b>88</b>
Analog Remote Control Overview .....	89
Remote Monitoring .....	104
<b>COMMUNICATION INTERFACE</b> .....	<b>107</b>
Interface Configuration .....	108
<b>MAINTENANCE</b> .....	<b>112</b>
<b>FAQ</b> .....	<b>114</b>
<b>APPENDIX</b> .....	<b>116</b>
PSW Default Settings .....	116
Error Messages & Messages .....	118
LCD Display Format .....	118

PSW Specifications ..... 119  
PSW Dimensions ..... 128  
Declaration of Conformity..... 131

**I**NDEX.....**132**

# S SAFETY INSTRUCTIONS

This chapter contains important safety instructions that you must follow during operation and storage. Read the following before any operation to insure your safety and to keep the instrument in the best possible condition.

## Safety Symbols

These safety symbols may appear in this manual or on the instrument.

---



WARNING

Warning: Identifies conditions or practices that could result in injury or loss of life.



CAUTION

Caution: Identifies conditions or practices that could result in damage to the PSW or to other properties.



DANGER High Voltage



Attention Refer to the Manual



Protective Conductor Terminal



Earth (ground) Terminal



Do not dispose electronic equipment as unsorted municipal waste. Please use a separate collection facility or contact the supplier from which this instrument was purchased.

## Safety Guidelines

---

### General Guideline



#### CAUTION

- Do not place any heavy object on the PSW.
- Avoid severe impact or rough handling that leads to damaging the PSW.
- Do not discharge static electricity to the PSW.
- Use only mating connectors, not bare wires, for the terminals.
- Do not block the cooling fan opening.
- Do not disassemble the PSW unless you are qualified.

(Measurement categories) EN 61010-1:2001 specifies the measurement categories and their requirements as follows. the PSW falls under category II.

- Measurement category IV is for measurement performed at the source of low-voltage installation.
- Measurement category III is for measurement performed in the building installation.
- Measurement category II is for measurement performed on the circuits directly connected to the low voltage installation.
- Measurement category I is for measurements performed on circuits not directly connected to Mains.

---

### Power Supply



#### WARNING

- AC Input voltage range: 85VAC~265VAC
  - Frequency: 47Hz~63Hz
  - To avoid electrical shock connect the protective grounding conductor of the AC power cord to an earth ground.
-

- 
- Cleaning the PSW
- Disconnect the power cord before cleaning.
  - Use a soft cloth dampened in a solution of mild detergent and water. Do not spray any liquid.
  - Do not use chemicals containing harsh material such as benzene, toluene, xylene, and acetone.
- 

Operation  
Environment

- Location: Indoor, no direct sunlight, dust free, almost non-conductive pollution (Note below)
- Relative Humidity: 20%~ 85%
- Altitude: < 2000m
- Temperature: 0°C to 50°C

(Pollution Degree) EN 61010-1:2001 specifies the pollution degrees and their requirements as follows. The PSW falls under degree 2.

Pollution refers to “addition of foreign matter, solid, liquid, or gaseous (ionized gases), that may produce a reduction of dielectric strength or surface resistivity”.

- Pollution degree 1: No pollution or only dry, non-conductive pollution occurs. The pollution has no influence.
  - Pollution degree 2: Normally only non-conductive pollution occurs. Occasionally, however, a temporary conductivity caused by condensation must be expected.
  - Pollution degree 3: Conductive pollution occurs, or dry, non-conductive pollution occurs which becomes conductive due to condensation which is expected. In such conditions, equipment is normally protected against exposure to direct sunlight, precipitation, and full wind pressure, but neither temperature nor humidity is controlled.
- 

Storage  
environment

- Location: Indoor
  - Temperature: -25°C to 70°C
  - Relative Humidity: <90%
- 

Disposal



Do not dispose this instrument as unsorted municipal waste. Please use a separate collection facility or contact the supplier from which this instrument was purchased. Please make sure discarded electrical waste is properly recycled to reduce environmental impact.

## Power cord for the United Kingdom

When using the power supply in the United Kingdom, make sure the power cord meets the following safety instructions.

NOTE: This lead/appliance must only be wired by competent persons

 **WARNING: THIS APPLIANCE MUST BE EARTHED**

IMPORTANT: The wires in this lead are coloured in accordance with the following code:

Green/ Yellow:	Earth
Blue:	Neutral
Brown:	Live (Phase)



As the colours of the wires in main leads may not correspond with the coloured marking identified in your plug/appliance, proceed as follows:

The wire which is coloured Green & Yellow must be connected to the Earth terminal marked with either the letter E, the earth symbol  or coloured Green/Green & Yellow.

The wire which is coloured Blue must be connected to the terminal which is marked with the letter N or coloured Blue or Black.

The wire which is coloured Brown must be connected to the terminal marked with the letter L or P or coloured Brown or Red.

If in doubt, consult the instructions provided with the equipment or contact the supplier.

This cable/appliance should be protected by a suitably rated and approved HBC mains fuse: refer to the rating information on the equipment and/or user instructions for details. As a guide, a cable of 0.75mm<sup>2</sup> should be protected by a 3A or 5A fuse. Larger conductors would normally require 13A types, depending on the connection method used.

Any exposed wiring from a cable, plug or connection that is engaged in a live socket is extremely hazardous. If a cable or plug is deemed hazardous, turn off the mains power and remove the cable, any fuses and fuse assemblies. All hazardous wiring must be immediately destroyed and replaced in accordance to the above standard.



# G E T T I N G   S T A R T E D

This chapter describes the power supply in a nutshell, including its main features and front / rear panel introduction. After going through the overview, please read the theory of operation to become familiar with the operating modes, protection modes and other safety considerations.



---

<b>PSW Series Overview</b> .....	<b>10</b>
Series lineup.....	10
Main Features.....	11
Accessories.....	11
Package Contents.....	13
<b>Appearance</b> .....	<b>14</b>
PSW Front Panel .....	14
Rear Panel.....	17

## PSW Series Overview

### Series lineup

The PSW series consists of 6 models, divided into 3 different model types covering 3 power capacities: Type I (360 Watt), Type II (720 Watt) and Type III (1080 Watt).

Model name	Type	Voltage Rating	Current Rating	Power
PSW 30-36	Type I	0~30V	0~36A	360W
PSW 80-13.5	Type I	0~80V	0~13.5A	360W
PSW 30-72	Type II	0~30V	0~72A	720W
PSW 80-27	Type II	0~80V	0~27A	720W
PSW 30-108	Type III	0~30V	0~108A	1080W
PSW 80-40.5	Type III	0~80V	0~40.5A	1080W

Apart from the differences in output, each unit differs in size. The 720 and 1080 watt models are larger than the 360 watt models to accommodate the increase in power.

360 Watt models

720 Watt models

1080 Watt models

Type I

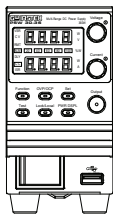

Type II

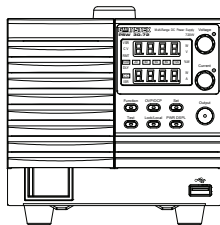

Type III

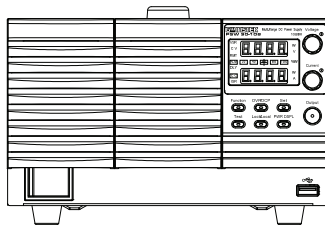

## Main Features

---

- Performance
- High performance/power
  - Power efficient switching type power supply
  - Low impact on load devices
  - Fast transient recovery time of 1ms
  - Fast output response time
- 

- Features
- OVP, OCP and OTP protection
  - Adjustable voltage and current slew rates
  - User adjustable bleeder control to quickly dissipate the power after shutdown to safe levels.
  - Extensive remote monitoring and control options
  - Support for serial and parallel connections
  - Power on configuration settings.
  - Supports test scripts
  - Web server monitoring and control
- 

- Interface
- Ethernet port
  - Analog connector for analog voltage and current monitoring
  - USB host and device port

## Accessories

---

Standard Accessories	Part number	Description
	Region dependant	User manual
	4323-30600101	Power cord (Type I/II)

4320-91001101	Power cord (Type III)
63SC-XF100201	Output terminal cover: top
63SC-XF100301	Output terminal cover: bottom
GTL-123	Test leads: 1x red, 1x black
PSW-004	Basic Accessory Kit: M4 terminal screws and washers x2, M8 terminal bolts, nuts and washers x2, Air filter x1, Analog control protection dummy x1, Analog control lock level x1

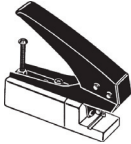
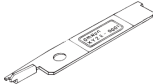
Optional Accessories	Part number	Description
	GET-001	Extended terminal
	PSW-001	Accessory Kit: Pin contact x10, Socket x1, Protection cover x1
	PSW-002	Simple IDC Tool 
	PSW-003	Contact Removal Tool 
	GRA-410-J	Rack mount adapter (JIS)
	GRA-410-E	Rack mount adapter (EIA)
	GUG-001	GPIB to USB adapter
	GTL-246	USB Cable
	57RG-30B00201	Large filter (Type II/III)

Download	Name	Description
	psw_cdc.inf	USB driver

## Package Contents

Check the contents before using the PSW.

---

### Opening the box

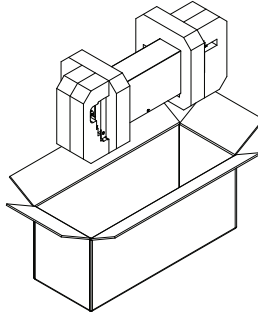

#### Contents (single unit)

- Main unit
- Output terminal cover (top x1, bottom x1)
- Test leads (red x1, black x1)
- M4 terminal screws and washers x2
- Air filter x1
- Power cord x1 (region dependent)
- Analog control protection dummy x1
- Analog control lock lever x1
- M8 terminal bolts, nuts and washers X2

# Appearance

## PSW Front Panel

PSW 80-27, PSW 30-72 (720W)

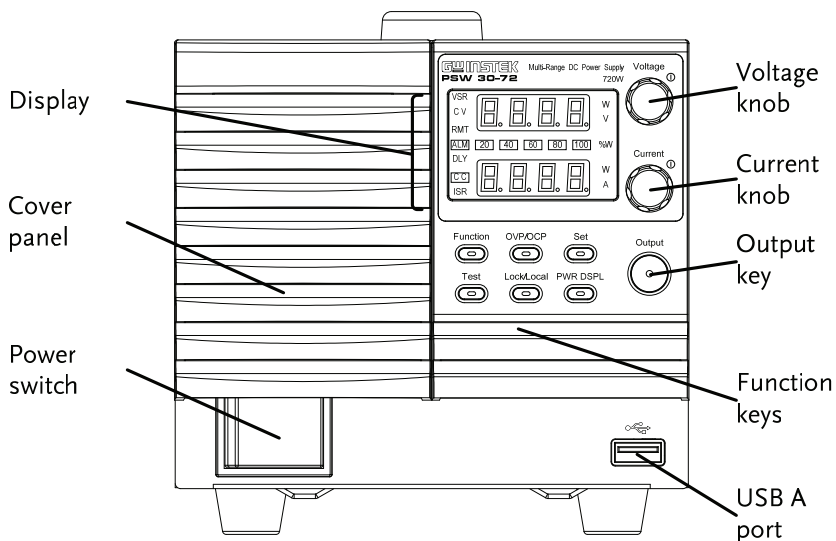

PSW 80-40.5, PSW 30-108 (1080W)

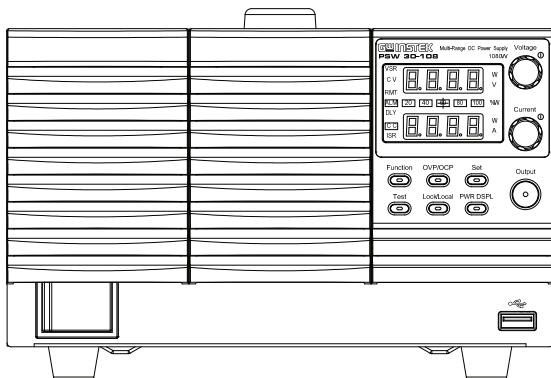

PSW 80-13.5,  
PSW 30-36 (360W)

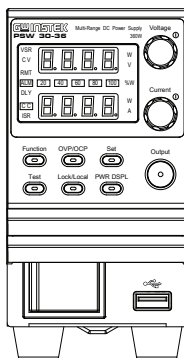

**Function Keys**      The Function keys along with the Output key will light up when a key is active.

- Function



The Function key is used to configure the power supply.
- OVP/OCPL



Set the over current or over voltage protection levels.
- Set



Sets the current and voltage limits.
- Test



Used to run customized scripts for testing.
- Lock/Local



Locks or unlocks the panel keys to prevent accidentally changing panel settings.
- PWR DSPL



Toggles the display from viewing V/A → V/W → A/W.

- Display Indicators**
- VSR**      Voltage Slew Rate
  - C V**      Constant Voltage Mode
  - RMT**      Remote Control Mode
  - ALM**      Alarm on
  - DLY**      Delay Output
  - CC**      Constant Current Mode
  - ISR**      Current Slew Rate



Power bar  
Indicates the current power output as a percentage.

Voltage Knob

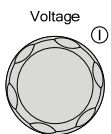

Sets the voltage.

Current Knob

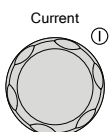

Sets the current.

Output

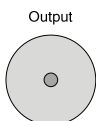

Press to turn on the output. The Output key will light up when the output is active.

USB

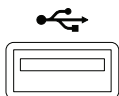

USB A port for data transfer, loading test scripts etc.

Power Switch

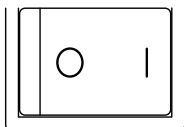

Used to turn the power on/off.



**Rear Panel**

PSW 80-27, PSW 30-72 (720W)

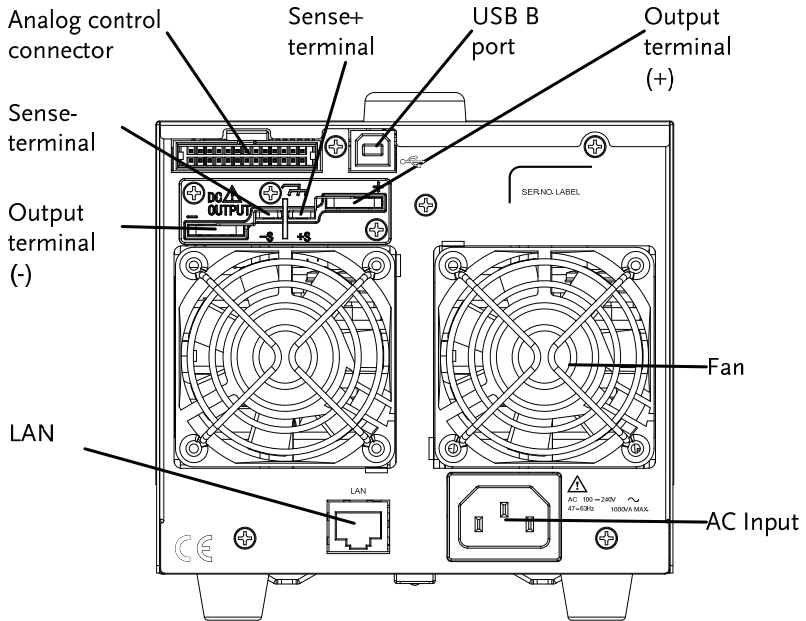

PSW 80-40.5, PSW 30-108 (1080W)

PSW 80-13.5,  
PSW 30-36 (360W)

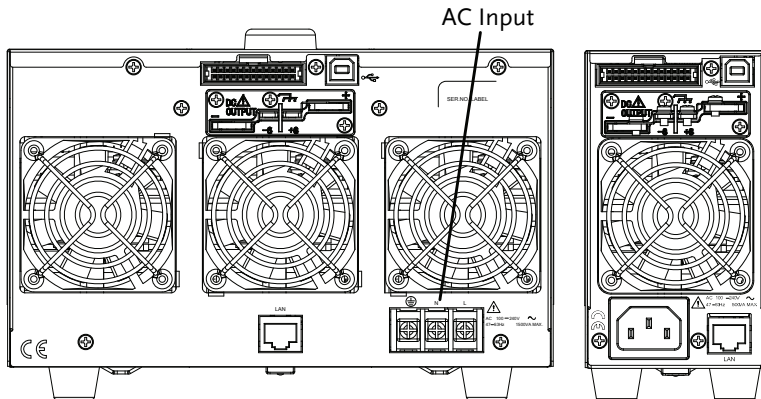

Analog Control Connector



Standard 26 pin MIL connector (OMRON XG4 IDC plug).

The analog control connector is used to monitor current and voltage output, machine status (OVP, OCP, OTP etc.), and for analog control of the current and voltage output.

Use an OMRON XG5 IDC socket as the mating socket.

Output Terminals

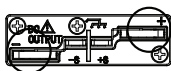

Positive (+) and negative (-) output terminals.



Chassis ground



Sense (-) and Sense (+) terminals.

USB B port

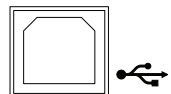

The USB B port is used for remote control.

Fans

Temperature controlled fans

Ethernet Port

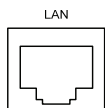

The ethernet port is used for remote control and digital monitoring from a PC.

Line Voltage Input  
(Type I/TypeII)

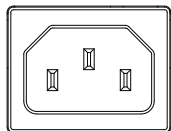

Type I: PSW 30-36/80-13.5

Type II: PSW 30-72/80-27

- Voltage Input: 100~240 VAC
- Line frequency: 50Hz/60 Hz (Automatically switchable)

Line Voltage  
Input  
(Type III)

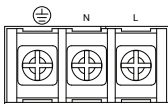

Type III: PSW 30-108/80-40.5

- Voltage Input: 100~240 VAC
- Line frequency: 50Hz/60 Hz  
(Automatically switchable)

## Theory of Operation

The theory of operation chapter describes the basic principles of operation, protection modes and important considerations that must be taken into account before use.

### Operating Area Description

---

#### Description

The PSW power supplies are regulated DC power supplies with a high voltage and current output. These operate in CC or CV mode within a wide operating range limited only by the output power.

The operating area of each power supply is determined by the rated output power as well as the voltage and current rating. For example the operating area and rated power output for the PSW 30-36 is shown below.

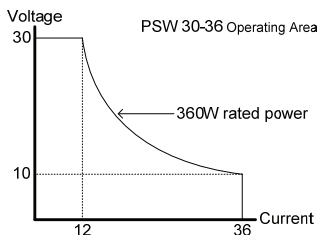

When the power supply is configured so that the total output (current x voltage output) is less than the rated power output, the power supply functions as a typical constant current, constant voltage power supply.

If however, the power supply is configured such that the total output (current x voltage output) exceeds the rated power output, the

effective output is actually limited to the power limit of the unit. In this case the output current and voltage then depend purely on the load value.

Below is a comparison of the operating areas of each power supply.

**PSW 80V Series Operating Area**

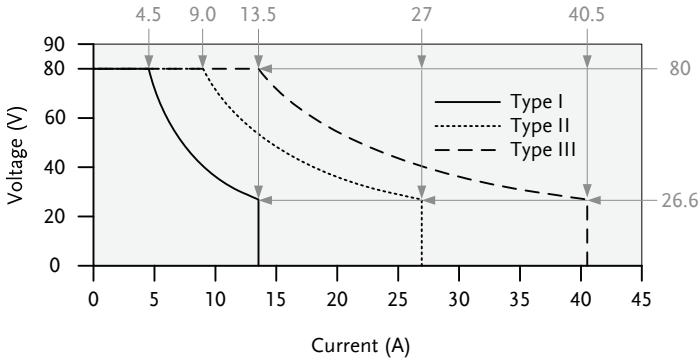

**PSW 30V Series Operating Area**

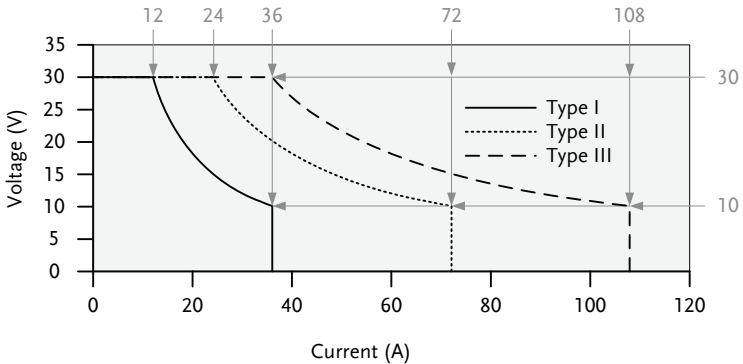

## CC and CV Mode

---

### CC and CV mode Description

When the power supply is operating in constant current mode (CC) a constant current will be supplied to the load. When in constant current mode the voltage output can vary, whilst the current remains constant. When the load resistance increases to the point where the current limit ( $I_{SET}$ ) can no longer be sustained the power supply switches to CV mode. The point where the power supply switches modes is the crossover point.

When the power supply is operating in CV mode, a constant voltage will be supplied to the load, whilst the current will vary as the load varies. At the point that the load resistance is too low to maintain a constant voltage, the power supply will switch to CC mode and maintain the set current limit.

The conditions that determine whether the power supply operates in CC or CV mode depends on the set current ( $I_{SET}$ ), the set voltage ( $V_{SET}$ ), the load resistance ( $R_L$ ) and the critical resistance ( $R_C$ ). The critical resistance is determined by  $V_{SET}/I_{SET}$ . The power supply will operate in CV mode when the load resistance is greater than the critical resistance. This means that the voltage output will be equal to the  $V_{SET}$  voltage but the current will be less than  $I_{SET}$ . If the load resistance is reduced to the point that the current output reaches the  $I_{SET}$  level, the power supply switches to CC mode.

Conversely the power supply will operate in CC mode when the load resistance is less than the critical resistance. In CC mode the current output is equal to  $I_{SET}$  and the voltage output is less than  $V_{SET}$ .

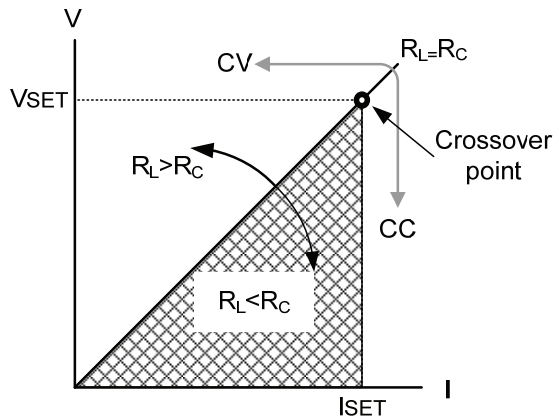

## Slew Rate

---

### Theory

The PSW has selectable slew rates for CC and CV mode. This gives the PSW power supply the ability to limit the current/voltage draw of the power supply. Slew rate settings are divided into High Speed Priority and Slew Rate Priority. High Speed Priority mode disables slew rate settings for CC or CV mode. Slew Rate Priority mode allows for user adjustable slew rates for CC or CV mode. The rising and falling slew rate can be set independently.

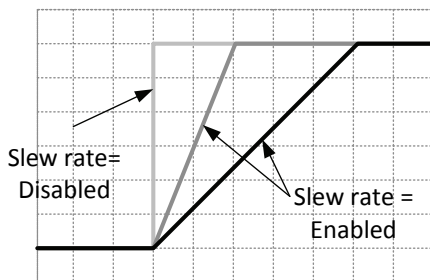

## Bleeder Control

---

### Description

The PSW DC power supplies employ a bleed resistor in parallel with the output terminals.

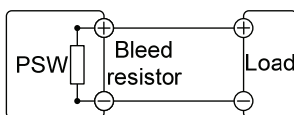

Bleed resistors are designed to dissipate the power from the power supply filter capacitors when power is turned off and the load is disconnected. Without a bleed resistor, power



may remain charged on the filter capacitors for some time and be potentially hazardous.

In addition, bleed resistors also allow for smoother voltage regulation of the power supply as the bleed resistor acts as a minimum voltage load.

The bleed resistance can be turned on or off using the configuration settings.



Note

By default the bleed resistance is on. For battery charging applications, be sure to turn the bleed resistance off as the bleed resistor can discharge the connected battery when the unit is off.

## Internal Resistance

### Description

On the PSW, the internal resistance of the power supply can be user-defined in software. (Internal Resistance Setting, page 78). When the internal resistance is set it can be seen as a resistance in series with the positive output terminal. This allows the power supply to simulate power sources that have internal resistances such as lead acid batteries.

### Internal Resistance Range

Unit Model	Internal Resistance Range
PSW 30-36	0.000 ~ 0.833Ω
PSW 30-72	0.000 ~ 0.417Ω
PSW 30-108	0.000 ~ 0.278Ω
PSW 80-13.5	0.000 ~ 5.926Ω
PSW 80-27	0.000 ~ 2.963Ω
PSW 80-40.5	0.000 ~ 1.975Ω

## Alarms

The PSW power supplies have a number of protection features. When one of the protection alarms are set, the ALM icon on the display will be lit. For details on how to set the protection modes, please see page 43.

---

OVP	Overvoltage protection (OVP) prevents a high voltage from damaging the load.
OCP	Overcurrent protection prevents high current from damaging the load.
OTP	Over temperature protection protects the instrument from overheating.
Power Switch Trip	When the Power Switch Trip configuration setting is enabled, the power supply will automatically shut down when a protection setting has been tripped (OCP, OVP, OTP).
Alarm output	Alarms are output via the analog control connector. The alarm output is an isolated open-collector photo coupler output.

## Considerations

The following situations should be taken into consideration when using the power supply.

---

Inrush current	When the power supply switch is first turned on, an inrush current is generated. Ensure there is enough power available for the power supply when first turned on, especially if a number of units are turned on at the same time.
----------------	--

---

**Pulsed or Peaked loads**

When the load has current peaks or is pulsed, it is possible for the maximum current to exceed the mean current value. The PSW power supply ammeter only indicates mean current values, which means for pulsed current loads, the actual current can exceed the indicated value. For pulsed loads, the current limit must be increased, or a power supply with a greater capacity must be chosen. As shown below, a pulsed load may exceed the current limit and the indicated current on the power supply ammeter.

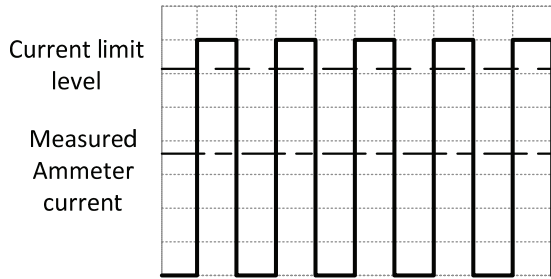

**Reverse Current: Regenerative load**

When the power supply is connected to a regenerative load such as a transformer or inverter, reverse current will feed back to the power supply. The PSW power supply cannot absorb reverse current. For loads that create reverse current, connect a resistor in parallel to the power supply to bypass the reverse current. This description only applies when the bleed resistance is off.

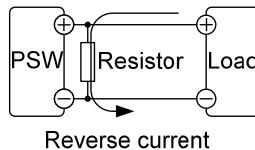



Note

The current output will decrease by the amount of current absorbed by the resistor.

Ensure the resistor used can withstand the power capacity of the power supply/load.

Reverse Current:  
Accumulative  
energy.

When the power supply is connected to a load such as a battery, reverse current may flow back to the power supply. To prevent damage to the power supply, use a reverse-current-protection diode in series between the power supply and load.

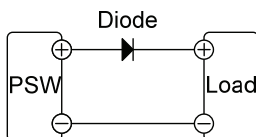

CAUTION

Ensure the reverse withstand voltage of the diode is able to withstand 2 times the rated output voltage of the power supply and the forward current capacity can withstand 3 to 10 times the rated output current of the power supply.

Ensure the diode is able to withstand the heat generated in the following scenarios.

When the diode is used to limit reverse voltage, remote sensing cannot be used.

### Grounding

The output terminals of the PSW power supplies are isolated with respect to the protective grounding terminal. The insulation capacity of the load, the load cables and other connected devices must be taken into consideration when connected to the protective ground or when floating.

### Floating

As the output terminals are floating, the load and all load cables must have an insulation capacity that is greater than the isolation voltage of the power supply.

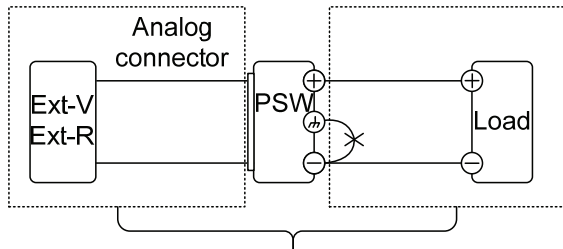

(-----) Insulation capacity  $\geq$  isolation voltage of power supply



### WARNING

If the insulation capacity of the load and load cables is not greater than the isolation voltage of the power supply, electric shock may occur.

Grounded output terminal

If the positive or negative terminal is connected to the protective ground terminal, the insulation capacity needed for the load and load cables is greatly reduced. The insulation capacity only needs to be greater than the maximum output voltage of the power supply with respect to ground.

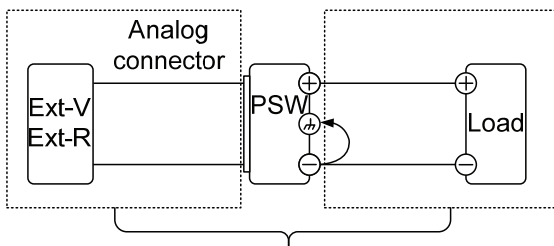

(-----) Insulation capacity  $\geq$  voltage of power supply with respect to ground



**CAUTION**

If using external voltage control, do not ground the external voltage terminal as this will create a short circuit.

# PERATION

---

<b>Set Up</b> .....	<b>33</b>
Line Voltage Connection – Type III Models.....	33
Filter Installation.....	35
Power Up.....	36
Wire Gauge Considerations.....	37
Output Terminals .....	38
Using the Output Terminal Cover .....	40
Using the Rack Mount Kit.....	41
How to Use the Instrument .....	41
<b>Basic Operation</b> .....	<b>43</b>
Setting OVP/OCP Levels .....	43
Set to C.V. Mode .....	45
Set to C.C. Mode.....	47
Display Modes.....	49
Panel Lock .....	50
Remote Sense .....	50
<b>Parallel / Series Operation</b> .....	<b>54</b>
Master-Slave Parallel Overview.....	55
Master-Slave Parallel Connection .....	56
Master-Slave Parallel Operation.....	59
Master-Slave Series Overview .....	61
Master-Slave Series Connection.....	62
Master-Slave Series Operation .....	64
<b>Test Scripts</b> .....	<b>66</b>
Test Script File Format .....	67
Test Script Settings .....	67
Setting the Test Function Settings.....	68
Load Test Script from USB.....	69
Run Test Script.....	70
Export Test Script to USB .....	71

Delete Test Script ..... 72



## Set Up

### Line Voltage Connection – Type III Models

---

**Background** The Type III (PSW 30-108/PSW 80-40.5) models use a universal power input that can be used with 100 and 200 VAC systems. To connect or replace the power cord (GW Instek part number: 4320-91001101, use the procedure below:

---



Warning

The following procedure should only be attempted by competent persons.

Ensure the AC power cord is not connected to power.

---

**Removal**

1. Turn off the power switch.

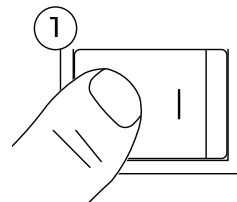

2. Unscrew the power cord protective sheath.
3. Remove the 2 screws holding the power cord cover and remove.

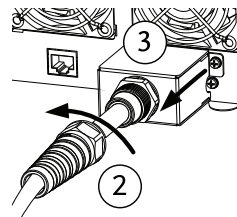

4. Slide the cover off the AC terminals.
5. Remove the AC power cord wires.

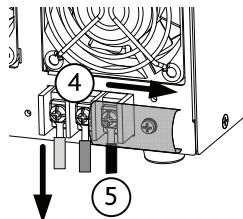

**Installation**

1. Connect the AC power cord wires to the AC input terminals.

- White/Blue → Neutral (N)
- Green/Green-yellow → GND (⊕)
- Black/Brown → Line (L)

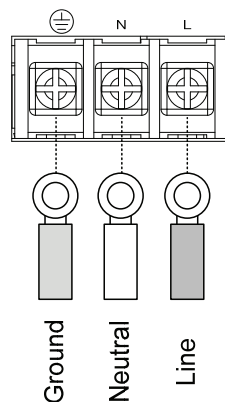

2. Set the cover back over the AC terminals.

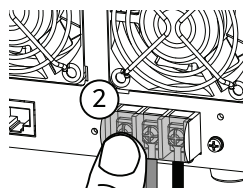

3. Re-install the power cord cover.
4. Screw the power cord sheath back onto the cover.

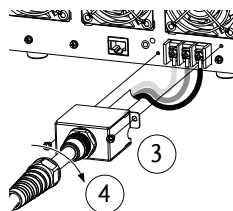

## Filter Installation

---

**Background**                      The PSW has a small filter (GW Instek part number, 57RG-30B00101) that must first be inserted under the control panel before operation. The small filter must be inserted for all model types (Type I/II/II).

---

- Steps**
1. Insert the small filter in the open area under the control panel.



Type II shown as an example

2. The unit is now ready to power up.

## Power Up

**Steps**

1. Type I or II: Connect the power cord to the rear panel socket.

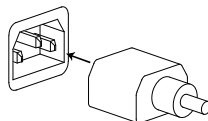

Type III: Connect the power cord to the universal power input.

Page 33

2. Press the POWER key. If used for the first time, the default settings will appear on the display, otherwise The PSW recovers the state right before the power was last turned OFF.

For default configuration settings, see page 116.

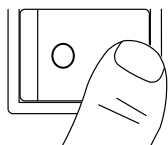

**! CAUTION**

The power supply takes around 8 seconds to fully turn on and shutdown.

Do not turn the power on and off quickly. Please wait for the display to fully turn off.

## Wire Gauge Considerations

---

### Background

Before connecting the output terminals to a load, the wire gauge of the cables should be considered.

It is essential that the current capacity of the load cables is adequate. The rating of the cables must equal or exceed the maximum current rated output of the instrument.

### Recommended wire gauge

Wire Gauge	Maximum Current
20	2.5A
18	4A
16	6A
14	10A
12	16A
10	21A
8	36A
6	61A
4	97A

## Output Terminals

### Background

Before connecting the output terminals to the load, first consider whether voltage sense will be used, the gauge of the cable wiring and the withstand voltage of the cables and load.

The output terminals can be connected to load cables using M4 sized screws or M8 sized bolts.

### WARNING

Dangerous voltages. Ensure that the power to the instrument is disabled before handling the power supply output terminals. Failing to do so may lead to electric shock.

1. Turn the power switch off.

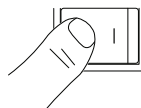

2. Remove the output terminal cover. Page 40
3. If necessary, screw the chassis ground terminal to either the positive or negative terminal. See the grounding chapter for details. Page 29

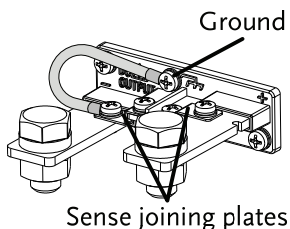

4. Choose a suitable wire gauge for the load cables. Page 37

5. Choose a suitable crimp for the terminals.
6. If using voltage sense, remove the Page 50 sense terminal joining plates and connect sensing wires to the load(s).
7. Connect the positive load cable to the positive output terminal and the negative cable to the negative output terminal.
8. Reattach the output terminal Page 40 cover.

Connection without sense wiring

Using M4 screws

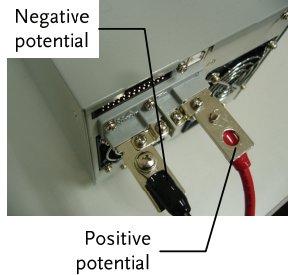

Using M8 bolts

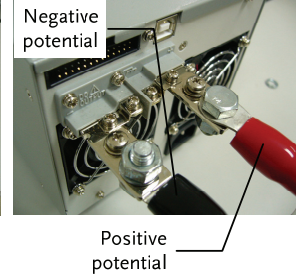

Connection with sense wiring

Using M4 screws

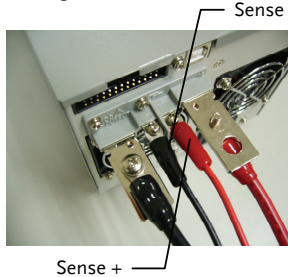

Using M8 bolts

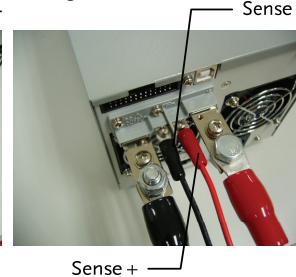

## Using the Output Terminal Cover

### Background

1. Line-up the bottom cover with the notch in the output terminals.
2. Place the top terminal cover over the bottom cover.

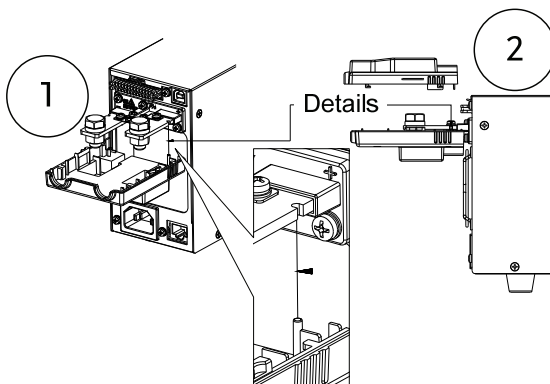

3. Use your thumb to slide the terminal covers shut, as shown in the diagram below.
4. The top and bottom cover should be flush, as shown in the diagram.

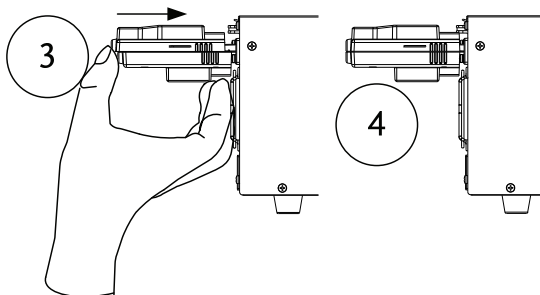



Removal Reverse the procedure to remove the terminal covers.

## Using the Rack Mount Kit

---

Background The PSW series has an optional Rack Mount Kit (GW Instek part number: [JIS] GRA-410-J, [EIA] GRA-410-E[EIA]) that can be used to hold 6x PSW Type I models, 3x Type II models, 2x Type III models or a combination of all models (1x Type I, 1x Type II and 1x Type III).

Rack mount diagram

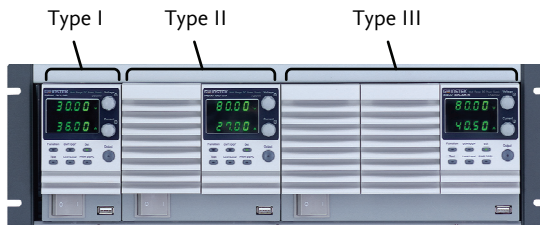

## How to Use the Instrument

---

Background The PSW power supplies use a novel method of configuring parameter values only using the voltage or current knobs. The knobs are used to quickly edit parameter values at 0.01, 0.1 or 1 unit steps at a time.

When the user manual says to set a value or parameter, use the steps below.

---

Example Use the voltage knob to set a voltage of 10.05 volts.

1. Repeatedly press the voltage knob until the last digit is highlighted. This will allow the voltage to be edited in 0.01 volt steps.

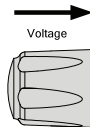

2. Turn the voltage knob till 0.05 volts is shown.

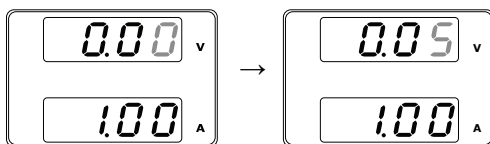
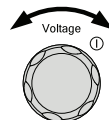

3. Repeatedly press the voltage knob until the first digit is highlighted. This will allow the voltage to be edited in 1 volt steps.
4. Turn the voltage knob until 10.05 is shown.

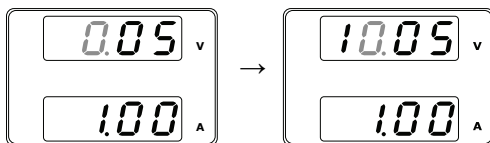

 **Note**

Notice the Set key becomes illuminated when setting the current or voltage.

If the voltage or current knobs are unresponsive, press the Set key first.

## Basic Operation

This section describes the basic operations required to operate the power supply.

- Setting OVP/OCP → from page 43
- C.V. mode → from page 45
- C.C. mode → from page 47
- Display modes → page 49
- Panel lock → page 50
- Remote sensing → from page 50

Before operating the power supply, please see the Getting Started chapter, page 9.

### Setting OVP/OCP Levels

---

The OVP and OCP levels have a selectable range of 10% to 110% of the rated output voltage/current of the power supply. The OVP and OCP level is set to 110% by default. When one of the protection measures are on, ALM is shown on the panel display.



By default, the power switch will turn off when any of the protection levels are tripped.

Before setting the OVP or OCP level:

- Ensure the load is not connected.
- Ensure the output is set to off.

1. Press the OVP/OCP key. The OVP/OCP key lights up. 
2. The OVP setting will be displayed on the top and the OCP setting will be displayed on the bottom.

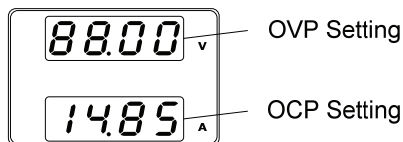

OVP Level

3. Use the voltage knob to set the OVP level.

Range 10%~110% of rated output voltage.

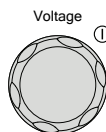



OCP Level

4. Use the current knob to set the OCP level.

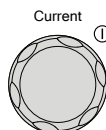
Range 10%~110% of rated output current.



5. Press OVP/OCP again to exit. The OVP/OCP indicator will turn off. 

- Power switch trip  6. Set F-95 (Power switch trip) to 1 (to disable the power switch trip) or to 0 (to enable the power switch trip) and save.

F-95 1 (Disable) or 0 (Enable)

## Set to C.V. Mode

When setting the power supply to constant voltage mode, a current limit must also be set to determine the crossover point. When the current exceeds the crossover point, the mode switches to C.C. mode. For details about C.V. operation, see page 20. C.C. and C.V. mode have two selectable slew rates: High Speed Priority and Slew Rate Priority. High Speed Priority will use the fastest slew rate for the instrument while Slew Rate Priority will use a user-configured slew rate.

---

**Background** Before setting the power supply to C.V. mode, ensure:

- The output is off.
- The load is connected.

**Steps**

1. Press the Function key. The Function key will light up.
 



2. Set F-03 (V-I Mode Slew Rate Select) to 0 (CV High Speed Priority) or 2 (CV Slew Rate Priority) and save.
 

Page 84

F-03      0 = CV High Speed Priority  
            2 = CV Slew Rate Priority
3. If CV slew rate priority was chosen Page 84 as the operating mode, set F-04 (Rising Voltage Slew Rate) and the F-05 (Falling Voltage Slew Rate) and save.
 

F-04      0.1V/s~60V/s (PSW 30-XX)  
F-05      0.1V/s~160V/s (PSW 80-XX)

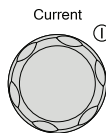
4. Use the Current knob to set the current limit (crossover point).



5. Use the Voltage knob to set the voltage.

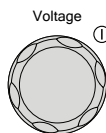

Notice the Set key becomes illuminated when setting the current or voltage. If the voltage or current knobs are unresponsive, press the Set key first.

6. Press the Output key. The Output key becomes illuminated.

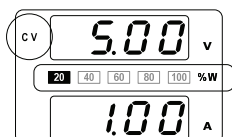
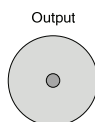

CV and the Power Bar will become illuminated (top left & center)



Only the voltage level can be altered when the output is on. The current level can only be changed by pressing the Set key.

## Set to C.C. Mode

When setting the power supply to constant current mode, a voltage limit must also be set to determine the crossover point. When the voltage exceeds the crossover point, the mode switches to C.V. mode. For details about C.C. operation, see page 20. C.C. and C.V. mode have two selectable slew rates: High Speed Priority and Slew Rate Priority. High Speed Priority will use the fastest slew rate for the instrument while Slew Rate Priority will use a user-configured slew rate.

Background	Before setting the power supply to C.C. mode, ensure: <ul style="list-style-type: none"> <li>• The output is off.</li> <li>• The load is connected.</li> </ul>	
Steps	1. Press the Function key. The Function key will light up.	Function 
	2. Set F-03 (V-I Mode Slew Rate Select) to 1 (CC High Speed Priority) or 3 (CC Slew Rate Priority) and save.  F-03      1 = CC High Speed Priority 3 = CC Slew Rate Priority	Page 84
	3. If CC Slew Rate Priority was chosen as the operating mode, set F-06 (Rising Current Slew Rate) and F-07 (Falling Current Slew Rate) and save.	Page 84

- F-06 0.01A/s~72.00A/s (PSW 30-36)
- F-07 0.01A/s~144.0A/s (PSW 30-72)
- 0.01A/s~216.0A/s (PSW 30-108)
- 0.01A/s~27.00A/s (PSW 80-13.5)
- 0.01A/s~54.00A/s (PSW 80-27)
- 0.01A/s~81.00A/s (PSW 80-40.5)

4. Use the Voltage knob to set the voltage limit (crossover point).

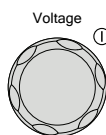

5. Use the Current knob to set the current.

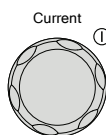

Note

Notice the Set key becomes illuminated when setting the current or voltage. If the voltage or current knobs are unresponsive, press the Set key first.

6. Press the Output key. The Output key becomes illuminated.

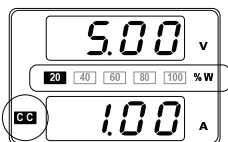
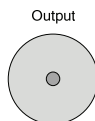

CC and the Power Bar will become illuminated (bottom left & center)



Note

Only the current level can be altered when the output is on. The voltage level can only be changed by pressing the Set key.



## Display Modes

The PSW power supplies allow you to view the output in three different modes: voltage and current, voltage and power or current and power.

1. Press the PWR/DSPL key. The PWR DSPL key lights up.

PWR DSPL



2. The display changes to voltage and power (V/W).
3. To switch between displaying A/W and V/W, simply press the corresponding voltage or current knob.

For example: when in A/W mode, press the voltage knob to display V/W. Conversely when in V/W mode, press the current knob to display A/W.

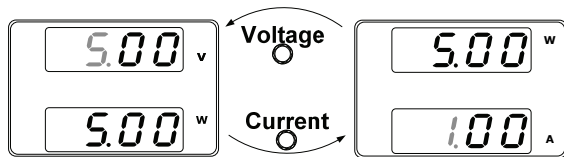

- When V/W is displayed, the voltage knob can still be used to change the voltage level.
- When A/W is displayed, the current knob can still be used to change the current level.

Exit

Press the PWR/DSPL key again to return to normal display mode. The PWR DSPL light will turn off.

PWR DSPL



## Panel Lock

The panel lock feature prevents settings from being changed accidentally. When activated, the Lock/Local key will become illuminated and all keys and knobs except the Lock/Local key and Output key (if active) will be disabled.

If the instrument is remotely controlled via the USB/LAN interface, the panel lock is automatically enabled.

---

Activate the panel lock	Press the Lock/Local key to activate the panel lock. The key will become illuminated.	Lock/Local 
-------------------------	---	---

---

Disable the panel lock	Hold the Lock/Local key for ~3 seconds to disable the panel lock. The Lock/Local light turns off.	Lock/Local 
------------------------	---	---

## Remote Sense

Remote sense is used to compensate for the voltage drop seen across load cables due to the resistance inherent in the load cables. The remote sense terminals are connected to the load terminals to determine the voltage drop across the load cables.

Remote sense can compensate up to 0.6 volts (compensation voltage). Load cables should be chosen with a voltage drop less than the compensation voltage.

---



**WARNING**

Ensure the output is off before connecting any sense cables.

Use sense cables with a voltage rating exceeding the isolation voltage of the power supply.

Never connect sensing cables when the output is on. Electric shock or damage to the power supply could result.



**Note**

Be sure to remove the Sense joining plates so the units are not using local sensing.

**Single Load**

1. Connect the Sense+ terminal to the positive potential of the load. Connect the Sense- terminal to the negative potential of the load.

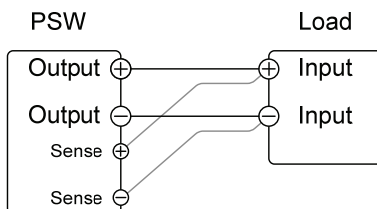

Page 38

2. Operate the instrument as normal. Page 43 See the Basic Operation chapter for details.

Parallel PSW Units

1. Connect the Sense+ terminals to the positive potential of the load. Connect the Sense- terminals to the negative potential of the load.

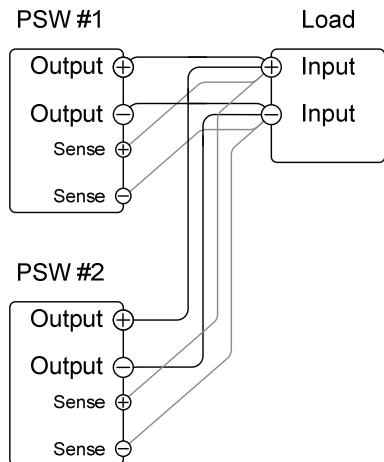

Page 38

2. Operate the instrument as normal. Page 55  
See the Parallel Operation chapter for details.

Serial PSW Units

1.
  - a. Connect the 1<sup>st</sup> Sense+ terminal to the positive potential of the load.
  - b. Connect the 1<sup>st</sup> Sense- terminal to the positive output terminal of the second PSW unit.
  - c. Connect the 2<sup>nd</sup> Sense+ terminal to the positive terminal of the second PSW unit.
  - d. Connect the 2<sup>nd</sup> Sense- terminal to negative terminal of the load.

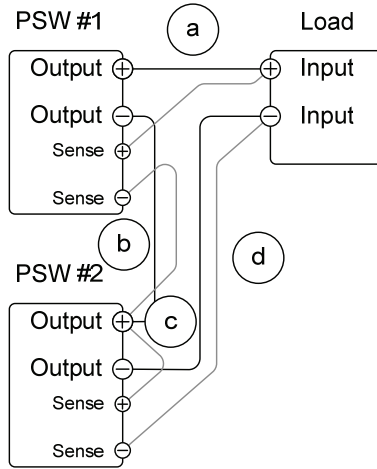

2. Operate the instrument as normal. Page 61  
See the Serial Operation chapter for details.

Wire Shielding and Load line impedance

To help to minimize the oscillation due to the inductance and capacitance of the load cables, use an electrolytic capacitor in parallel with the load terminals.

To minimize the effect of load line impedance use twisted wire pairing.

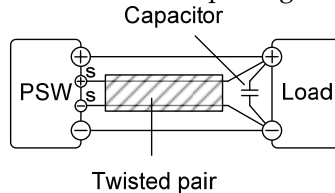

## Parallel / Series Operation

This section describes the basic operations required to operate the power supply in series or parallel. Operating the PSW series in parallel increases the total power output of the power supply units. When used in series, the total output voltage of the power supplies can be increased.

The number of the power supplies that can be connected in series or parallel depends on the model and the mode:

- Series Mode: 2 units maximum
- Parallel Mode: 3 units maximum

To use the power supplies in series or parallel, units must be used in a Master-Slave configuration. In the master-slave configuration a “master” power supply controls any other connected “slave” power supplies.

- Master-Slave Parallel overview → from page 55
- Parallel connection → from page 56
- Parallel operation → from page 59
- Master-Slave Series overview → page 61
- Series connection → page 62
- Series operation → from page 64

Before operating the power supply, please see the Getting Started chapter, page 9.

## Master-Slave Parallel Overview

---

Description	<p>When connecting the PSW power supplies in parallel, up to 3 units can be used in parallel and all units must be of the same model.</p> <p>When the units are used in parallel, a number of precautions and limitations apply. Please read this overview before operating the power supplies in parallel.</p>
Limitations	<p>Display</p> <ul style="list-style-type: none"><li>• Only the master unit will display the voltage and current.</li></ul> <p>OVP/ OCP</p> <ul style="list-style-type: none"><li>• The master unit can shut down slave units when OVP/OCP is tripped on the master unit (if the slave connector is wired for shut down on alarm).</li><li>• OVP/OCP can be independently tripped on each slave unit, however the shutdown of the power or output of the unit is disabled. Only the alarm will be enabled.</li></ul> <p>Remote monitoring</p> <ul style="list-style-type: none"><li>• Voltage monitoring (VMON) and current monitoring (IMON) are only supported on the master unit.</li></ul> <p>Remote Sense</p> <ul style="list-style-type: none"><li>• Please see the remote sense chapter for details, page 50.</li></ul> <p>Voltage controlled remote control</p> <ul style="list-style-type: none"><li>• Voltage controlled remote control can only be used with the master unit.</li></ul>

	Model	Single unit	2 units	3 units
Output Voltage/ Output Current	PSW 30-36	30V	30V	30V
		36A	72A	108A
	PSW 80-13.5	80V	80V	80V
		13.5A	27A	40.5A
	PSW 30-72	30V	30V	30V
		72A	144A	216A
	PSW 80-27	80V	80V	80V
		27A	54A	81A
	PSW 30-108	30V	30V	30V
		108A	216A	324A
	PSW 80-40.5	80V	80V	80V
		40.5A	81A	121.5A

### Master-Slave Parallel Connection

---

Master-Slave  
Connector

The Analog Control Connector is used for both serial and parallel connections. The way the connector is configured determines the behavior of the master and slave units. For the complete connector pin assignment, see page 89.

---

Analog Connector  
Connection

To operate the power supplies in parallel, connect the analog connectors on the master and slave units as shown in the diagrams below.



Master with 2 slave units:

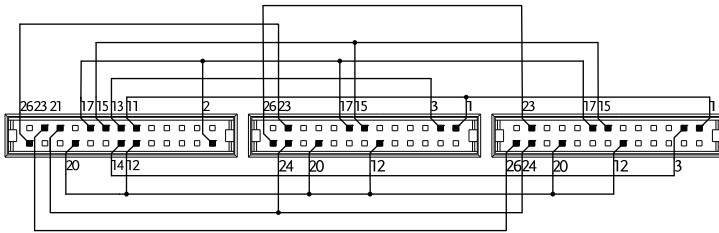

Master unit		Slave Unit 1		Slave Unit 2	
11	I MON	1	CURRENT SHARE	1	CURRENT SHARE
21	OUTPUT ON STATUS	24	OUT ON/OFF CONT	24	OUT ON/OFF CONT
20	ALM STATUS	12	SHUTDOWN	12	SHUTDOWN
17	STATUS COM	17	STATUS COM	17	STATUS COM
15	FEEDBACK	15	FEEDBACK	15	FEEDBACK
14	CURRENT_SUM_2	3	CURRENT SUM OUT	3	CURRENT SUM OUT
13	CURRENT_SUM_1	20	ALM STATUS	20	ALM STATUS
12	SHUTDOWN	23	DETECT IN	23	DETECT IN
2	D COM	26	DETECT OUT	26	DETECT OUT
26	DETECT OUT				
23	DETECT IN				

Master with 1 slave unit:

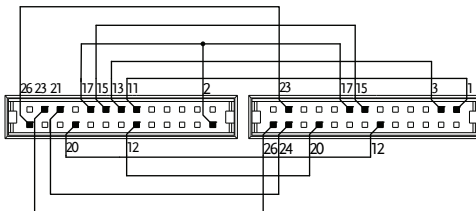

Master unit		Slave Unit 1	
11	I MON	1	CURRENT SHARE
21	OUTPUT ON STATUS	24	OUT ON/OFF CONT
20	ALM STATUS	12	SHUTDOWN
17	STATUS COM	17	STATUS COM
15	FEEDBACK	15	FEEDBACK
13	CURRENT_SUM_1	3	CURRENT SUM OUT
12	SHUTDOWN	20	ALM STATUS
2	D COM	23	DETECT IN
26	DETECT OUT	26	DETECT OUT
23	DETECT IN		

Parallel Output Connection

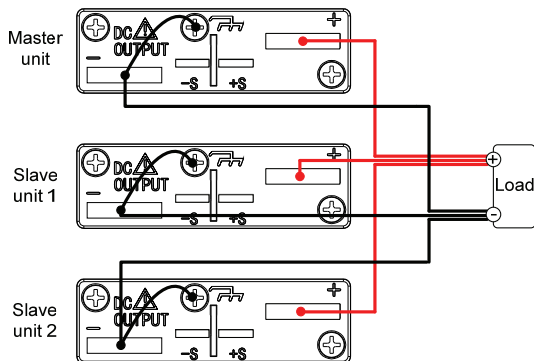

Steps

1. Ensure the power is off on all power supplies.
2. Choose a master and a slave unit(s).
3. Connect the analog connectors for the master and slave unit as shown above.
4. Remove the Output Terminal covers and the protection dummy plug from the analog control connector. Page 40
5. Connect the master and slave unit in parallel as shown above.
6. Reattach the terminal covers. Page 40



Note

Ensure the load cables have sufficient Page 37 current capacity.

Re-attach the Protection dummy plug when not in use.

## Master-Slave Parallel Operation

**Master-Slave Configuration** Before using the power supplies in parallel, the master and slave units need to be configured.

1. Configure the OVP and OCP settings for the master unit. Page 43

2. For each unit, hold the Function key while turning the power on to enter the power on configuration settings.

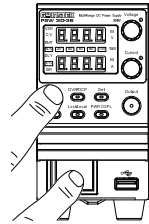

3. Configure F-93 (Master/Slave) setting for each master/slave unit. Page 86

Unit	F-93
Master (with 1 slave in parallel)	1
Master (with 2 slaves in parallel)	2
Slave unit (parallel slave)	3

4. Cycle the power on the units (reset the power).

 **Note**

Configuration settings can be checked for both the master and slave units by pressing the Function key and checking F-93.

Only the Master OVP and OCP level is used for over voltage and current protection. Slave OVP and OCP level is disregarded.

OTP works independently for each unit.

**Master-Slave Operation**

Only operate the power supplies in parallel if the units are configured correctly.

1. Turn on the master and slave units. The slave unit(s) will show a blank display.

Master unit



Slave units

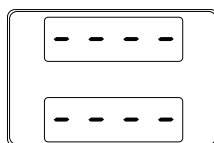

2. Operation of all units is controlled via the master unit. Operation of the master unit is the same as for a single unit. See the Basic Operation chapter.

3. Press the Output key to begin.

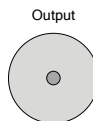

Caution

Only operate the power supplies in parallel if using units of the same model number.

Only a maximum of 3 units can be used in parallel.



Note

The panel controls are disabled on slave units, including the output key. On slave units only the Function key can be used to view the current settings.

## Master-Slave Series Overview

---

**Background**                      When connecting PSW power supplies in series, up to 2 units can be used in series and all units must be of the same model.

When the units are used in series, a number of precautions and limitations apply. Please read this overview before operating the power supplies in series.

---

### Limitations

#### Display

- Only the master unit will display the current.
- Master and slave units display the voltage. The total voltage is the sum of the units.

#### OVP/OCP

- The master unit can shut down the slave unit when OVP/OCP is tripped on the master unit (if the slave connector is wired for shut down on alarm).
- OVP and OCP level is determined by the master OVP and OCP level. The OVP and OCP level on the slave unit is ignored.

#### Remote monitoring

- Voltage monitoring (VMON) and current monitoring (IMON) are only supported on the master unit.

#### Remote Sense

- Please see the remote sense chapter for details, page 50.

Voltage controlled remote control

- Voltage controlled remote control can only be used with the master unit.

	Model	Single unit	2 units
Output Voltage/ Output Current	PSW 30-36	30V	60V
		36A	36A
	PSW 80-13.5	80V	160V
		13.5	13.5A
	PSW 30-72	30V	60V
		72A	72A
	PSW 80-27	80V	160V
		27A	27A
	PSW 30-108	30V	60V
		108A	108A
	PSW 80-40.5	80V	160V
		40.5A	40.5A

## Master-Slave Series Connection

---

Master-Slave Connector

The Analog Control Connector is used for both serial and parallel connections. The way the connector is configured determines the behavior of the master and slave units. For the connector pin assignment, see page 89.

Analog Connector Connection

To operate the power supplies in series, connect the analog connectors on the master and slave unit as shown in the diagram below.

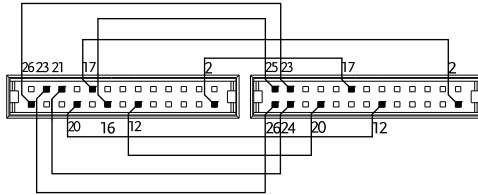

Master unit		Slave Unit 1	
16	A COM	25	SER. SLV IN
21	OUTPUT ON STATUS	24	OUT OFF/ON CONT
20	ALM STATUS	12	SHUTDOWN
17	STATUS COM	2	D COM
12	SHUTDOWN	20	ALM STATUS
2	D COM	17	STATUS COM
26	DETECT OUT	23	DETECT IN
23	DETECT IN	26	DETECT OUT

**Series Output Connection**

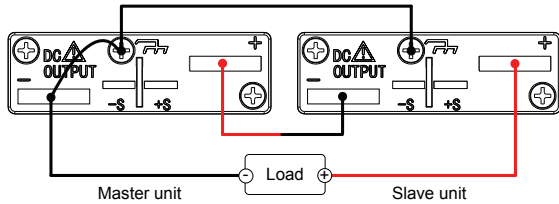

**Steps**

1. Ensure the power is off on both power supplies.
2. Choose a master and slave unit.
3. Connect the analog connectors for the master and slave unit as shown above.
4. Remove the output terminal cover Page 40 and the protection dummy plug from the analog control connector.
5. Connect the master and slave unit in series as shown above.
6. Reattach the terminal cover. Page 40



Note

Ensure load cables have sufficient current capacity. Page 37

Re-attach the protection dummy plug when not in use.

## Master-Slave Series Operation

---

Master-Slave Configuration

Before using the power supplies in series, the master and slave units need to be configured.

1. Configure the OVP and OCP settings for the master unit. Page 43

2. For each unit, hold the Function key while turning the power on to enter the power on configuration settings.

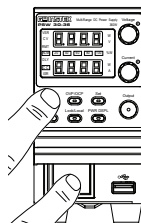

3. Configure F-93 (Master/Slave) setting for each master/slave unit. Page 86

Unit	F-93
Master (local or series operation)	0
Slave unit (series)	4

4. Cycle the power on the units (reset the power).



Note

Configuration settings can be checked for both the master and slave units by pressing the Function key.

Master-Slave Operation

Only operate the power supplies in series if the units are configured correctly.



1. Turn on the master and slave unit. The slave unit will only show the voltage.

Master unit



Slave units

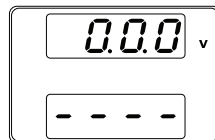

2. Operation of all units is controlled via the master unit. Operation of the master unit is the same as for a single unit. Please see the basic operation chapter for details.
3. Press the Output key to begin.

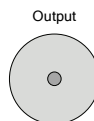

Only operate the power supplies in series if using units of the same model number.

Only a maximum of 2 units can be used in series.



The panel controls are disabled on slave units, including the output key.

## Test Scripts

This section describes how to use the Test function to run, load and save test scripts for automated testing. The Test function is useful if you want to perform a number of tests automatically. The PSW test function can store ten test scripts in memory.

Each test script is programmed in a scripting language. For more information on how to create Test Scripts, please see the programming manual.

- Test script file structure → from page 67
- Load Test Script → from page 69
- Run Test Script → from page 70
- Export Test Script → from page 71
- Remove Test Script → from page 72

## Test Script File Format

---

Description	The test files are saved in *.tst file format.  Each file is saved as tXXX.tst, where XXX is the save file number 001~010.
-------------	--

## Test Script Settings

---

Test Run	Runs the chosen test script from the internal memory. A script must first be loaded into the internal memory before it can be run. See the test function Test Save, below.  The script will run as soon as the test function is started.
	T-01                      1~10
Test Load	Loads a test script from the USB drive to the designated save slot in memory. A script must first be loaded into internal memory before it can be run.
	T-02                      1~10 (USB→PSW)
Test Export	Exports a script from the designated memory save slot to the USB drive.
	T-03                      1~10 (PSW→USB)
Test Remove	Deletes the chosen test file from the PSW internal memory.
	T-04                      1~10

## Setting the Test Function Settings

**Steps**                      The test script settings (T-01~T-04) are set with the Test key.

1. Press the Test key. The Test key will light up.



2. The display will show T-01 on the top and the memory no. for T-01 on the bottom.

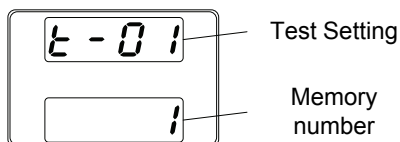

3. Rotate the voltage knob to change the T setting (Test setting).

Test Run	T-01
Test Load	T-02
Test Export	T-03
Test Remove	T-04

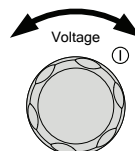

4. Rotate the current knob to choose a memory number.

Range	1~10
-------	------

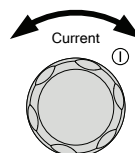

5. Press the Voltage knob to complete the setting.

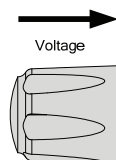

Exit Press the Test key again to exit the Test settings. The Test key light will turn off.



## Load Test Script from USB

---

Overview Before a test script can be run, it must first be loaded into a one of the 10 memory save slots. Before loading a test script into memory:

- Ensure the script file is placed in the root directory.
- Ensure the file name number corresponds to the memory number that you wish to save to.

For example: A test file named t001.tst can only be saved to memory number 01, t002.tst can only be saved to memory number 02, and so on.

- Steps
1. Insert a USB flash drive into the front panel USB-A slot. Ensure the flash drive contains a test script in the root directory.
  2. Turn on the power. MS (Mass Storage) will be displayed on the screen after a few seconds if the USB drive is recognized.

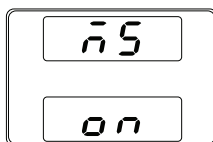
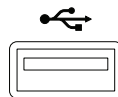



Note

If the USB drive is not recognized, check to see that the function settings for F-20 = 1 (page 80). If not, reinsert the USB flash drive.

3. Configure T-02 (Test Load) to 1~10 Page 68 (save memory slot)  
T-02 range 1~10 (t001 ~t010)
4. The script will now be available in the memory slot the script was saved to.



Note

Error messages: If you load a file that is not present on the USB drive “Err 002” will be displayed on the display.

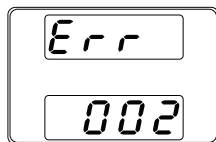

## Run Test Script

---

### Overview

A test script can be run from one of ten memory slots.

1. Before a test script can be run, it must first be loaded into one of the 10 memory save slots. Page 69
2. Configure T-01 (Run Test) to 1~10 Page 68 (save memory slot)  
T-01 range 1~10
3. The test script will automatically start to run.

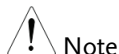

Note

Error messages: If you try to run a test script from an empty memory location “Err 003” will be displayed on the display.

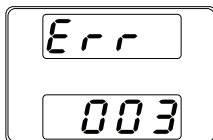

Note

When a script starts to run, there is no way to abort the script. Pressing the Output key has no effect. If you wish to stop a test early, turn the power off.

## Export Test Script to USB

---

### Overview

The Export Test function saves a test file to the root directory of a USB flash drive.

- Files will be saved as tXXX.tst where XXX is the memory number 001~010 from which the test script was exported from.
- Files of the same name on the USB flash drive will be written over.

### Steps

1. Insert a USB flash drive into the front panel USB-A slot.

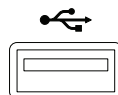

2. Turn on the power. MS (Mass Storage) will be displayed on the screen after a few seconds if the USB drive is recognized.

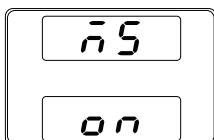



Note

If the USB drive is not recognized, check to see that the function settings for F-20 = 1 (page 80). If not, reinsert the USB flash drive.

3. Configure T-03 (Test Export) to Page 68  
0~10 (save memory slot)  
T-03 range 1~10
4. The script will now be copied to the USB flash drive.



Note

Error messages: If you try to export a test script from an empty memory location “Err 003” will be displayed on the display.



## Delete Test Script

---

Overview

The Remove Test function will delete a test script from the internal memory.

1. Select T-04 (Test Remove) and Page 68  
choose which test script to remove  
from the internal memory.  
T-04 range 1~10
2. The test script will be removed from the  
internal memory.





Error messages: If you try to remove a test script from an empty memory location “Err 003” will be displayed on the display.

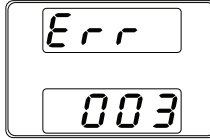

# C ONFIGURATION

---

<b>Configuration .....</b>	<b>75</b>
Configuration Table .....	75
Normal Function Settings .....	78
USB/GPIB Settings .....	80
LAN Settings .....	81
Power On Configuration Settings .....	83
Calibration .....	84

## Configuration

Configuration of the PSW power supplies is divided into five different configuration settings: Normal Function, USB/GPIB, LAN, Power ON Configuration and Calibration Settings. Power ON Configuration differs from the other settings in that the settings used with Power ON Configuration settings can only be set during power up. The other configuration settings can be changed when the unit is already on. This prevents some important configuration parameters from being changed inadvertently. Power On Configuration settings are numbered F-90 to F-95 and the other configuration settings are numbers F-00 to F-61.

### Configuration Table

Please use the configuration settings listed below when applying the configuration settings.

Normal Function Settings		
Settings	Setting	Setting Range
Output ON delay time	F-01	0.00s~99.99s
Output OFF delay time	F-02	0.00s~99.99s
V-I mode slew rate select	F-03	0 = CV high speed priority 1 = CC high speed priority 2 = CV slew rate priority 3 = CC slew rate priority
Rising voltage slew rate	F-04	0.01V/s~60.00V/s (PSW 30-XX) 0.1V/s~160.0V/s (PSW 80-XX)
Falling voltage slew rate	F-05	0.01V/s~60.00V/s (PSW 30-XX) 0.1V/s~160.0V/s (PSW 80-XX)
Rising current slew rate	F-06	0.01A/s~72.00A/s (PSW 30-36) 0.1A/s~144.0A/s (PSW 30-72) 0.1A/s~216.0A/s (PSW 30-108) 0.01A/s~27.00A/s (PSW 80-13.5) 0.01A/s~54.00A/s (PSW 80-27) 0.01A/s~81.00A/s (PSW 80-40.5)

Falling current slew rate	F-07	0.01A/s~72.00A/s (PSW 30-36) 0.1A/s~144.0A/s (PSW 30-72) 0.1A/s~216.0A/s (PSW 30-108) 0.01A/s~27.00A/s (PSW 80-13.5) 0.01A/s~54.00A/s (PSW 80-27) 0.01A/s~81.00A/s (PSW 80-40.5)
Internal resistance setting	F-08	0.000Ω~0.833Ω (PSW 30-36) 0.000Ω~0.417Ω (PSW 30-72) 0.000Ω~0.278Ω (PSW 30-108) 0.000Ω~5.926Ω (PSW 80-13.5) 0.000Ω~2.963Ω (PSW 80-27) 0.000Ω~1.975Ω (PSW 80-40.5)
Bleeder circuit control	F-09	0 = OFF, 1 = ON
Buzzer ON/OFF control	F-10	0 = ON, 1 = OFF
<b>USB/GPIB settings</b>		
Front panel USB State	F-20	0 = Absent, 1 = Mass Storage
Rear panel USB State	F-21	0 = Absent, 2 = USB-CDC, 3 = GPIB-USB adapter
Rear panel USB mode	F-22	0 = Disable, 1 = GPIB-USB adapter, 2 = USB CDC
GPIB address	F-23	0~30
<b>LAN settings</b>		
MAC Address-1	F-30	0x00~0xFF
MAC Address-2	F-31	0x00~0xFF
MAC Address-3	F-32	0x00~0xFF
MAC Address-4	F-33	0x00~0xFF
MAC Address-5	F-34	0x00~0xFF
MAC Address-6	F-35	0x00~0xFF
LAN	F-36	0 = Disable, 1 = Enable
DHCP	F-37	0 = Disable, 1 = Enable
IP Address-1	F-39	0~255
IP Address-2	F-40	0~255
IP Address-3	F-41	0~255
IP Address-4	F-42	0~255
Subnet Mask-1	F-43	0~255
Subnet Mask-2	F-44	0~255
Subnet Mask-3	F-45	0~255
Subnet Mask-4	F-46	0~255
Gateway-1	F-47	0~255
Gateway-2	F-48	0~255

Gateway-3	F-49	0~255
Gateway-4	F-50	0~255
DNS address -1	F-51	0~255
DNS address -2	F-52	0~255
DNS address-3	F-53	0~255
DNS address-4	F-54	0~255
Sockets active	F-57	0 = Disable, 1 = Enable
Web Server active	F-59	0 = Disable, 1 = Enable
Web password active	F-60	0 = Disable, 1 = Enable
Web setting password	F-61	0000~9999
<b>Power On Configuration Settings*</b>		
CV Control	F-90	0 = Panel control (local)
		1 = External voltage control
		2 = External resistance control (Ext-R $\searrow$ 10k $\Omega$ = V <sub>o</sub> , max)
		3 = External resistance control (Ext-R $\nearrow$ 10k $\Omega$ = 0)
CC Control	F-91	0 = Panel control (local)
		1 = External voltage control
		2 = External resistance control (Ext-R $\searrow$ 10k $\Omega$ = I <sub>o</sub> ,max)
		3 = External resistance control (Ext-R $\nearrow$ 10k $\Omega$ = 0)
Power-ON Output	F-92	0 = OFF at startup, 1 = On at startup
Master/Slave	F-93	0 = Master/Local
		1 = Master/Parallel1
		2 = Master/Parallel2
		3 = Slave/Parallel
		4 = Slave/Series
External Out Logic	F-94	0 = High ON, 1 = Low ON
Power Switch trip	F-95	0 = Enable , 1 = Disable
<b>Calibration Settings*</b>		
Calibration	F-00	0000 ~ 9999

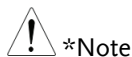

\*Note

Power On and Calibration settings can only be set during power up.

## Normal Function Settings

**Output ON Delay Time** Delays turning the output on for a designated amount of time. The Delay indicator will light when the Delay time is not 0.

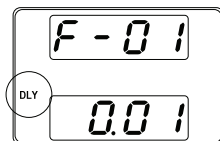

F-01                      0.00s~99.99s

**Output OFF Delay Time** Delays turning the output off for a designated amount of time. The Delay indicator will light when the Delay time is not 0.

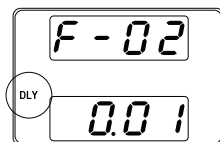

F-02                      0.00s~99.99s

**V-I Mode** Selects High Speed Priority, or Slew Rate Priority CV or CC mode. The voltage or current slew rate can only be edited if CC/CV Slew Rate Priority is selected. The ISR indicator will be lit for CC Slew Rate Priority and the VSR indicator will be lit for CV Slew Rate Priority.

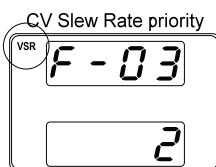
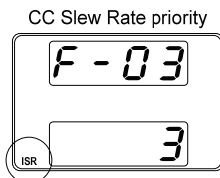

	F-03	0 = CV high speed priority 1 = CC high speed priority 2 = CV slew rate priority 3 = CC slew rate priority
Rising Voltage Slew Rate		Sets the rising voltage slew rate. Only applicable if V-I Mode is set to CV Slew Rate Priority.
	F-04	0.01V/s~60V/s (PSW 30-XX) 0.1V/s~160V/s (PSW 80-XX)
Falling Voltage Slew Rate		Sets the falling voltage slew rate. Only applicable if V-I Mode is set to CV Slew Rate Priority.
	F-05	0.01V/s~60V/s (PSW 30-XX) 0.1V/s~160V/s (PSW 80-XX)
Rising Current Slew Rate		Sets the rising current slew rate. Only applicable if V-I Mode is set to CC Slew Rate Priority.
	F-06	0.01A/s~72.00A/s (PSW 30-36) 0.1A/s~144.0A/s (PSW 30-72) 0.1A/s~216.0A/s (PSW 30-108) 0.01A/s~27.00A/s (PSW 80-13.5) 0.01A/s~54.00A/s (PSW 80-27) 0.01A/s~81.00A/s (PSW 80-40.5)
Falling Current Slew Rate		Sets the falling current slew rate. Only applicable if V-I Mode is set to CC Slew Rate Priority.
	F-07	0.01A/s~72.00A/s (PSW 30-36) 0.1A/s~144.0A/s (PSW 30-72) 0.1A/s~216.0A/s (PSW 30-108) 0.01A/s~27.00A/s (PSW 80-13.5) 0.01A/s~54.00A/s (PSW 80-27) 0.01A/s~81.00A/s (PSW 80-40.5)

Internal Resistance Settings	Sets the internal resistance of the power supply. F-08	0.000Ω~0.833Ω (PSW 30-36) 0.000Ω ~0.417Ω (PSW 30-72) 0.000Ω ~0.278Ω (PSW 30-108) 0.000Ω ~5.926Ω (PSW 80-13.5) 0.000Ω ~2.963Ω (PSW 80-27) 0.000Ω ~1.975Ω (PSW 80-40.5)
------------------------------	---	--

Bleeder Control	Bleeder control turns ON/OFF the bleeder resistor. Bleeder resistors discharge the filter capacitors after power is turned off as a safety measure. F-09	0 = OFF, 1 = ON
-----------------	---	-----------------

Buzzer ON/OFF	Turns the buzzer sound on or off. The buzzer is associated with alarm sounds and keypad entry sounds. F-10	0 = ON, 1 = OFF
---------------	---	-----------------

### USB/GPIB Settings

Front Panel USB State	Displays the front panel USB-A port state. This setting is not configurable. F-20	0 = Absent, 1 = Mass Storage
-----------------------	--	------------------------------

Rear Panel USB State	Displays the rear panel USB-B port state. This setting is not configurable. F-21	0 = Absent, 2 = USB-CDC, 3 = GPIB-USB adapter
----------------------	---	--

Rear Panel USB Mode	Sets the rear panel USB mode. F-22	0 = Disable, 1 = GPIB-USB adapter (for GUG-001), 2 = USB CDC
---------------------	---------------------------------------	---

GPIB Address	Sets the GPIB address. F-23	0~30
--------------	--------------------------------	------



LAN Settings

---

MAC Address-1~6	Displays the MAC address 1~6. This setting is not configurable. F-30~F-35      0x00~0xFF
LAN	Turns Ethernet on or off. F-36      0 = Disable, 1 = Enable
DHCP	Turns DHCP on or off. F-37      0 = Disable, 1 = Enable
IP Address-1~4	Sets the default IP address. IP address 1~4 splits the IP address into four sections. (F-39 : F-40 : F-41 : F-42) (0~255 : 0~255 : 0~255 : 0~255)
Subnet Mask 1~4	Sets the subnet mask. The subnet mask is split into four parts. (F-43 : F-44 : F-45 : F-46) (0~255 : 0~255 : 0~255 : 0~255)
Gateway 1~4	Sets the gateway address. The gateway address is split into 4 parts. (F-47 : F-48 : F-49 : F-50) (0~255 : 0~255 : 0~255 : 0~255)
DNS Address 1~4	Sets the DNS address. The DNS address is split into 4 parts. (F-51 : F-52 : F-53 : F-54) (0~255 : 0~255 : 0~255 : 0~255)
Sockets active	Enables WebSocket connections. F-57      0 = Disable, 1 = Enable
Web server active	Turns Web server control on/off. F-59      0 = Disable, 1 = Enable

Web Password active	Turns a web password on/off.
	F-60                      0 = Disable, 1 = Enable
Web Password	Sets the Web password.
	F-61                      0000 ~ 9999

## Power On Configuration Settings

---

CV Control	<p>Sets the constant voltage (CV) control mode between local and external voltage/resistance control. For external voltage control, see page 91 (External Voltage Control of Voltage Output) and page 95 (External Resistance Control of Voltage Output).</p> <p>F-90                    0= Panel control (local)                                      1 = External voltage control                                      2 = External resistance control                                      (Ext-R<math>\searrow</math> 10k<math>\Omega</math> = V<sub>o,max</sub>)                                      3 = External resistance control                                      (Ext-R<math>\searrow</math> 10k<math>\Omega</math> = 0)</p> <hr/>
CC Control	<p>Sets the constant current (CC) control mode between local and external voltage/resistance control. For details on external voltage control, see page 93 (External Voltage Control of Current Output) and 97 (External Resistance Control of Current Output).</p> <p>F-91                    0= Panel control (local)                                      1 = External voltage control                                      2 = External resistance control                                      (Ext-R<math>\searrow</math> 10k<math>\Omega</math> = I<sub>o,max</sub>)                                      3 = External resistance control                                      (Ext-R<math>\searrow</math> 10k<math>\Omega</math> = 0)</p> <hr/>
Power-ON Output	<p>Sets the power supply to turn the output on or off at power up.</p> <p>F-92                    0 = OFF at startup, 1 = On at start up</p> <hr/>
Master/Slave	<p>Sets the power supply as master or slave. See the parallel/series operation for details, page 54.</p>

	F-93	0 = Master/Local 1 = Master/Parallel1 2 = Master/Parallel2 3 = Slave/Parallel 4 = Slave/Series
External Out Logic	F-94	0= High ON, 1 = Low ON
Power Switch Trip	F-95	1 = Disable, 0 = Enable

## Calibration

Programmable Calibration	The calibration password is used to access the local mode calibration or other special functions. The password used determines which function is accessed. Please see your distributor for details.	
	F-00	0000 ~ 9999

## Setting Normal Function Settings

The normal configuration settings (F-01~F-61) can be easily changed with the Function key.

- Ensure the load is not connected.
- Ensure the output is off.



Note

Configuration settings F-90~F-95 cannot be edited in the Normal Function Settings. Use the Power On Configuration Settings. See page 86 for details.

1. Press the Function key. The function key will light up.

Function



2. The display will show F-01 on the top and the configuration setting for F-01 on the bottom.



3. Rotate the voltage knob to change the F setting.

Range F-00~ F-95

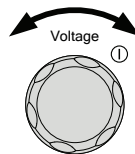

4. Use the current knob to set the parameter for the chosen F setting.

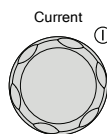

5. Press the Voltage knob to save the configuration setting. Save will be displayed when successful.

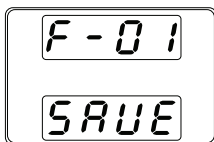
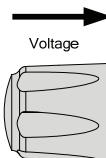

Exit

Press the Function key again to exit the configuration settings. The function key light will turn off.

Function



## Setting Power On Configuration Settings

The Power On configuration settings can only be changed during power up to prevent the configuration settings being inadvertently changed.

- Ensure the load is not connected.
- Ensure the power supply is off.

1. Hold the Function key whilst turning the power on.
2. The display will show F-90 on the top and the configuration setting for F-90 on the bottom.

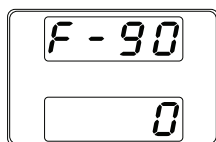
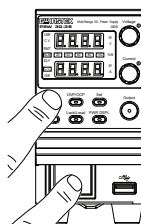

3. Rotate the voltage knob to change the F setting.

Range F-90~ F-95

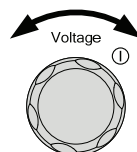

4. Use the current knob to set the parameter for the chosen F setting.

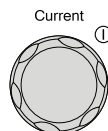

5. Press the Voltage knob to save the configuration setting. ConF will be displayed when successful.

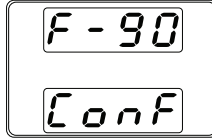
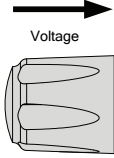

---

Exit

Cycle the power to save and exit the configuration settings.

# A ANALOG CONTROL

The Analog Control chapter describes how to control the voltage or current output using an external voltage or resistance, monitor the voltage or current output as well as remotely turning off the output or shutting down the power supply.

---

<b>Analog Remote Control Overview .....</b>	<b>89</b>
Analog Control Connector Overview.....	89
External Voltage Control of Voltage Output .....	91
External Voltage Control of Current Output .....	93
External Resistance Control of Voltage Output .....	95
External Resistance Control of Current Output .....	97
External Control of Output .....	99
External control of Shutdown .....	102
<b>Remote Monitoring .....</b>	<b>104</b>
External Voltage and Current Monitoring .....	104
External Operation and Status Monitoring.....	106



## Analog Remote Control Overview

The PSW power supply series have a number of analog control options. The Analog Control connectors are used to control output voltage and current using external voltage or resistance. The power supply output and power switch can also be controlled using external switches.

- Analog Control connector overview → from page 89
- External voltage control of voltage output → from page 91
- External voltage control of current output → from page 93
- External resistance control of voltage output → from page 95
- External resistance control of current output → from page 97
- External control of output → from page 99
- External control of the power switch → from page 102

## Analog Control Connector Overview

**Overview**                      The Analog Control Connector is a standard Mil 26 pin connector (OMRON XG4 IDC plug). The connector is used for all analog remote control. The pins used determine what remote control mode is used.

 **WARNING**                      To prevent electric shock, ensure that the cover for the Analog Control Connector is used when the connector is not in use.

**Pin Assignment**

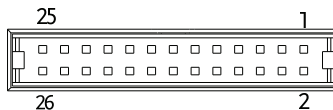

Pin name	Pin number	Description
Current Share	1	Used when operating 2 or more units in parallel.

D COM	2	Connected to the (-S) sense- terminal when remote sense is used. Connected to the negative output terminal when remote sense is not used.
CURRENT SUM OUT	3	Current sum output signal when used in parallel mode.
EXT-V CV CONT	4	External voltage control of the voltage output. A voltage of 0~10V is used to control the full scale voltage output (0%~100%) of the instrument.
EXT-V CC CONT	5	External voltage control of the current output. A voltage of 0~10V is used to control the full scale current output (0%~100%) of the instrument
EXT-R CV CONT PIN1	6	External resistance control of the voltage output. A resistance of 0k $\Omega$ ~ 10k $\Omega$ is used to control the full scale voltage output (0%~100%) of the instrument.
EXT-R CV CONT PIN2	7	External resistance control of the voltage output. A resistance of 0k $\Omega$ ~ 10k $\Omega$ is used to control the full scale voltage output (0%~100%) of the instrument.
EXT-R CC CONT PIN1	8	External resistance control of the current output. A resistance of 0k $\Omega$ ~ 10k $\Omega$ is used to control the full scale current output (0%~100%) of the instrument.
EXT-R CC CONT PIN2	9	External resistance control of the current output. A resistance of 0k $\Omega$ ~ 10k $\Omega$ is used to control the full scale current output (0%~100%) of the instrument.
V MON	10	Voltage Monitor Output. Outputs the full scale voltage (0~100%) as a voltage (0V~10V).
I MON	11	Current Monitor Output. Outputs the full scale current (0~100%) as a voltage (0V~10V).
SHUTDOWN	12	The shut down signal will turn off the output or power when a low TTL signal is applied. The shutdown signal is pulled up to 5V with a 10k $\Omega$ pull-up resistor.
CURRENT_SUM_1	13	Master unit current sum input signal from first slave CURRENT SUM OUTPUT. Used in parallel mode only.
CURRENT_SUM_2	14	Master unit current sum input signal from second slave CURRENT SUM OUTPUT. Used in parallel mode only.
FEEDBACK	15	Parallel control signal during master-slave parallel operation.

A COM	16	Analog signal common. Connected to the sense-terminal when remote sense is used. Connected to the negative output terminal when remote sense is not used.
STATUS COM	17	Common for status signals 18, 19, 20, 21 and 22.
CV STATUS	18	Turns on when CV mode is active. (photo coupled open collector output)
CC STATUS	19	Turns on when CC mode is active. (photo coupled open collector output)
ALM STATUS	20	Turns on when any of the protection modes are tripped (OVP, OCP) or if a shutdown signal is input. (photo coupled open collector output)
OUTPUT ON STATUS	21	Turns on when the output has been turned on. (photo coupled open collector output)
POWER OFF STATUS	22	Turns on when the power switch is turned off.
DETECT IN	23	Input to detect for series/parallel mode connection.
OUT ON/OFF CONT	24	Turns the output on/off when (default setting) a low TTL signal is applied. Internally, the circuit is pulled up to +5V with 10kΩ resistance.
SER SLV IN	25	Series slave input during master-slave series operation.
DETECT OUT	26	Input to detect for series/parallel connection.

## External Voltage Control of Voltage Output

**Description** External voltage control of the voltage output is accomplished using the MIL-26 connector on the rear panel. A voltage of 0~10V is used to control the full scale voltage of the instrument, where:

$$\text{Output voltage} = \text{full scale voltage} \times (\text{external voltage}/10)$$

**Connection**

When connecting the external voltage source to the MIL connectors, use shielded or twisted paired wiring.

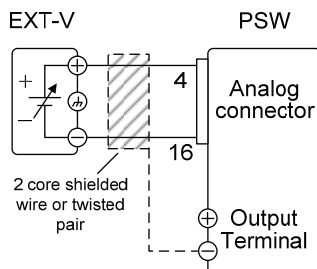

- Pin16 → EXT-V (-)
- Pin4 → EXT-V (+)
- Wire shield → negative (-) output terminal

**Connection- alt. shielding**

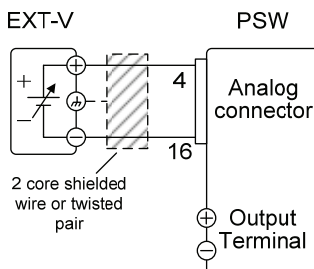

If the wire shield needs to be grounded at the voltage source (EXT-V), then the shield cannot also be grounded at the negative (-) terminal output of the PSW power supply. This would short the output.



- Pin16 → EXT-V(-)
- Pin4 → EXT-V(+)
- Wire shield → EXT-V ground (GND)

**Panel operation**

1. Connect the external voltage according to the connection diagrams above.

2. Set the F-90 power on configuration setting to 1 (CV control - Ext voltage). Page 86
- Be sure to cycle the power after the power on configuration has been set.
3. Press the Function key and confirm the new configuration settings (F-90=1). 
4. Press the Output key. The voltage can now be controlled with the External voltage. 



Note

The input impedance for external voltage control is 10kΩ.

Use a stable voltage supply for the external voltage control.



CAUTION

Ensure no more than 10.5 volts are input into the external voltage input.

Ensure the voltage polarity is correct when connecting the external voltage.

## External Voltage Control of Current Output

### Description

External voltage control of the current output is accomplished using the MIL-26 connector on the rear panel. A voltage of 0~10V is used to control the full scale current of the instrument, where:

Output current = full scale current × (external voltage/10)

**Connection**

When connecting the external voltage source to the MIL connectors, use shielded or twisted paired wiring.

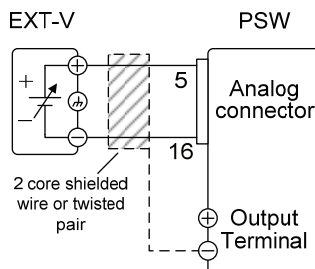

- Pin16 → EXT-V (-)
- Pin5 → EXT-V (+)
- Wire shield → negative (-) output terminal

**Connection- alt. shielding**

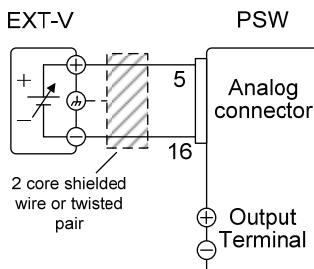

If the wire shield needs to be grounded at the voltage source (EXT-V), then the shield cannot also be grounded at the negative (-) terminal output of the PSW power supply. This would short the output.



- Pin16 → EXT-V (-)
- Pin5 → EXT-V (+)
- Wire shield → EXT-V ground (GND)

**Panel operation**

1. Connect the external voltage according to the connection diagrams above.

- Page 86
2. Set the F-91 power on configuration setting to 1 (CC control – Ext voltage).
    - Be sure to cycle the power after the power on configuration has been set.
  3. Press the Function key and confirm the new configuration settings (F-91=1). 
  4. Press the Output key. The current can now be controlled with the External voltage. 



Note

The input impedance for external voltage control is 10kΩ.  
Use a stable voltage supply for the external voltage control.



CAUTION

Ensure the voltage polarity is correct when connecting the external voltage.

Ensure no more than 10.5 volts are input into the external voltage input.

## External Resistance Control of Voltage Output

---

Description

External resistance control of the voltage output is accomplished using the MIL-26 connector on the rear panel. A resistance of 0kΩ~10kΩ is used to control the full scale voltage of the instrument.

The output voltage (0 to full scale) can be controlled with the external resistance going up (Ext-R  $\searrow$ ) 0kΩ~10kΩ(10kΩ =  $V_{o,max}$ ) or down

(Ext-R $\downarrow$ ) 10k $\Omega$ ~0k $\Omega$ (10k $\Omega$  = 0).

For 0k $\Omega$ ~10k $\Omega$ : Output voltage = full scale voltage  $\times$  (external resistance/10)

For 10k $\Omega$ ~0k $\Omega$ : Output voltage = full scale voltage  $\times$  ([10-external resistance]/10)



Note

The Ext-R $\downarrow$  configuration is recommended for safety reasons. In the event that the cables become accidentally disconnected, the voltage output will drop to zero. Under similar circumstances using Ext-R $\uparrow$ , an unexpected high voltage would be output.

If switches are used to switch between fixed resistances, use switches that avoid creating open circuits. Use short-circuit or continuous resistance switches.

Connection

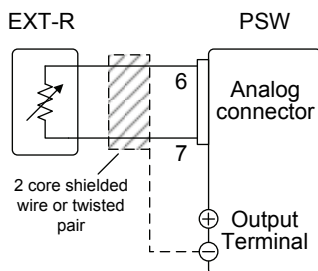



- Pin6  $\rightarrow$  EXT-R
- Pin7  $\rightarrow$  EXT-R
- Wire shield  $\rightarrow$  negative (-) output terminal

Panel operation

1. Connect the external resistance according to the connection diagrams above.
2. Set the F-90 (CV Control) configuration settings to 2 for Ext-R $\downarrow$  or 3 for Ext-R $\uparrow$ .
  - Be sure to cycle the power after the power on configuration has been set.

Page 86



3. Press the Function key and confirm the new configuration settings (F-90=2 or 3). 
4. Press the Output key. The voltage can now be controlled with the External resistance. 



Note

Ensure the resistor(s) and cables used exceed the isolation voltage of the power supply. For example: insulation tubes with a withstand voltage higher than the power supply can be used.

When choosing an external resistor ensure the resistor can withstand a high degree of heat.

## External Resistance Control of Current Output

---

### Description

External resistance control of the current output is accomplished using the MIL-26 connector on the rear panel. A resistance of  $0\text{k}\Omega\sim 10\text{k}\Omega$  is used to control the full scale current of the instrument.

The output current (0 to full scale) can be controlled with the external resistance going up (Ext-R  $\swarrow$ )  $0\text{k}\Omega\sim 10\text{k}\Omega$  ( $10\text{k}\Omega = V_{o,max}$ ) or down (Ext-R  $\searrow$ )  $10\text{k}\Omega\sim 0\text{k}\Omega$  ( $10\text{k}\Omega = 0$ ).

For  $0\text{k}\Omega\sim 10\text{k}\Omega$ : Output current = full scale current  $\times$  (external resistance/10)

For  $10\text{k}\Omega\sim 0\text{k}\Omega$ : Output current = full scale current  $\times$  ([10-external resistance]/10)

---



Note

The Ext-R $\nabla$  configuration is recommended for safety reasons. In the event that the cables become accidentally disconnected, the current output will drop to zero. Under similar circumstances using Ext-R $\sphericalangle$ , an unexpected high current would be output.

If switches are used to switch between fixed resistances, use switches that avoid creating open circuits. Use short-circuit or continuous resistance switches.

Connection

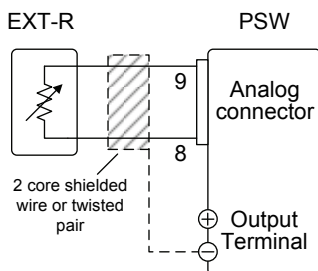

- Pin9 → EXT-R
- Pin8 → EXT-R
- Wire shield → negative (-) output terminal

Panel operation

1. Connect the external resistance according to the connection diagrams above.
  
1. Set the F-91 (CC Control) configuration settings to 2 for Ext-R $\sphericalangle$  or 3 for Ext-R $\nabla$ . Page 86
  - Be sure to cycle the power after the power on configuration has been set.
  
2. Press the Function key and confirm the new configuration settings (F-91=2 or 3). Function



3. Press the Output key. The current can now be controlled with the External resistance.

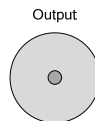

Ensure the resistor(s) and cables used exceed the isolation voltage of the power supply. For example: insulation tubes with a withstand voltage higher than the power supply can be used.

When choosing an external resistor ensure the resistor can withstand a high degree of heat.

## External Control of Output

---

### Description

The output can be turned on or off externally using a switch. The analog control connector can be set to turn the output on from a high or low signal. The voltage across pins 2 and 24 are internally pulled to +5V  $\pm 5\%$  @ 500 $\mu$ A with 10k $\Omega$  pull-up resistor. A short (closed switch) produces a low signal.

When set to High = On, the output is turned on when the pins 2-24 are open.

When Low = On, the output is turned on when pins 2-24 are shorted.

Connection

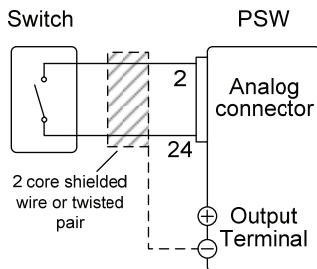

- Pin2 → Switch
- Pin24 → Switch
- Wire shield → negative (-) output terminal

Panel operation

1. Connect the external switch according to the connection diagrams above.

Set F-94 (External output logic) in Page 86 the power on configuration settings to 0 (High = On) or 1 (Low = On).

- Be sure to cycle the power after setting the power on configuration settings.

2. Press the Function key and confirm the new configuration settings.



3. The switch is now ready to set the output on or off.

 Note

When using a switch over long distances, please use a switch relay to extend the line from the coil side of the relay.

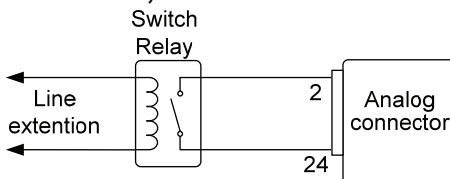

If a single switch control is to be used for multiple units, please isolate each instrument. This can be achieved by using a relay.

 Warning

Ensure the cables used and the switch exceed the isolation voltage of the power supply. For example: insulation tubes with a withstand voltage higher than the power supply can be used.

 Note

Messages: If F-94 = 0 (High = on) and the pin 24 is low (0) “MSG 001” will be displayed on the display.

If F-94 = 1 (Low = on) and the pin 24 is high (1) “MSG 002” will be displayed on the display.

Output off (High=on)

Output off (Low=on)

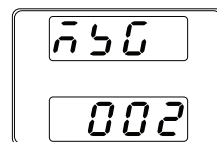
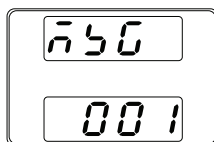

## External control of Shutdown

**Description** The output of the power supplies can be configured to shut down via an external switch. The ability to externally shut down the power supply must first be enabled in the power on configuration settings. The voltage across pins 2 and 12 are internally pulled to +5V  $\pm$ 5% @ 500uA with 10k $\Omega$  pull-up resistor.

**Connection**

- Pin2 → Switch
- Pin12 → Switch
- Wire shield → negative (-) output terminal

- Panel operation**
1. Connect the external switches according to the connection diagrams above.
  2. Set F-95 to in the configuration settings to 0 (Enable). This will allow the external control of shutdown. Page 86
  3. Press the function key and confirm the new configuration settings. Function
- 
4. The switch will now shut down the power supply when shorted.



Note

When using a switch over long distances, please use a switch relay to extend the line from the coil side of the relay.

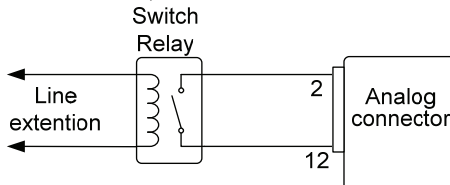

If a single switch control is to be used for multiple units, please isolate each instrument. This can be achieved by using a relay.



Warning

Ensure the cables and switch used exceed the isolation voltage of the power supply. For example: insulation tubes with a withstand voltage higher than the power supply can be used.

## Remote Monitoring

The PSW power supplies have remote monitoring support for current and voltage output. They also support monitoring of operation and alarm status.

- External monitoring of output voltage and current → from page 104
- External monitoring of operation mode and alarm status → from page 106

## External Voltage and Current Monitoring

---

### Background

The MIL 26 pin connector is used to monitor the current (IMON) or voltage (VMON) output.

An output of 0~10V represents the voltage or current output of 0~ rated current/voltage output.

- $IMON = (\text{current output} / \text{full scale}) \times 10$
- $VMON = (\text{voltage output} / \text{full scale}) \times 10$

External voltage and current monitoring doesn't need to be enabled in the configuration settings.

---



### VMON Connection

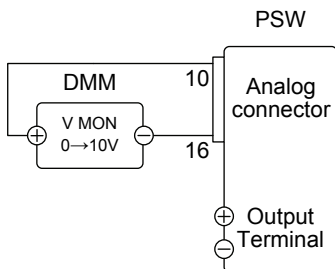

- Pin16 → Neg (-)
- Pin10 → Pos (+)

### IMON Connection

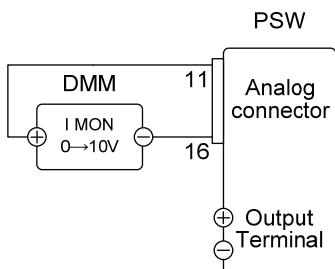

- Pin16 → Neg (-)
- Pin11 → Pos (+)



Note

The output impedance of the voltage (VMON) and current (IMON) monitor pins is 1k $\Omega$ .

Maximum current is 10mA.

The monitor outputs are strictly DC and should not be used to monitor analog components such as transient voltage response or ripple etc.



CAUTION

Ensure IMON(pin 11) and VMON(pin 10) are not shorted together. This will cause damage to the unit.

## External Operation and Status Monitoring

### Background

The MIL 26 pin connector can also be used to monitor the status operation and alarm status of the instrument.

The pins are isolated from the power supply internal circuitry by photo couplers. Status Com (Pin 17) is a photo coupler emitter output, whilst pins 18~22 are photo coupler collector outputs.

A maximum of 30V and 8mA can be applied to each pin.

Name and Pin	Description
STATUS COM 17	Common (photo coupler emitter) for status signals 18, 19, 20, 21 and 22.
CV STATUS 18	Low when CV mode is active.
CC STATUS 19	Low when CC mode is active.
ALM STATUS 20	Low when any of the protection modes are tripped (OVP, OCP). Active low.
OUT ON STATUS 21	Low when the output is on.
PWR OFF STATUS 22	Active low.

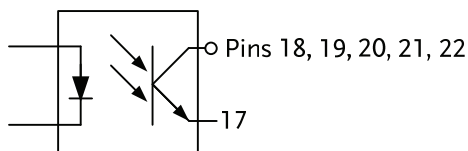

# C

# COMMUNICATION

# INTERFACE

This chapter describes basic configuration of IEEE488.2 based remote control. For a command list, refer to the programming manual, downloadable from GW Instek website, [www.gwinstek.com](http://www.gwinstek.com)

---

<b>Interface Configuration .....</b>	<b>108</b>
USB Remote Interface .....	108
Configure GPIB Interface .....	108
Configure the Ethernet Interface .....	109
USB Remote Control Function Check .....	110
Web Server Remote Control Function Check.....	111

## Interface Configuration

### USB Remote Interface

USB configuration	PC side connector	Type A, host
	PSW side connector	Rear panel Type B, slave
	Speed	1.1/2.0 (full speed/high speed)
	USB Class	CDC (communications device class)

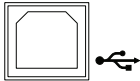
- Panel operation
1. Connect the USB cable to the rear panel USB B port. 
  2. Change the Rear panel-USB (F-22) Page 84 setting to USB-CDC (2).

### Configure GPIB Interface

To use GPIB, the optional GPIB to USB (GUG-001) adapter must be used. Only one GPIB address can be used at a time.

- Configure GPIB
1. Ensure the PSW is off before proceeding.
  2. Connect the USB cable from the rear panel USB B port on the PSW to the USB A port on the GPIB to USB adapter.
  3. Connect a GPIB cable from a GPIB controller to the GPIB port on the adapter.

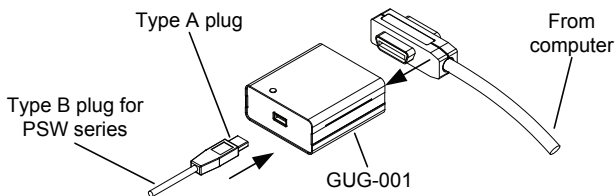

4. Turn the PSW on.
5. Press the Function key to enter the Page 84 Normal configuration settings.

Set the following GPIB settings

- |             |   |
|-------------|---|
| F-22 = 1    | Set the rear panel USB port to GPIB-USB (GUG-001) |
| F-23 = 0~30 | Set the GPIB address (0~30)                       |

- GPIB constraints
- Maximum 15 devices altogether, 20m cable length, 2m between each device
  - Unique address assigned to each device
  - At least 2/3 of the devices turned On
  - No loop or parallel connection

### Configure the Ethernet Interface

The Ethernet interface can be configured for a number of different applications. Ethernet can be configured for basic remote control or monitoring using a web server or a telnet connection.

The PSW series supports DHCP connections so the instrument can be automatically connected to an existing network. Alternatively, network settings can also be manually configured.

Background	The Ethernet interface is used for remote control and monitoring over a network.	
------------	--	--

Ethernet configuration	MAC Address (display only)	LAN
------------------------	----------------------------	-----

Settings	DHCP	IP Address
	Subnet Mask	Gateway
	DNS Address	Sockets Active
	Web Server Active	Web Password Active
	Web set password	0000~9999 (default 0000)

Connection      Connect an Ethernet cable from the network to the rear panel Ethernet port.

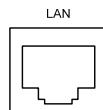

DHCP Connection Example      Use the Following configuration settings to use Dynamic Host Configuration Protocol. The following settings will also automatically assign an IP address.

6. Press the Function key to enter the Normal configuration settings. Page 84

Set the following LAN settings:

- |          |                        |
|----------|------------------------|
| F-37 = 1 | Turn DHCP to enable    |
| F-59 = 1 | Turn the web server on |



Note

It may be necessary to cycle the power or refresh the web browser to connect to a network.

## USB Remote Control Function Check

Functionality check      Invoke a terminal application such as MTTY (Multi-Threaded TTY).

To check the COM port No, see the Device Manager in the PC. For WinXP; Control panel → System → Hardware tab.

Run this query command via the terminal after the instrument has been configured for USB

remote control (page 108).

\*idn?

This should return the Manufacturer, Model number, Serial number, and Firmware version in the following format.

GW-INSTEK,PSW-3036,TW123456,01.00.20110101

Manufacturer: GW-INSTEK

Model number : PSW-3036

Serial number : TW123456

Firmware version : 01.00.20110101

- ^j can be used as the terminal character when entering the queries/commands from a terminal application.
- 



Note

For further details, please see the programming manual, available on the GW Instek web site @ [www.gwinstek.com](http://www.gwinstek.com).

---

## Web Server Remote Control Function Check

---

Functionality  
check

Enter the IP address of the power supply in a web browser after the instrument has been configured as a web server (page 109).

`http:// XXX.XXX.XXX.XXX`

The web browser interface appears.

---



Note

For further details, please see the programming manual, available on the GW Instek web site @ [www.gwinstek.com](http://www.gwinstek.com).

# **M** AINTENANCE

The PSW power supply filters should be replaced on a periodic schedule to maintain performance and specification characteristics.

---

Replacing the Dust Filter..... 113



## Replacing the Dust Filter

The dust filter should be replaced at least 2 times a year. Not replacing the filter on a regular basis will reduce performance and may cause the unit to overheat.

Front panel filter (all models) 7. Turn the instrument off.

8. Pull the filter out from the bottom of the front panel.

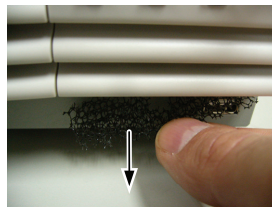

9. Replace the filter with GW Instek part number 57RG-30B00101.

Side panel filters (Type II & Type III) 1. Lift the side panel up and away from the case.

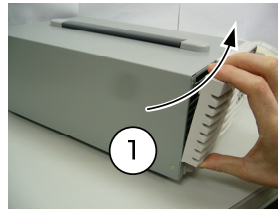

2. Remove the filter from the grill and replace with a new filter (GW Instek part number 57RG-30B00201).

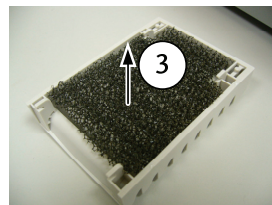

# FAQ

---

- The power supply won't let me change the mode (C.V. mode ↔ C.C. mode).
- The OVP voltage is triggered earlier than expected.
- Can I combine more than 1 cable together for the output wiring?
- The accuracy does not match the specification.

The power supply won't let me change the mode (C.V. mode ↔ C.C. mode).

---

To set the power supply to CC or CV mode, the Function key must be held when the power is turned on to enter the Power On Configuration Mode. See page 83.

The OVP voltage is triggered earlier than expected.

---

When setting the OVP voltage, take into account the voltage drop from the load cables. As the OVP level is set from the output terminals and not the load terminals, the voltage at the load terminals may be slightly lower.

Can I combine more than 1 cable together for the output wiring?

---

Yes. Cables can be used together (in parallel) if the current capacity of a single cable is insufficient. However the withstand voltage should also be taken into account. Ensure the cables are twisted together and are the same length.

The accuracy does not match the specification.

---

Make sure the device is powered On for at least 30 minutes, within +20°C~+30°C. This is necessary to stabilize the unit to match the specification.

For more information, contact your local dealer or GWInstek at [www.gwinstek.com](http://www.gwinstek.com) / [marketing@goodwill.com.tw](mailto:marketing@goodwill.com.tw).

# APPENDIX

## PSW Default Settings

The following default settings are the factory configuration settings for the power supply (Function settings/Test settings).

Normal Function Settings		
Settings	Setting	Default Setting
Output ON delay time	F-01	0.00s
Output OFF delay time	F-02	0.00s
V-I mode slew rate select	F-03	0 = CV high speed priority
Rising voltage slew rate	F-04	60.00V/s (PSW 30-XX) 160.0V/s (PSW 80-XX)
Falling voltage slew rate	F-05	60.00V/s (PSW 30-XX) 160.0V/s (PSW 80-XX)
Rising current slew rate	F-06	72.00A/s (PSW 30-36) 144.0A/s (PSW 30-72) 216.0A/s (PSW 30-108) 27.00A/s (PSW 80-13.5) 54.00A/s (PSW 80-27) 81.00A/s (PSW 80-40.5)
Falling current slew rate	F-07	72.00A/s (PSW 30-36) 144.0A/s (PSW 30-72) 216.0A/s (PSW 30-108) 27.00A/s (PSW 80-13.5) 54.00A/s (PSW 80-27) 81.00A/s (PSW 80-40.5)
Internal resistance setting	F-08	0.000Ω
Bleeder circuit control	F-09	1 = ON
Buzzer ON/OFF control	F-10	0 = ON
USB/GPIB setting		
Front panel USB State	F-20	0 = Absent

Rear panel USB State	F-21	0 = Absent
Rear Panel USB Mode	F-22	2 = USB CDC
GPIB address	F-23	8
<b>LAN setting</b>		
MAC Address-1	F-30	0x00~0xFF
MAC Address-2	F-31	0x00~0xFF
MAC Address-3	F-32	0x00~0xFF
MAC Address-4	F-33	0x00~0xFF
MAC Address-5	F-34	0x00~0xFF
MAC Address-6	F-35	0x00~0xFF
LAN	F-36	1 = Enable
DHCP	F-37	1 = Enable
IP Address-1	F-39	0
IP Address-2	F-40	0
IP Address-3	F-41	0
IP Address-4	F-42	0
Subnet Mask-1	F-43	0
Subnet Mask-2	F-44	0
Subnet Mask-3	F-45	0
Subnet Mask-4	F-46	0
Gateway-1	F-47	0
Gateway-2	F-48	0
Gateway-3	F-49	0
Gateway-4	F-50	0
DNS address -1	F-51	0
DNS address -2	F-52	0
DNS address-3	F-53	0
DNS address-4	F-54	0
Sockets active	F-57	1 = Enable
Web Server active	F-59	1 = Enable
Web password active	F-60	1 = Enable
Web setting password	F-61	0000
<b>Power On Configuration</b>		
CV Control	F-90	0= Panel control (local)
CC Control	F-91	0= Panel control (local)
Power-ON Output	F-92	0 = OFF at startup
Master/Slave	F-93	0 = Master/Local
External Out Logic	F-94	0= High ON
Power Switch trip	F-95	1 = Disable
<b>Calibration</b>		
Calibration	F-00	0000

Test Setting		
Test Run	T-01	1
Test Load	T-02	1
Test Export	T-03	1
Test Remove	T-04	1

## Error Messages & Messages

The following error messages or messages may appear on the PSW screen during operation.

Error Messages	Description
Err 001	USB Mass Storage is not present
Err 002	No (such)file in USB mass storage
Err 003	Empty memory location

Messages	Description
MSG 001	External control of output. Output off (F-94=0, High=on)
MSG 002	External control of output. Output off (F-94=1, Low=on)
MSG 003	No connection. (F-93=1 or F-93=2)

## LCD Display Format

Use the following table to read the LCD display messages.

0	1	2	3	4	5	6	7	8	9	A	B	C	D
0	1	2	3	4	5	6	7	8	9	A	b	C	d
E	F	G	H	I	J	K	L	M	N	O	P	Q	R
E	F	G	H	I	J	K	L	M	N	O	P	Q	R
S	T	U	V	W	X	Y	Z	( )	+	-	,		
S	T	U	V	W	X	Y	Z	( )	+	-	,		

## PSW Specifications

The specifications apply when the PSW is powered on for at least 30 minutes.

### PSW 30-36, PSW 80-13.5

Model		PSW 30-36	PSW 80-13.5
DC Output Ratings:	Voltage	30V	80V
	Current	36A	13.5A
	Power	360W	360W
Load Effect:	Voltage	0.05% of rating + 5mV	0.05% of rating + 5mV
	Current	0.1% of rating + 5mA	0.1% of rating + 5mA
Source Effect: (change from 85-132 VAC input or 170-265 VAC input)			
	Voltage	0.05% of rating + 3mV	0.05% of rating + 3mV
	Current	0.1% of rating + 5mA	0.1% of rating + 5mA
Output Ripple and Noise: (Noise Bandwidth=20MHz, Ripple Bandwidth=1MHz)			
	CV p-p	60mV	60mV
	CV rms	7mV	7mV
	CC rms	72mA	27mA
Programming accuracy	Voltage	0.05% + 10mV	0.05% + 10mV
	Current	0.1% + 30mA	0.1% + 10mA
Measurement accuracy	Voltage	0.1% + 10mV	0.1% + 10mV
	Current	0.1% + 30mA	0.1% + 10mA
Load Transient Recovery Time: (time for output voltage to recover within 0.1% + 10mV of its rated output for a load change from 50 to 100% of its rated output current)			
	Time	1ms	
Output Response Time:			
	Rise time	50ms	
	Fall time, full load	50ms	
	Fall time, no load	500ms	
Programming/ Measurement Resolution:	Voltage	1mV (by PC remote control mode)	2mV (by PC remote control mode)
	Current	1mA (by PC remote control mode)	1mA (by PC remote control mode)
Series and Parallel Capability			
	Parallel operation	Up to 3 units including the master unit	
	Series operation	Up to 2 units including the master unit	





---

AC Input: Input	Nominal Input	100 - 240 VAC; 50/60Hz	
	Input Range	85VAC ~ 265VAC	
	Frequency	47Hz ~ 63Hz	
	Hold up Time	> 20ms (at rated load)	
	Input Current	5A@100VAC / 2.5A@200VAC	
	Power (max)	500VA	
	Power Factor (typ)	0.98	
	Efficiency (typ)	75%	78%
	Inrush Current	< 15Apeak	
	General	Weight	Approx. 3kg
Dimensions		WxHxD = 71x124x350 mm	

**PSW 30-72, PSW 80-27**

Model		PSW 30-72	PSW 80-27
DC Output Ratings:	Voltage	30V	80V
	Current	72A	27A
	Power	720W	720W
Load Effect:	Voltage	0.05% of rating + 5mV	0.05% of rating + 5mV
	Current	0.1% of rating + 5mA	0.1% of rating + 5mA
Source Effect: (change from 85-132 VAC input or 170-265 VAC input)			
	Voltage	0.05% of rating + 3mV	0.05% of rating + 3mV
	Current	0.1% of rating + 5mA	0.1% of rating + 5mA
Output Ripple and Noise: (Noise Bandwidth=20MHz, Ripple Bandwidth=1MHz)			
	CV p-p	80mV	80mV
	CV rms	11mV	11mV
	CC rms	144mA	54mA
Programming accuracy	Voltage	0.1% + 10mV	0.1% + 10mV
	Current	0.1% + 60mA	0.1% + 30mA
Measurement accuracy	Voltage	0.1% + 10mV	0.1% + 10mV
	Current	0.1% + 60mA	0.1% + 30mA
Load Transient Recovery Time: (time for output voltage to recover within 0.1% + 10mV of its rated output for a load change from 50 to 100% of its rated output current)			
	Time	1ms	
Output Response Time:			
	Rise time	50ms	
	Fall time, full load	50ms	
	Fall time, no load	500ms	
Programming/ Measurement Resolution:	Voltage	1mV (by PC remote control mode)	2mV (by PC remote control mode)
	Current	2mA (by PC remote control mode)	2mA (by PC remote control mode)
Series and Parallel Capability			
	Parallel operation	Up to 3 units including the master unit	
	Series operation	Up to 2 units including the master unit	
Temperature Coefficient: (after a 30 minute warm-up)			
	Voltage	100ppm/°C	
	Current	200ppm/°C	
Temperature Drift: (over 8 hours, after a 30 minute warm-up, with constant line, load, and temperature)			

	Voltage (0.05% of rated Vo)	15mV	40mV
	Current (0.05% of rated Io)	36mA	13.5mA
Protection Function	OVP setting range	10% to 110% of rated output voltage	
	OVP accuracy	1%	
	OCP setting range	10% to 110% of rated output current	
	OCP accuracy	1%	
	OTP	Activated by elevated internal temperatures	
Analog Programming and monitoring			
	EXT-V Control Vo	Accuracy & linearity = +/-0.5% of rated Vout	
	EXT-V Control Io	Accuracy & linearity = +/-1% of rated Iout	
	EXT-R Control Vo	Accuracy & linearity = +/-1.5% of rated Vout	
	EXT-R Control Io	Accuracy & linearity = +/-1.5% of rated Iout	
	Vo Monitor	Accuracy = 1%	
	Io Monitor	Accuracy = 1%	
Front Panel Display Accuracy: 4 digits			
	Voltage	0.1% ± 2 count	0.1% ± 2 count
	Current	0.1% ± 7 count	0.1% ± 4 count
Environmental Conditions:	Operating temp.	0° C to 50° C	
	Storage temp.	-25° C to 70° C	
	Operating humidity	20% to 85% RH	
	Storage humidity	90% RH or less	
Interface	USB	TypeA: Host, TypeB: Slave, Speed: 1.1/2.0, USB Class: CDC(Communications Device Class)	
	LAN	MAC Address, DNS IP Address, User Password, Gateway IP Address, Instrument IP Address, Subnet Mask	
	GPIB	Optional: GUG-001 (GPIB to USB Adapter)	
AC Input:	Nominal Input	100 - 240 VAC; 50/60Hz	
	Input Range	85VAC ~ 265VAC	
	Frequency	47Hz ~ 63Hz	
	Hold up Time	> 20ms (at rated load)	
	Input Current	10A@100VAC / 5A@200VAC	



## PSW 30-108, PSW 80-40.5

Model		PSW 30-108	PSW 80-40.5
DC Output Ratings:	Voltage	30V	80V
	Current	108A	40.5A
	Power	1080W	1080W
Load Effect:	Voltage	0.05% of rating + 5mV	0.05% of rating + 5mV
	Current	0.1% of rating + 5mA	0.1% of rating + 5mA
Source Effect: (change from 85-132 VAC input or 170-265 VAC input)			
	Voltage	0.05% of rating + 3mV	0.05% of rating + 3mV
	Current	0.1% of rating + 5mA	0.1% of rating + 5mA
Output Ripple and Noise: (Noise Bandwidth=20MHz, Ripple Bandwidth=1MHz)			
	CV p-p	100mV	100mV
	CV rms	14mV	14mV
	CC rms	216mA	81mA
Programming accuracy	Voltage	0.1% + 10mV	0.1% + 10mV
	Current	0.1% + 100mA	0.1% + 40mA
Measurement accuracy	Voltage	0.1% + 10mV	0.1% + 10mV
	Current	0.1% + 100mA	0.1% + 40mA
Load Transient Recovery Time: (time for output voltage to recover within 0.1% + 10mV of its rated output for a load change from 50 to 100% of its rated output current)			
	Time	1ms	
Output Response Time:			
	Rise time	50ms	
	Fall time, full load	50ms	
	Fall time, no load	500ms	
Programming/ Measurement Resolution:	Voltage	1mV (by PC remote control mode)	2mV (by PC remote control mode)
	Current	3mA (by PC remote control mode)	3mA (by PC remote control mode)
Series and Parallel Capability			
	Parallel operation	Up to 3 units including the master unit	
	Series operation	Up to 2 units including the master unit	
Temperature Coefficient: (after a 30 minute warm-up)			
	Voltage	100ppm/°C	
	Current	200ppm/°C	
Temperature Drift: (over 8 hours, after a 30 minute warm-up, with constant line, load, and temperature)			

	Voltage (0.05% of rated Vo)	15mV	40mV
	Current (0.05% of rated Io)	54mA	20.25mA
Protection Function	OVP setting	10% to 110% of rated output voltage range	
	OVP accuracy	1%	
	OCP setting	10% to 110% of rated output current range	
	OCP accuracy	1%	
	OTP	Activated by elevated internal temperatures	
Analog Programming and Monitoring			
	EXT-V Control Vo	Accuracy & linearity = +/-0.5% of rated Vout	
	EXT-V Control Io	Accuracy & linearity = +/-1% of rated Iout	
	EXT-R Control Vo	Accuracy & linearity = +/-1.5% of rated Vout	
	EXT-R Control Io	Accuracy & linearity = +/-1.5% of rated Iout	
	Vo Monitor	Accuracy = 1%	
	Io Monitor	Accuracy = 1%	
Front Panel Display	Accuracy: 4 digits		
	Voltage	0.1% ± 2 count	0.1% ± 2 count
	Current	0.1% ± 1 count	0.1% ± 5 count
Environmental Conditions:	Operating temp.	0 °C to 50 °C	
	Storage temp.	-25 °C to 70 °C	
	Operating humidity	20% to 85% RH	
	Storage humidity	90% RH or less	
Interface	USB	TypeA: Host, TypeB: Slave, Speed: 1.1/2.0, USB Class: CDC(Communications Device Class)	
	LAN	MAC Address, DNS IP Address, User Password, Gateway IP Address, Instrument IP Address, Subnet Mask	
	GPIB	Optional: GUG-001 ( GPIB to USB Adapter)	
AC Input:	Nominal Input	100 - 240 VAC; 50/60Hz	
	Input Range	85VAC ~ 265VAC	
	Frequency	47Hz ~ 63Hz	
	Hold up Time	> 20ms (at rated load)	
	Input Current	15A@100VAC / 7.5A@200VAC	

---

	Power (max)	1500VA
	Power Factor	0.98
	(typ)	
	Efficiency (typ)	75% 78%
	Inrush Current	< 45Apeak
General	Weight	Approx. 7kg
	Dimensions	W×H×D =214×124×350 mm

---





Type II

PSW 80-27/PSW 30-72 (mm)

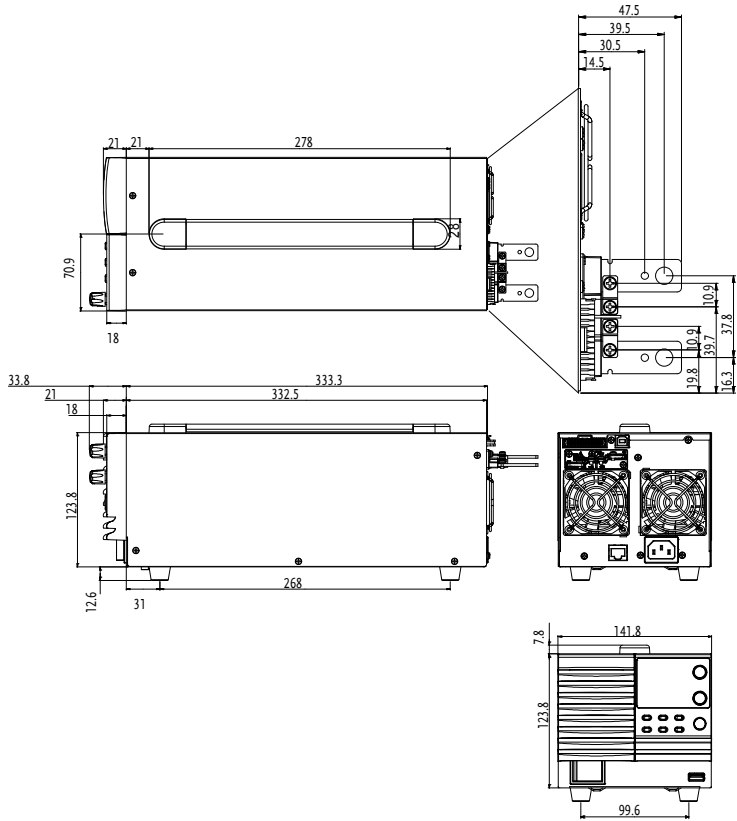

Type III

PSW 80-40.5/PSW 30-108 (mm)

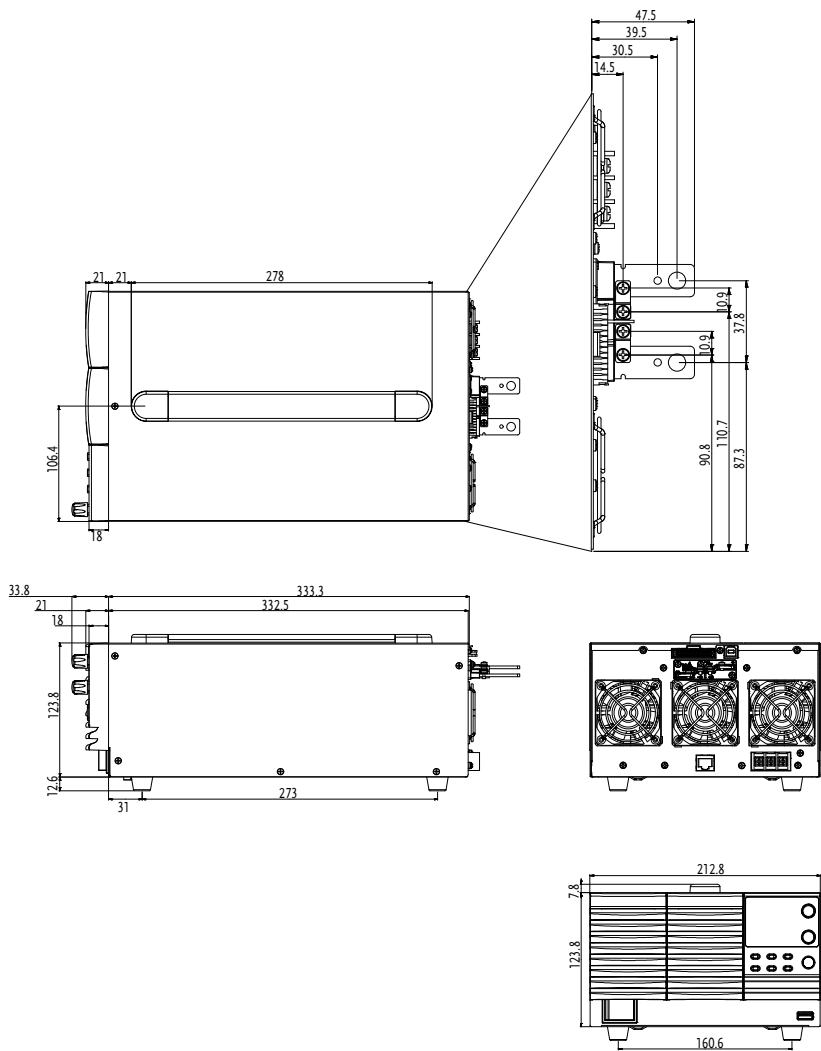

# Declaration of Conformity

We

**GOOD WILL INSTRUMENT CO., LTD.**

No. 7-1, Jhongsing Rd, Tucheng Dist., New Taipei City 236, Taiwan

**GOOD WILL INSTRUMENT (SUZHOU) CO., LTD.**

No. 69 Lushan Road, Suzhou New District Jiangsu, China.

declare that the below mentioned product

**Type of Product: Multi-Range DC Power Supply**

**Model Number:** PSW 30-36, PSW 80-13.5, PSW 30-72, PSW 80-27, PSW 30-108, PSW 80-40.5

are herewith confirmed to comply with the requirements set out in the Council Directive on the Approximation of the Law of Member States relating to Electromagnetic Compatibility (2004/108/EC) and Low Voltage Directive (2006/95/EC).

For the evaluation regarding the Electromagnetic Compatibility and Low Voltage Directive, the following standards were applied:

© EMC	
EN 61326-1: Electrical equipment for measurement, control and laboratory use -- EMC requirements (2006)	
Conducted Emission Radiated Emission CISPR11: 2003+A1: 2004+A2: 2006	Electrostatic Discharge IEC 61000-4-2: 2008
Current Harmonics EN 61000-3-2: 2006+A1:2009+A2:2009	Radiated Immunity IEC 61000-4-3: 2008
Voltage Fluctuations EN 61000-3-3: 2008	Electrical Fast Transients IEC 61000-4-4: 2004 +A1:2010
-----	Surge Immunity IEC 61000-4-5: 2005
-----	Conducted Susceptibility IEC 61000-4-6: 2008
-----	Power Frequency Magnetic Field IEC 61000-4-8: 2009
-----	Voltage Dip/ Interruption IEC 61000-4-11: 2004

Low Voltage Equipment Directive 2006/95/EC	
Safety Requirements	IEC/EN 61010-1: 2001

# INDEX

Accessories .....	11	Declaration of conformity .....	131
Alarm		Default settings .....	116
description .....	26	Dimensions	
Analog connector		diagram .....	130
pin assignment .....	89	Display format .....	118
Analog control		Display mode	
output control .....	99	operation .....	49
overview .....	88	Disposal instructions .....	7
remote monitoring .....	104	EN61010	
resistance control - current		measurement category .....	6
output .....	97	pollution degree .....	7
resistance control - voltage		Environment	
output .....	95	safety instruction .....	7
shutdown control .....	102	Error messages .....	118
status monitoring .....	106	Ethernet	
voltage control - current output	93	interface .....	109
voltage control - voltage output	91	FAQ .....	114
Bleeder control		Filter installation .....	35
Description .....	24	Front panel diagram .....	14
Caution symbol .....	5	Ground	
CC and CV mode		symbol .....	5
description .....	22	Grounding .....	29
CC mode		Internal resistance	
operation .....	47	description .....	25
Cleaning the instrument .....	7	LCD conversion .....	118
Configuration		Line voltage	
calibration settings .....	84	PSW 30-108/80-40.5 .....	33
LAN settings .....	81	List of features .....	11
Normal function settings .....	78	Load connection .....	38
normal function settings		Maintenance	
operation .....	84	replacing the filter .....	113
overview .....	75	Marketing	
power on configuration operation	86	contact .....	115
power on configuration settings	83	Messages .....	118
script test settings .....	67	Model differences .....	10
table .....	75	OCP level .....	43
test function settings .....	68	Operating area description .....	20
USB/GPIB settings .....	80	Operation considerations .....	26
Conventions .....	41	floating output .....	29
CV mode		inrush current .....	26
operation .....	45		

Pulsed loads .....	27	overview .....	61
reverse current .....	27	Service operation	
OVP level .....	43	about disassembly .....	6
Package contents .....	13	contact .....	115
Panel lock .....	50	Slew rate	
Parallel mode		description .....	24
connection .....	56	Specifications .....	119
operation .....	59	PSW 30-108 .....	125
overview .....	55	PSW 30-36 .....	119
Power on/off		PSW 30-72W .....	122
safety instruction .....	6	PSW 80-13.5 .....	119
Power up .....	36	PSW 80-27W .....	122
Rack mount		PSW 80-40.5 .....	125
description .....	41	Test script	
Rear panel diagram .....	17	Export .....	71
Remote control .....	107	Load .....	69
interface configuration .....	108	overview .....	67
Remote control function check	110	remove/delete test .....	72
Remote sense		Run .....	70
connection .....	53	UK power cord .....	8
operation .....	51	Warning symbol .....	5
Series mode		Web server function check .....	111
connection .....	62	Wire gauge chart .....	37
Operation .....	64		