

PROFESSIONAL WIRELESS INTERNET WEATHER STATION

Operation Manual

OVERVIEW

Outdoor sensor:

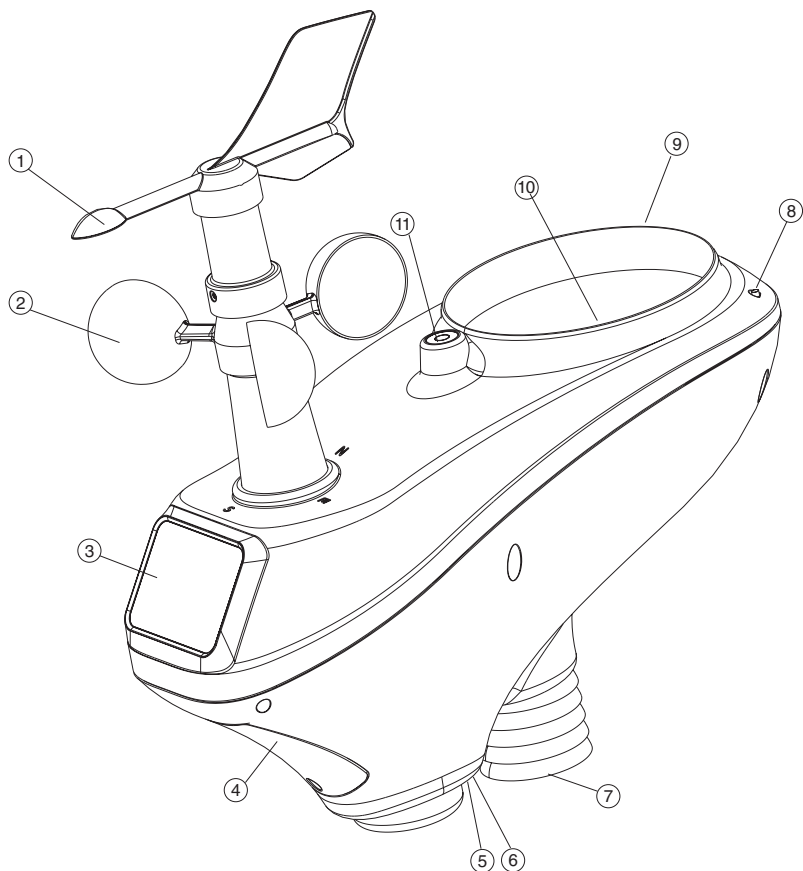

1. Wind Vane
2. Wind Speed Sensor
3. Solar panel
4. Battery compartment
5. LED Indicator: light on for 4s if the unit power up. Then the LED will flash once every 16 seconds (the sensor transmission update period).
6. Reset button
7. Thermo-hygro sensor
8. UV sensor
9. Light sensor
10. Rain collector
11. Bubble level

Indoor sensor

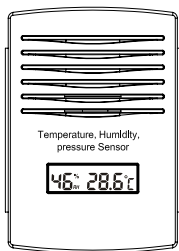

Display unit

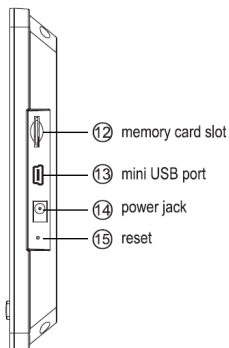
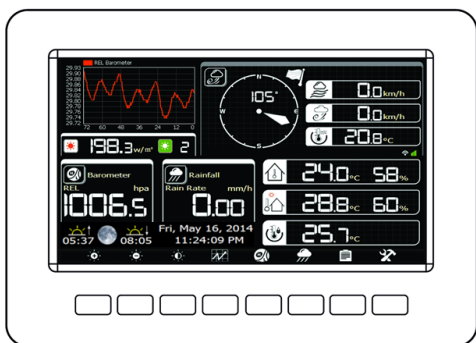

Contents

The weather station consists of the following parts.

QTY	Item
1	Display Console
1	Outdoor sensor(Thermo-hygrometer / Rain Gauge / Wind Speed Sensor /Transmitter)
1	Wind Vane
1	Indoor sensor
1	5V DC adaptor
1	Stainless Steel Tube (D32*H200mm)
1	U style Stainless Steel Loop
3	AA 1.5V rechargeable batteries for outdoor sensor
1	Zip bag for 1pc Allen wrench
1	User manual

Introduction

Thank you for your purchase this professional weather station. The outdoor sensor is solar powered and sends data to the console via a low-power radio. It allows you to upload your weather data to weather website: www.wunderground.com which you can share it with your friend.

This manual will guide you step-by-step through setting up your device. Use this manual to become familiar with your professional weather station, and save it for future reference.

Installation

Before placing and installing all components of the weather station at their final destination, please set up the weather station with all parts being nearby for testing the correct function.

Outdoor sensor

1. Attach the wind vane

Push the wind vane into the shaft, as shown in figure 1.

Tighten the set screw with the Allen Wrench (included) as shown in figure 2. Make sure the wind vane spin freely.

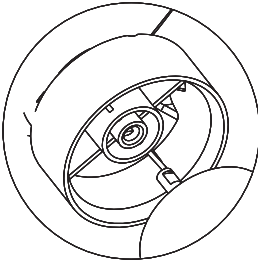

Figure 1

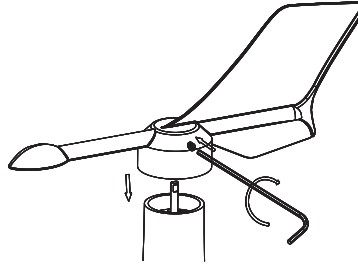

Figure 2

2. Install Mounting Pole

Insert the pole into the base, as shown in figure 3. Spin the lid onto the base as shown in figure 4.

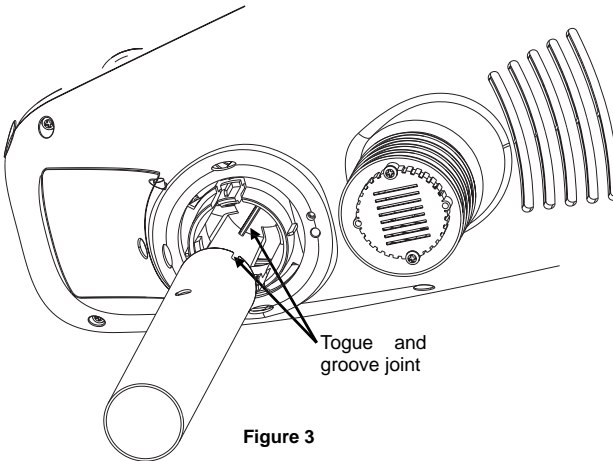

Figure 3

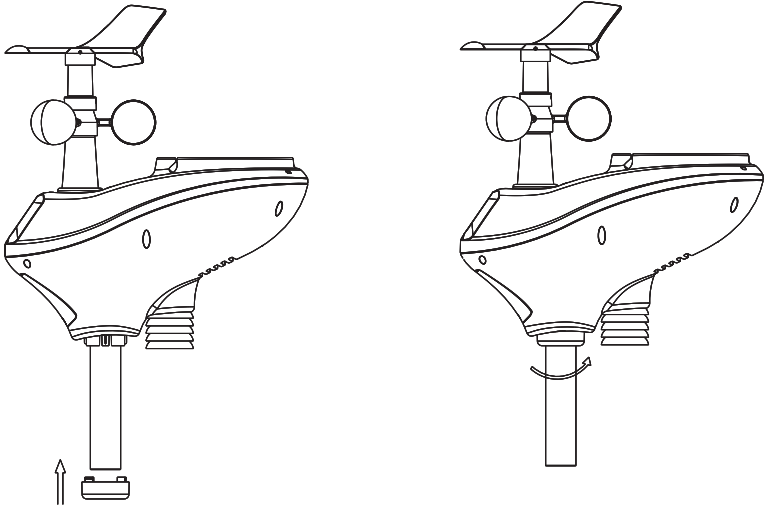

Figure 4

3. Install Batteries

Locate the battery door on the thermo-hygrometer / rain gauge transmitter, as shown in Figure 5. Turn the set screw counter clockwise to loosen the screw to open the battery compartment. Insert 3XAA rechargeable batteries in the battery compartment. The LED indicator on the back of the transmitter will turn on for four seconds and normally flash once every 16 seconds (the sensor transmission update period).

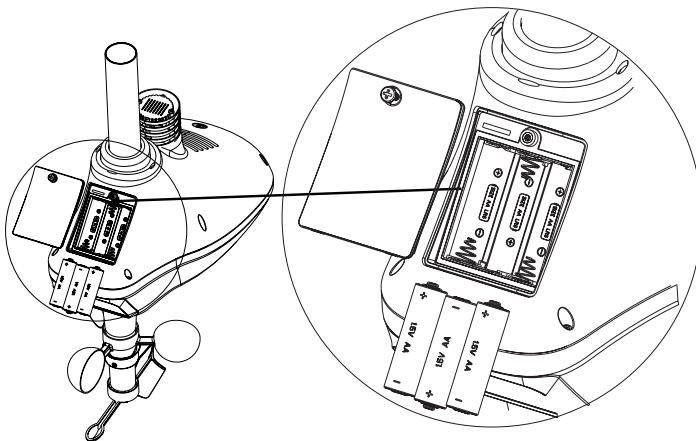

Figure 5

Note: If no LED light up or is lighted permanently, make sure the battery is inserted the correct way or a proper reset is happened. Do not install the batteries backwards. You can permanently damage the thermo-hygrometer.

4. Mount outdoor sensor

Fasten the mounting pole to your mounting pole or bracket (purchased separately) with the two U-bolts, mounting pole brackets and nuts, as shown in Figure 6.

Tighten the mounting pole to your mounting pole with the U-Bolt assembly, as shown in Figure 7..

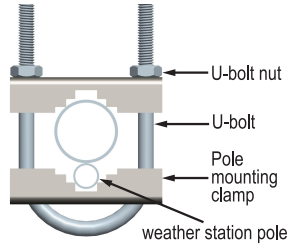

Figure 6

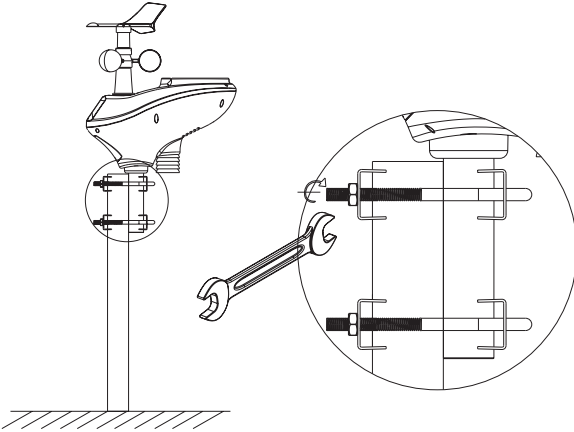

Figure 7

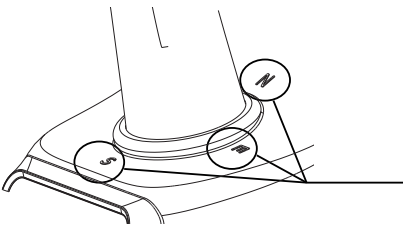

Figure 8

there are four alphabet letter of "N", "E", "S" and "W" representing for the direction of North, East, South and West, as Figure 8. Wind direction sensor has to be adjusted so that the directions on the sensor are matching with your real location. Permanent wind direction error will be introduced when the wind direction sensor is not positioned correctly during installation.

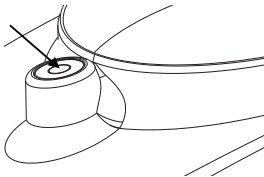

Figure 9

Level the sensors

Use the bubble level on the rain sensor as a guide to verify that sensors are level.

5. Reset Button and Transmitter LED

In the event the outdoor sensor is not transmitting, reset the outdoor sensor.

With an open ended paperclip, press and hold the **RESET BUTTON** for three seconds to completely discharge the voltage.

Take out the batteries and wait one minute, while covering the solar panel to drain the voltage.

Put batteries back in and resynchronize with console by powering down and up the console with the sensor about 10 feet away.

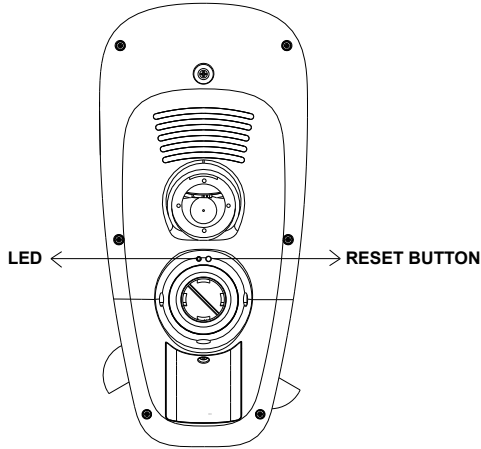

Figure 10

Indoor sensor

Remove the battery door on the back of the sensor with a Philips screwdriver (there is only one screw, at the bottom of the unit). Insert two AAA batteries as shown in Figure 10 (we recommend lithium batteries for cold weather climates, but alkaline batteries are sufficient for most climates).

Replace the battery door and set screw. Note that the temperature, humidity and pressure will be displayed on the LCD display. Looking at the back of the unit from left to right, the polarity is (-) (+) for the top battery and (+) (-) for the bottom battery.

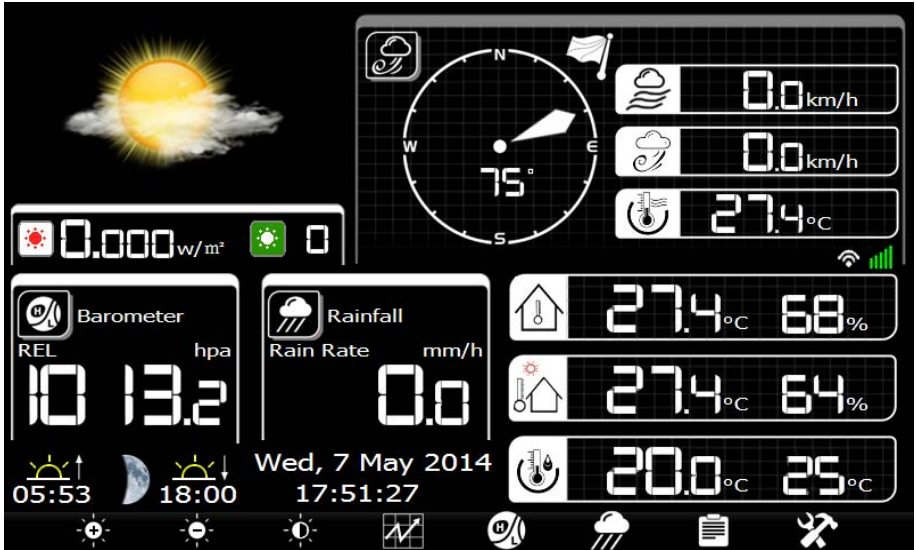



Figure 10

Initial Display Console Set Up

Connect the power adapter to power up the display console.

The display console starts to register the transmitter and receive the weather data from transmitter. The interface as below:



Then it start to scan the Wi-Fi network, if it didn't found the available Wi-Fi it will shows" not find any AP (Access Point)". Press  key to return to normal display mode. Only after connect to WLAN you can upload the data to weather website. If the data upload to server successfully, the icon  will show on beneath the wind chill.

Program Mode

1. Normal display Mode

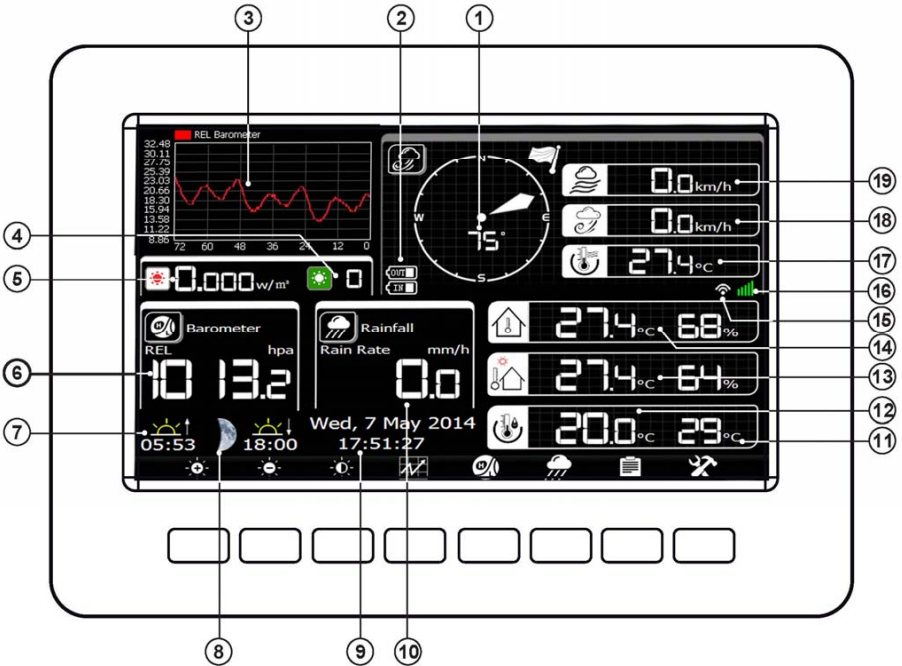







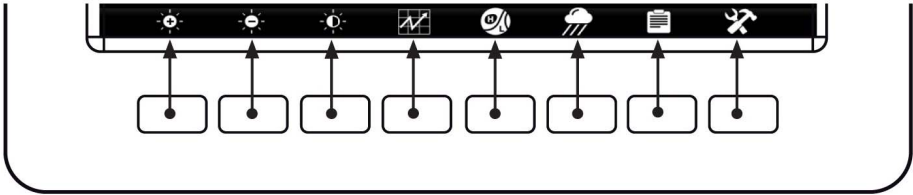

- | | |
|--|------------------------------------|
| 1. Wind direction | 10. Rainfall |
| 2. Low battery indicator | 11. Heat index |
| 3. Weather Forecast / rel. pressure graph / In & Outdoor temperature graph / In & Outdoor humidity graph | 12. Dew point |
| 4. UV index | 13. Outdoor Temperature & Humidity |
| 5. Light | 14. Indoor Temperature & Humidity |
| 6. Barometric Pressure | 15. Internet Connectivity |
| 7. sunrise/sunset | 16. WiFi Connectivity |
| 8. moon phase | 17. Wind chill |
| 9. Time and date | 18. Gust |
| | 19. Wind speed |



Note: sunrise/sunset and moon phase feature is only available in firmware Version 2.0.0 or greater.

Each icon in the display matches a black keys on plastic case. Please press the keys for operation.



Icon	Description
	Brightness control key Press this key to enhance the brightness
	Brightness control key Press this key to decrease the brightness
	Backlight on/off key Press this key to on/off the backlight
	Graph display key Press this key to choose between Weather Forecast, rel. pressure graph, in & outdoor temperature graph and in & outdoor humidity graph
	Pressure display key Press this key to choose the display between Absolute pressure and Relative pressure.
	Rain key Press this key to Shift the display between Rain Rate, Rain Day, Rain Week, Rain Month, and Rain Year.
	History key Press this key to enter History Mode
	Setting key Press this key to enter Setting Mode









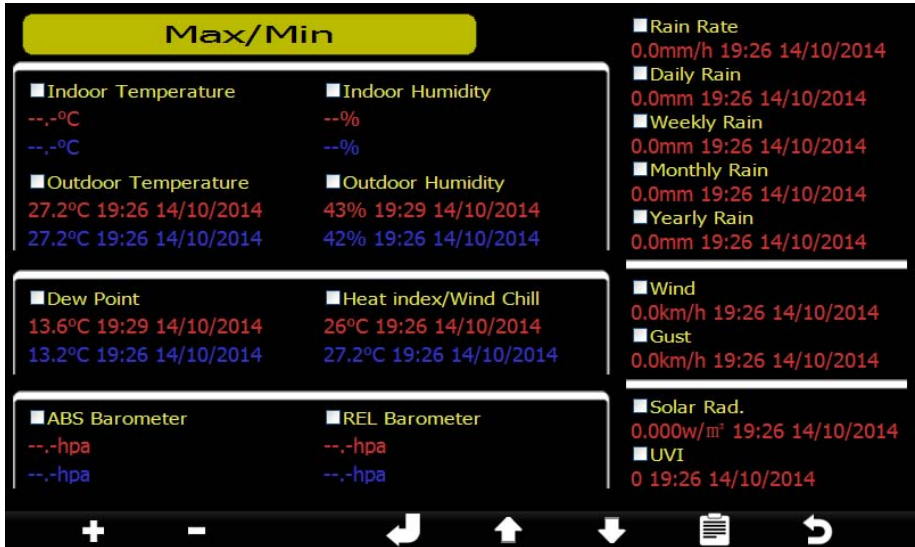

2. History Mode

While in normal display, press the  key to enter History Mode. You can select the below sub-mode by pressing the  key.

2.1 MAX/MIN Mode

While in normal display, press the  key once to enter MAX/MIN Mode.











Icon	Description
	Selection key Press this key to select the weather MAX/MIN record which need to clear
	Selection key Press this key to select the weather MAX/MIN record which need to clear
	Enter key While select the weather MAX/MIN record, press this key to popup Message Box"Are you sure to clear the Max/Min?"Press  key or  key to select YES or NO. Press the  key or  key to confirm the selection.
	Up arrow key Press this key to change the activated option field
	Down arrow key Press this key to change the activated option field
	History key Press this key to select the History sub-Mode
	Return key Press this key to return to normal display mode

2.2 History Record Mode



While in normal display, press the  key twice to enter History Record Mode.

No.	Time	Indoor Temperature (°F)	Indoor Humidity (%)	Outdoor Temperature (°F)	Outdoor Humidity (%)	Wind (mph)	Gust (mph)	Dew Point (°F)	Wind Chill (°F)	Wind Dire (°)
1	AM9:49 7/6/2012	80.2	51	80.8	49	0.0	0.0	59.9	80.8	352
2	AM9:50 7/6/2012	80.2	51	80.8	49	0.0	0.0	59.9	80.8	352
3	AM9:51 7/6/2012	80.2	51	80.6	49	0.0	0.0	59.7	80.6	352
4	AM9:52 7/6/2012	80.1	51	80.6	49	0.0	0.0	59.7	80.6	352
5	AM9:53 7/6/2012	80.1	51	80.6	49	0.0	0.0	59.7	80.6	352







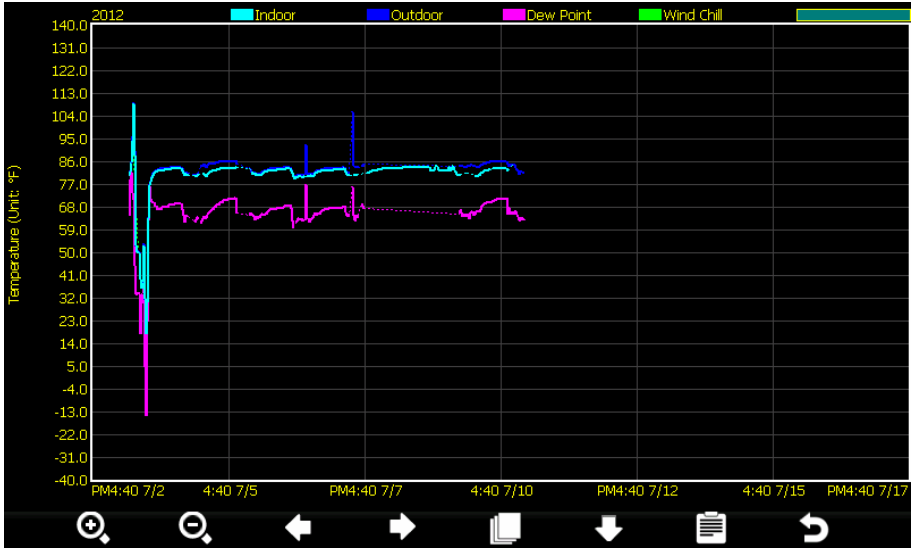

Icon	Description
	File Select key Press this key to enter the file selection mode
	Page Select key Press this key to enter the page selection mode.
	Scroll left key Press this key to view the left of the scrollable area.
	Scroll right key Press this key to view the right of the scrollable area.
	Page up key Press this key to scroll up the page you are viewing
	Page down key Press this key to scroll down the page you are viewing
	History key Press this key to select the sub-Mode
	Return key Press this key to return to previous mode

While in History Record Mode, press  key to enter the file selection mode:



2.3 History graph mode

While in normal display, press the  key twice to enter History graph Mode.









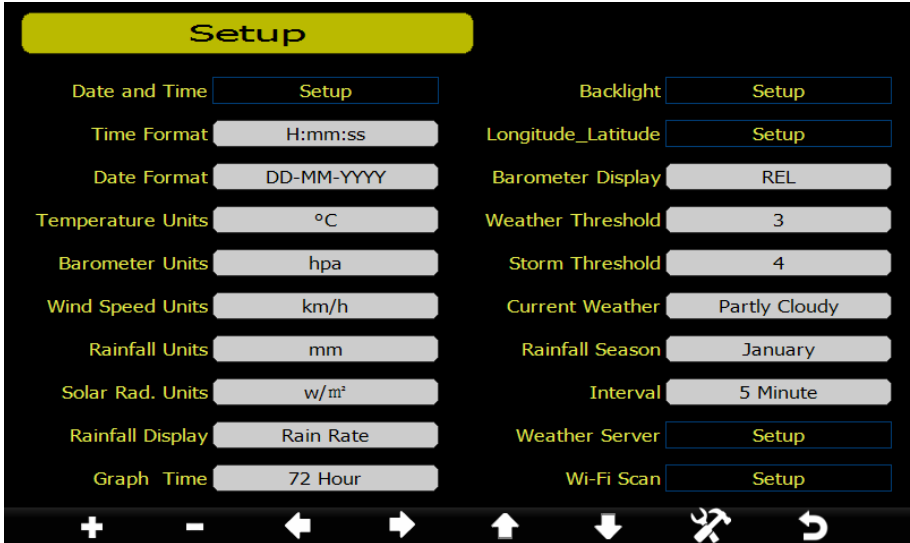

Icon	Description
	Zoom In key
	Zoom Out key
	Scroll left key Press this key to view the left of the scrollable area.
	Scroll right key Press this key to view the right of the scrollable area.
	Select file key Press this key to enter the file selection mode
	Page down key Press this key to scroll down the page you are viewing
	History key Press this key to select the sub-Mode
	Return key Press this key to return to previous mode

3. Setting Mode



While in normal display, press the  key to enter Setting Mode. You can select the below sub-mode by pressing the  key

3.1 Menu Setting Mode









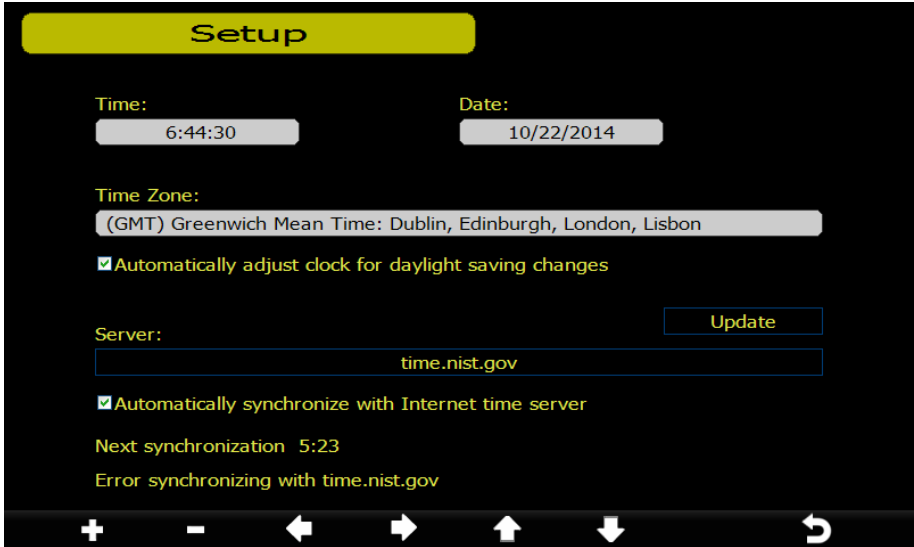





















Icon	Description
	Select key Press this key to select the unit or scrolls the value
	Select key Press this key to select the unit or scrolls the value.
	Left key Press this key to select the set value.
	Right key Press this key to select the set value.
	Up arrow key Press this key to change the activated option field
	Down arrow key Press this key to change the activated option field
	Set key Press this key to select the Setting sub-Mode
	Return key Press this key to return to previous mode

3.1.1. Date and Time setting

While in Menu Setting Mode, press  key to select Date and Time Setup field, press  or  key to enter Date and Time Setup mode:



- 1) Time setting (hour/minute/second)
Press  key to select time setting field, the hour digit turn red, press the  or  key to change the hour setting. Press  to set the minute, the minute digit turn red, press the  or  key to change the minute setting. Press  to set the second, the second digit turn red, press the  or  key to change the second setting
- 2) Date setting
Press  key to select Date setting field, the day digit turn red, press the  or  key to change the day setting. Press  to set the month, the month digit turn red, press the  or  key to change the month setting. Press  to set the year, the year digit turn red, press the  or  key to change the year setting
- 3) Time zone setting
Press  key to select Time zone setting field, press the  or  key to change the time zone setting. Press  key to select Update field, press the  or  key to update the time immediately.
- 4) DST setting
If the state that were in the Time Zone observe DST, the option of "automatically adjust clock for Daylight Saving Change" will show on beneath the Time Zone setting. Press the  or  key to select this option..
- 5) Internet time server
The default server is time.nist.gov. Press  to popup the keyboard for you to type in the new server
- 6) Automatically synchronize with an internet time server
Press the  or  key to select



- 3.1.2 Time Format setting (H:mm:ss / h:mm:ss AM / AM h:mm:ss, default H:mm:ss)
- 3.1.3 Date Format setting (MM-DD-YY, DD-MM -YY or YY- MM-DD format, default DD-MM-YYYY)
- 3.1.4 Temperature unit setting (°C / °F, default °C)
- 3.1.5 Barometric unit (hPa / inHg / mmhg, default hPa)
- 3.1.6 Wind speed unit (km/h, m/s, bft, mph, knots default: m/s)
- 3.1.7 Rainfall unit (mm, inch, default: mm)
- 3.1.8 Solar Rad. unit (lux,fc,w/m²)
- 3.1.9 Rainfall display (Rain Rate, Daily Rain, Weekly Rain , Monthly Rain, Yearly Rain)

Rain Rate: it forecast the rain per hour base on the recently 10 minute's rainfall. For example: the rainfall of recent 10 minutes is 12mm, the rain/hour is 12mm*6=72mm/h.

Note: The rain per day is reset to zero at 0:00hr every day. The rain per week is reset to zero at 0:00hr every Sunday, per month is reset to zero at 0:00hr every first day of the month. The reset of the rain per year refer to rainfall season section





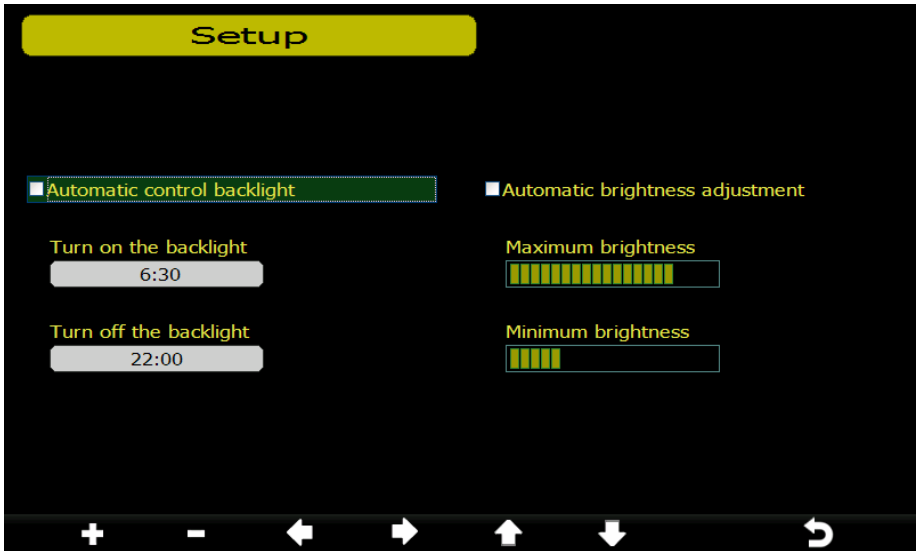

3.1.10 Graph time (12/24/48/72 hour, default 72hour)

3.1.11 Backlight setting

While in Menu Setting Mode, press  key to select Backlight Setup field, press  or  key to enter backlight Setup mode:





- Automatic control backlight: select this option, the backlight will auto turn on and off according the set time
- Turn on the backlight: set the time of turn on backlight
- Turn off the backlight: set the time of turn off backlight
- Automatic brightness adjustment: select this option, the brightness will change according to the light intensity measured from outdoor sensor
- Maximum brightness: set the maximum brightness while it is the highest light intensity
- Minimum brightness: set the minimum brightness while it is the weakest light intensity

Icon	Description
	Select key Press this key to select the unit or scrolls the value
	Select key Press this key to select the unit or scrolls the value.
	Left key Press this key to select the set value.
	Right key Press this key to select the set value.
	Up arrow key Press this key to change the activated option field
	Down arrow key Press this key to change the activated option field
	Return key Press this key to return to previous mode

If the auto backlight turn-on time has been set, you can press  key to turn off the backlight within the turn on time. Backlight will turn on again automatically at next turn on time. You can press any key to turn on the backlight for 60s within the turn off time

3.1.12 Longitude_Latitude setting

While in Menu Setting Mode, press  key to select Longitude_Latitude Setup field, press  or  key to enter Longitude_Latitude Setup mode:

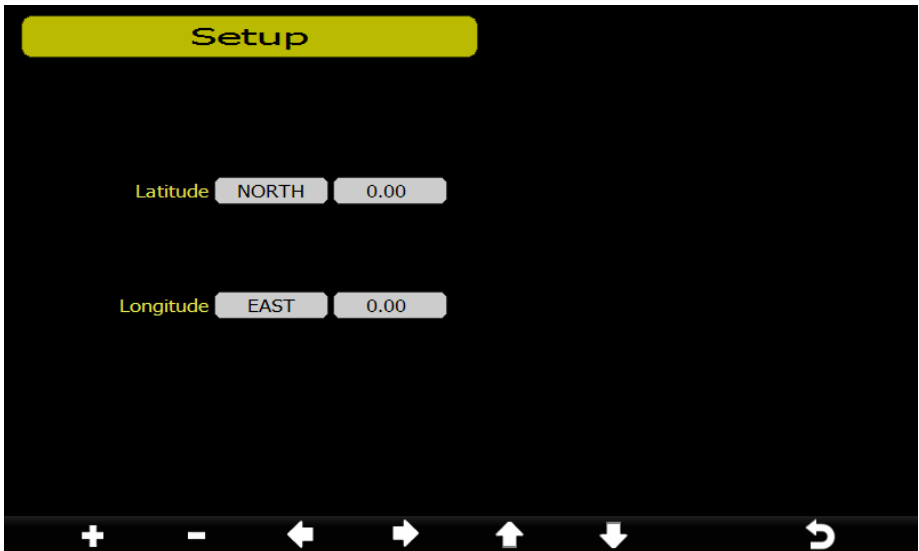

The sunrise/sunset times will be calculating automatically base on the Longitude and Latitude.

3.1.13 Barometric display (Absolutely, Relative)

3.1.14 Weather threshold (2-4, default 3)

It's pressure sensitivity setting for weather forecasting. When the pressure rises over weather threshold in past 12 hours the weather upgrades (like from partly cloudy to sunny). When the pressure drops over weather threshold in past 12 hours the weather degrades (like from cloudy to raining). For areas that experience frequent changes in air pressure requires a higher level setting compared to an area where the air pressure is stagnant. For example if 4 is selected, then there must be a fall or rise in air pressure of at least 4hPa needed to change the weather forecast icons.

3.1.15 Storm threshold (3-9, default 4)

Similar to the general pressure sensitivity setting it is possible to adjust the storm threshold sensitivity form 3-9 (default 4). When there is a fall over storm threshold within 3 hours, the storm icon will appear.

3.1.16 Current weather

The five weather icons are Sunny, Partly Cloudy, Cloudy, Rainy and Storm.



3.1.17 Rainfall season (default: January)

Rainfall season influence the annual rainfall maximum, minimum and total value. When one month was selected, the annual rainfall and annual max/min rainfall were zero clearing at 0:00 of the first day of the selected month,

3.1.18 Storing Interval (1-240minutes)







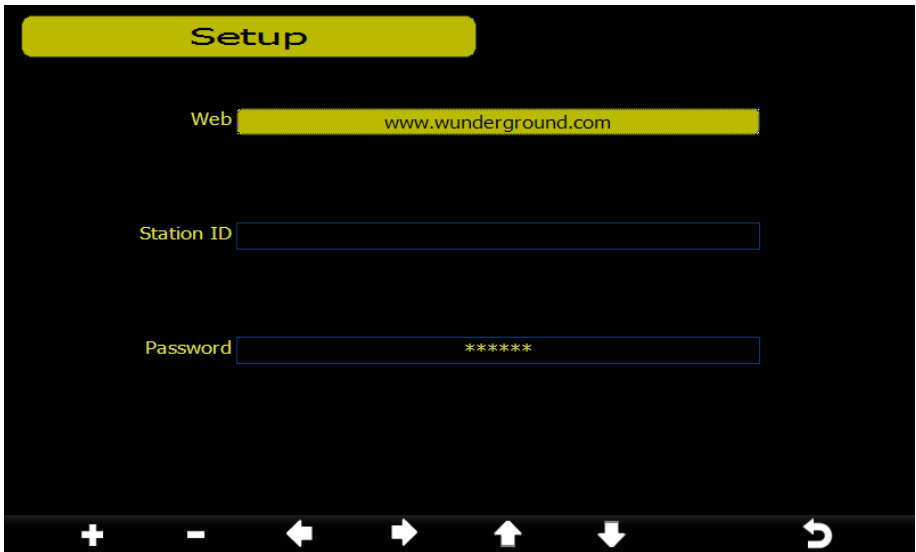









3.1.19 Weather Server

Press **+** or **-** key to enter Weather Server set up mode, type in the Station ID and password to upload the data.

The console is configured to send real-time data to wunderground.com® so there is no need to adjust the Server, Server type, and upload type. Enter the Station ID and Password from wunderground.com®. Enter your Station ID and password obtained from wunderground.com®.



+	-	↑	↓	↺
scroll value up	scroll value down	Scroll field up	Scroll field down	return to Setup

- 1) **Set Station ID.** Press  to highlight the Station ID. Enter your station ID obtained from Wunderground.com. Press  to display the keyboard. Press     to scroll to the character and press  to select the character. Press  to return to the Wunderground.com setup page.
- 2) **Set Password.** Press  to highlight the Password. Enter your password obtained from Wunderground.com. Press  to display the keyboard. Press     to scroll to the character and press  to select the character. Press  to return to the Wunderground.com setup page.

 **Note: How to create a Wunderground.com® account and station ID.**

1. Join the Wunderground.com® Community. Visit:

<https://www.wunderground.com/@members/signup.asp>

and sign up with Wunderground.com.

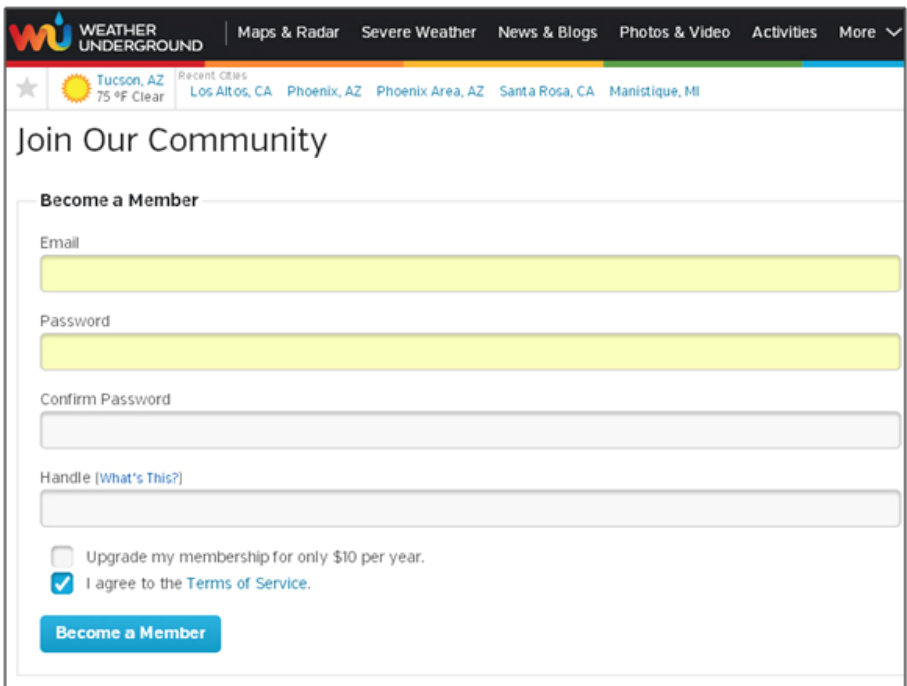

2. **Join the Personal Weather Station (PWS) network.** Visit:

<http://www.wunderground.com/personal-weather-station/signup>

or select **More | Register Your PWS** from the menu at the top of the WeatherUnderground.com website:

Personal Weather Station Network

[Overview](#) |
 [What is a PWS?](#) |
 [Buying Guide](#) |
 [Installation Guide](#) |
 [Register with WU](#)

Register a New Personal Weather Station



Enter nearest street address, then move the map to set location for your Personal Weather Station.

Map Satellite

Latitude: 0.000000

Longitude: 0.000000

Elevation (ft):

Height Above Ground (ft):

Enter the Station ID obtained and password you entered into the ObserverIP Weather Server panel.

Note: If Wunderground.com is not updating, make sure the Station ID and Password are correct. The Station ID is all capital letters, and the password is case sensitive. The most common issue is substituting an O for 0 in the Station ID.







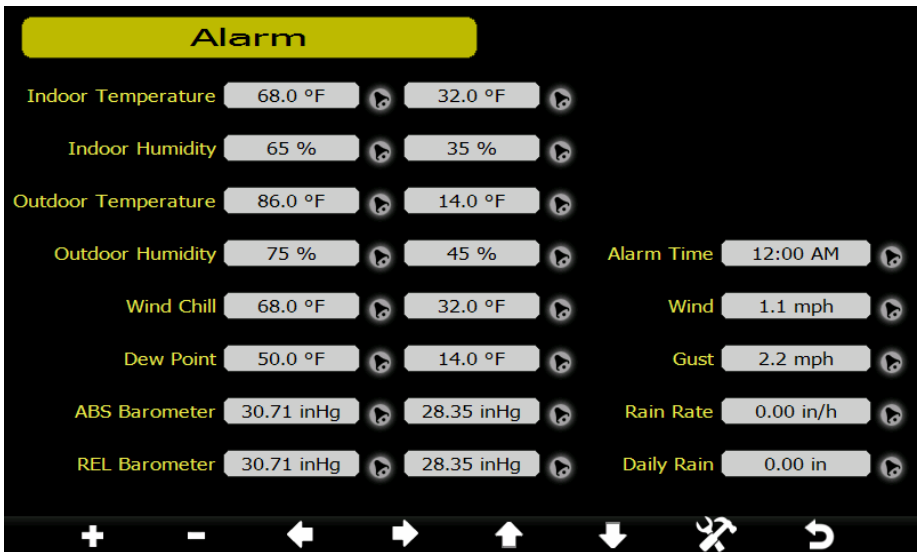

3.1.20 Wi-Fi scan



Press or key to select the Wi-Fi network. Press key to confirm and enter the password. Press key to return to normal display mode. Only after connect to WLAN you can upload the data to weather website. If the data upload to server successfully, the icon will show on beneath the wind chill.

3.2 Alarm Setting Mode









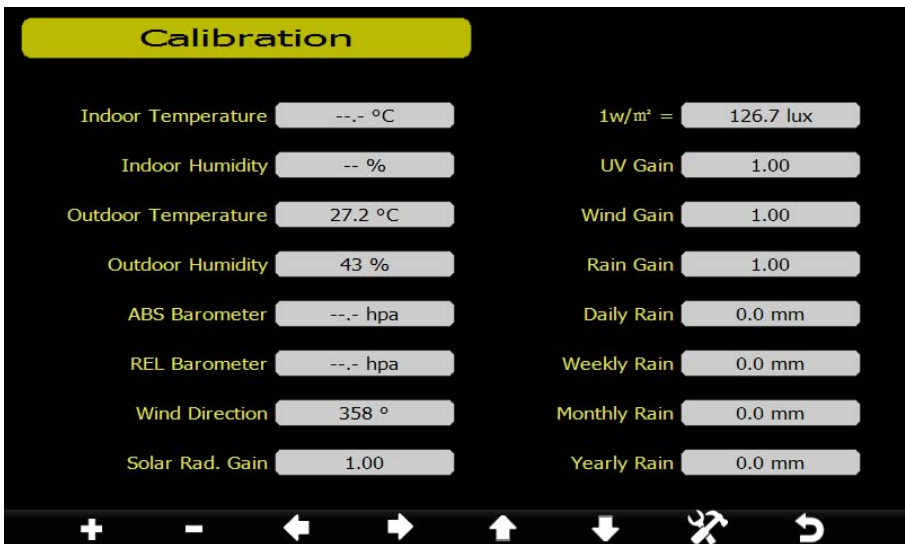

Icon	Description
	Select key Press this key to select the unit or scrolls the value
	Select key Press this key to select the unit or scrolls the value.
	Left key Press this key to select the set value.
	Right key Press this key to select the set value.
	Up arrow key Press this key to change the activated option field
	Down arrow key Press this key to change the activated option field
	Set key Press this key to select the Setting sub-Mode
	Return key Press this key to return to previous mode





The first row is high alarm value and the second row is low alarm value.

When a set weather alarm condition has been triggered, that particular alarm will sound for 120 second and the corresponding icon will flash until the weather condition doesn't meet the user set level. Press any key to mute the alarm.

3.3 Calibration Mode



Icon	Description
	Select key Press this key to select the unit or scrolls the value
	Select key Press this key to select the unit or scrolls the value.
	Left key Press this key to select the set value.
	Right key Press this key to select the set value.
	Up arrow key Press this key to change the activated option field
	Down arrow key Press this key to change the activated option field
	Set key Press this key to select the Setting sub-Mode
	Return key Press this key to return to previous mode

To adjust the parameter, press  to scroll to the parameter you wish to change. Press  to highlight the sign (positive vs. negative, if applicable) and significant digit. Press  or  to change the calibrated value.

Parameter	Type of Calibration	Default	Typical Calibration Source
Temperature	Offset	Current Value	Red Spirit or Mercury Thermometer (1)
Humidity	Offset	Current Value	Sling Psychrometer (2)
ABS Barometer	Offset	Current Value	Calibrated laboratory grade barometer
REL Barometer	Offset	Current Value	Local airport (3)
Wind Direction	Offset	Current Value	GPS, Compass (4)
Solar Radiation	Gain	1.00	Calibrated laboratory grade solar radiation sensor
1 w/m ²	Gain	126.7 lux	Solar radiation conversion from lux to w/m ² for wavelength correction (5)
Wind	Gain	1.00	Calibrated laboratory grade wind meter (6)
Rain	Gain	1.00	Sight glass rain gauge with an aperture of at least 4" (7)
Daily Rain	Offset	Current Value	Apply an offset if the weather station was not operating for the entire day.
Weekly Rain	Offset	Current Value	Apply an offset if the weather station was not operating for the entire week.
Monthly Rain	Offset	Current Value	Apply an offset if the weather station was not operating for the entire month.
Yearly Rain	Offset	Current Value	Apply an offset if the weather station was not operating for the entire year.

(1) Temperature errors can occur when a sensor is placed too close to a heat source (such as a building structure, the ground or trees).

To calibrate temperature, we recommend a mercury or red spirit (fluid) thermometer. Bi-metal (dial) and digital thermometers (from other weather stations) are not a good source and have their own margin of error. Using a local weather station in your area is also a poor source due to changes in location, timing (airport weather stations are only updated once per hour) and possible calibration errors (many official weather stations are not properly installed and calibrated).

Place the sensor in a shaded, controlled environment next to the fluid thermometer, and allow the sensor to stabilize for 48 hours. Compare this temperature to the fluid thermometer and adjust the console to match the fluid thermometer.

- (2) Humidity is a difficult parameter to measure electronically and drifts over time due to contamination. In addition, location has an adverse affect on humidity readings (installation over dirt vs. lawn for example).

Official stations recalibrate or replace humidity sensors on a yearly basis. Due to manufacturing tolerances, the humidity is accurate to $\pm 5\%$. To improve this accuracy, the indoor and outdoor humidity can be calibrated using an accurate source, such as a sling psychrometer.

- (3) The display console displays two different pressures: absolute (measured) and relative (corrected to sea-level).

To compare pressure conditions from one location to another, meteorologists correct pressure to sea-level conditions. Because the air pressure decreases as you rise in altitude, the sea-level corrected pressure (the pressure your location would be at if located at sea-level) is generally higher than your measured pressure.

Thus, your absolute pressure may read 28.62 inHg (969 mb) at an altitude of 1000 feet (305 m), but the relative pressure is 30.00 inHg (1016 mb).

The standard sea-level pressure is 29.92 in Hg (1013 mb). This is the average sea-level pressure around the world. Relative pressure measurements greater than 29.92 inHg (1013 mb) are considered high pressure and relative pressure measurements less than 29.92 inHg are considered low pressure.

To determine the relative pressure for your location, locate an official reporting station near you (the internet is the best source for real time barometer conditions, such as Weather.com or Wunderground.com), and set your weather station to match the official reporting station.

- (4) Only use this if you improperly installed the weather station sensor array, and did not point the direction reference to true north.
- (5) The default conversion factor based on the wavelength for bright sunlight is 126.7 lux / w/m². This variable can be adjusted by photovoltaic experts based on the light wavelength of interest, but for most weather station owners, is accurate for typical applications, such as calculating evapotranspiration and solar panel efficiency.
- (6) Wind speed is the most sensitive to installation constraints. The rule of thumb for properly installing a wind speed sensor is 4 x the distance of the tallest obstruction. For example, if your house is 20' tall and you mount the sensor on a 5' pole:

$$\text{Distance} = 4 \times (20 - 5)' = 60'.$$

Many installations are not perfect and installing the weather station on a roof can be difficult. Thus, you can calibrate for this error with a wind speed multiplier.

In addition to the installation challenges, wind cup bearings (moving parts) wear over time.

Without a calibrated source, wind speed can be difficult to measure. We recommend using a calibrated wind meter (available from Ambient Weather) and a constant speed, high speed fan.

- (7) The rain collector is calibrated at the factory based on the funnel diameter. The bucket tips every 0.01" of rain (referred to as resolution). The accumulated rainfall can be compared to a sight glass rain gauge with an aperture of at least 4".
Make sure you periodically clean the rain gauge funnel.

Note: The purpose of calibration is to fine tune or correct for any sensor error associated with the devices margin of error. Errors can occur due to electronic variation (example, the temperature sensor is a resistive thermal device or RTD, the humidity sensor is a capacitance device), mechanical variation, or degradation (wearing of moving parts, contamination of sensors).

Calibration is only useful if you have a known calibrated source you can compare it against, and is optional. This section discusses practices, procedures and sources for sensor calibration to reduce manufacturing

and degradation errors. Do not compare your readings obtained from sources such as the internet, radio, television or newspapers. The purpose of your weather station is to measure conditions of your surroundings, which vary significantly from location to location.

NOTE: UV Calibration MUST be performed every 2 to 3 months to improve results. Over time, UV Index may alter results based on bright and strong sunlight conditions. This is why diligent UV Calibration is recommended.

3.4 Factory reset



3.4.1 Re-register indoor transmitter

Press or key to select re-register indoor transmitter. Press or key to popup the Message Box "Are you sure you want to register the new indoor transmitter?" Press or to select Yes or No. Press the key or key to confirm the selection.

3.4.2 Re-register outdoor transmitter

Please reference section 3.4.1. Procedures and settings are similar to re-register indoor transmitter

3.4.3 Clear History

Please reference section 3.4.1.

3.4.4 Clear Max/Min

Please reference section 3.4.1.

3.4.5 Reset Factory

Please reference section 3.4.1

3.4.6 Backup data

Press or key to select Backup data field, press the or key to enter backup mode:



Press or key to select the history year file. Press key or key to confirm the selection, and the year field will turn from green to purple. Press or to change the activated option field. Press key to start backup, press key again to cancel the backup. Please insert TF card before start backup. The data is stored in comma separated value (csv) file format, which can be opened in Microsoft Excel. The TF card can be read by a computer with an SD card adaptor.



The format of the data is csv (comma separated value) and can be opened in a spreadsheet program such as Microsoft Excel for advanced data analysis, with the following headers:

Column	Parameter
1	No (data point number)
2	Time
3	Indoor Temperature (°F)
4	Indoor Humidity (%)
5	Outdoor Temperature (°F)
6	Outdoor Humidity (%)
7	Dew Point (°F)
8	Wind Chill (°F)
9	Wind (mph)
10	Gust (mph)
11	Wind Direction (°)
12	ABS Barometer (inHg)
13	REL Barometer (inHg)
14	Rain Rate (in/h)
15	Daily Rain (in)
16	Weekly Rain (in)
17	Monthly Rain (in)
18	Yearly Rain (in)
19	Solar Rad. (lux)

3.4.7 Language (English, Chinese, Danish, Dutch, French, German, Italian, Spanish)

3.4.8 About information

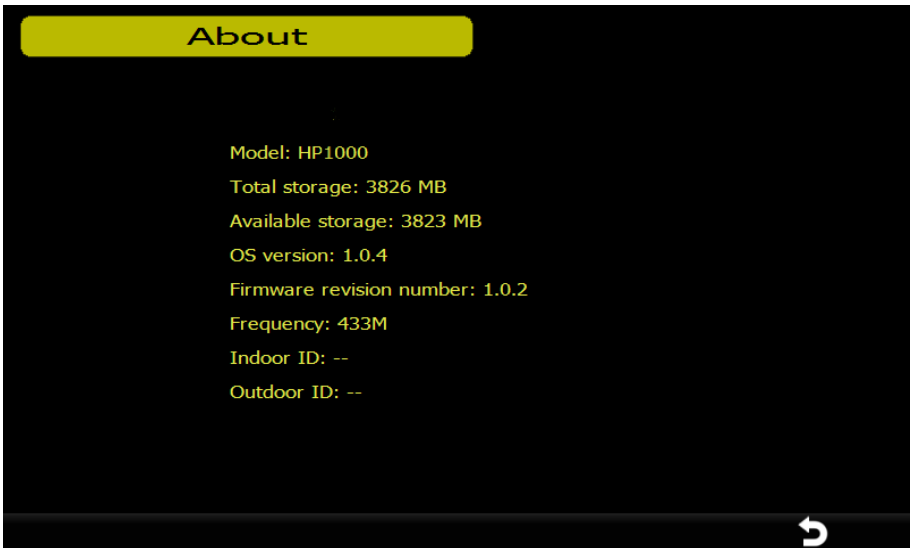

Note: The actual display console may be with higher firmware version and OS version than the manual mention because we will update the firmware and OS occasionally

Maintenance

1. Clean the rain gauge once every 3 months as follows. Reference Figure 11.

Step 1: Make a note of the current rain totals by referencing the calibration screen (reference Section 3.4). You will need to re-enter these values after the calibration procedure it complete.

Step 2: Pour water into the rain collector to moisturize the dirt inside rain bucket.

Step 3: Use an approximately 3 inch (80 mm) long cotton swab, and push the cotton tip through the rain collector hole until it reaches the self emptying mechanism, and press until the mechanism no longer rotates.

Step 4: Rotate the cotton swab back and forth, removing dirt from the tipping mechanism and rain collector hole.

Step 5: Remove the cotton swab and flush with water to remove any remaining dirt.

Step 6: Re-enter the rain totals recorded in Step 1.

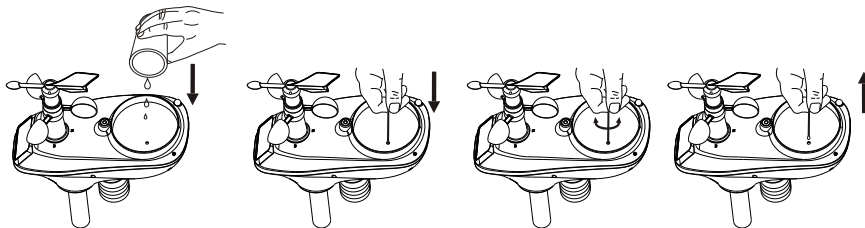



Figure 11

2. Clean the solar radiation sensor every 3 months with water and towel.
3. Replace rechargeable batteries every 2 to 3 years.

Troubleshooting Guide

Problem	Solution
<p>Wireless remote (thermo-hygrometer) not reporting in to console.</p> <p>There are dashes on the display console.</p>	<p>The maximum line of sight communication range is about 600'. Move the sensor assembly closer to the display console.</p> <p>Resynchronize the remote sensor(s). Reference Section 3.4.</p> <p>Install a fresh set of batteries in the remote sensor(s).</p> <p>Make sure the remote sensors are not transmitting through solid metal (acts as an RF shield), or earth barrier (down a hill). Radio Frequency (RF) Sensors cannot transmit through metal barriers (example, aluminum siding) or multiple, thick walls.</p> <p>Move the display console around electrical noise generating devices, such as computers, TVs and other wireless transmitters or receivers.</p>
<p>Outdoor sensor array does not communicate to the display console.</p>	<p>The sensor array may have initiated properly and the data is registered by the console as invalid, and the console must be reset. The reset button is next to the LED, near the mounting point on the sensor array, as shown in figure10.</p> <p>With an open ended paperclip, press the reset button for 3 seconds to completely discharge the voltage.</p> <p>Take out the batteries and wait one minute, while covering the solar panel to drain the voltage.</p> <p>Put batteries back in and resync with console by powering down and up the console with the sensor array about 10 feet away.</p> <p>Bring the sensor array inside the house (you can disconnect it from the rest of the sensors). The LED next to the battery compartment will flash every 16 seconds. If the LED is not flashing every 16 seconds...</p>

Problem	Solution
	<p>Replace the batteries in the outside sensor array. Non-rechargeable batteries are OK for testing purposes. If the batteries were recently replaced, check the polarity. If the sensor is flashing every 48 seconds, proceed to the next step.</p> <p>There may be a temporary loss of communication due to reception loss related to interference or other location factors,</p> <p>or the batteries may have been changed in the sensor array and the console has not been reset. The solution may be as simple as powering down and up the console.</p> <p>Replace the batteries in the outside sensor array. Non-rechargeable batteries are OK for testing purposes.</p> <p>With the sensor array and console 10 feet away from each other, remove AC power from the display console and wait 10 seconds. Re-connect power.</p>
Temperature sensor reads too high in the day time.	<p>Make certain that the sensor array is not too close to heat generating sources or structures, such as buildings, pavement, walls or air conditioning units.</p> <p>Use the calibration feature to offset installation issues related to radiant heat sources. Reference 4.3.</p>
Absolute pressure does not agree with official reporting station	<p>You may be viewing the relative pressure, not the absolute pressure.</p> <p>Select the absolute pressure. Make sure you properly calibrate the sensor to an official local weather station. Reference Section 4.3 for details.</p>
Rain gauge reports rain when it is not raining	<p>An unstable mounting solution (sway in the mounting pole) may result in the tipping bucket incorrectly incrementing rainfall. Make sure you have a stable, level mounting solution.</p>
Data not reporting to Wunderground.com	<ol style="list-style-type: none"> 1. Confirm your password is correct. It is the password you registered on Wunderground.com. Your Wunderground.com password cannot begin with a non-alphanumeric character (a limitation of Wunderground.com, not the station). Example, \$oewkrf is not a valid password, but oewkrf\$ is valid. 2. Confirm your station ID is correct. The station ID is all caps, and the most common issue is substituting an O for a 0 (or visa versa). Example, KAZPHOEN11, not KAZPH0EN11 3. Make sure the date and time is correct on the console. If incorrect, you may be reporting old data, not real time data. 4. Make sure your time zone is set properly. If incorrect, you may be reporting old data, not real time data. 5. Check your router firewall settings. The console sends data via Port 80.
No WiFi connection	<ol style="list-style-type: none"> 1. Check for WiFi signal strength symbol on the display . If wireless connectivity is successful and reporting to Wunderground.com, the WiFi icon  will be displayed under the wind chill display on the home page. 2. Make sure your modem WiFi settings are correct (network name, password and security settings).

Specifications

Outdoor data

Transmission distance in open field	:	100m(330 feet)
Frequency	:	433 MHz / 868 MHz / 915 MHz (option)
Temperature range	:	-30°C--65°C (-22°F to +149°F)
Accuracy	:	+ / - 1 °C
Resolution	:	0.1°C
Measuring range rel. humidity	:	1%~99%
Accuracy	:	+/- 5%
Rain volume display	:	0 – 9999mm (show -- if outside range)
Accuracy	:	+ / - 10%
Resolution	:	0.3mm (if rain volume < 1000mm) 1mm (if rain volume > 1000mm)
Wind speed	:	0-50m/s (0~100mph) (show -- if outside range)
Accuracy:	:	+/- 1m/s (wind speed< 5m/s) +/-10% (wind speed > 5m/s)
Light	:	0-400k Lux
Accuracy	:	+/-15%
Measuring interval outdoor sensor	:	16 sec
Measuring interval indoor sensor	:	64 sec

Indoor data

Indoor temperature range	:	-10°C--60°C (14°F to + 140°F) (show -- if outside range)
Resolution	:	0.1°C
Measuring range rel. humidity	:	1%~99%
Resolution	:	1%
Measuring range air pressure	:	300-1100hPa (8.85-32.5inHg)
Accuracy	:	+/-3hpa under 700-1100hPa
Resolution	:	0.1hPa (0.01inHg)
Alarm duration	:	120 sec

Power consumption

Base station	:	5V DC adaptor (included)
Indoor sensor	:	2xAAA alkaline batteries (not included)
Remote sensor	:	3xAA rechargeable batteries (included)

Remark: Be sure to use 1.5V rechargeable battery for solar transmitter.

Where outdoor temperature is lower than -20°C, make sure proper type of batteries to be used to assure that the device can get enough power to maintain its function properly. Normal alkaline batteries is not allow to be used since when outdoor temperature is lower than -20 °C, the battery's discharging capability is greatly reduced.



Please help in the preservation of the environment and return used batteries to an authorized depot.

All rights reserved. This handbook must not be reproduced in any form, even in excerpts, or duplicated or processed using electronic, mechanical or chemical procedures without written permission of the publisher.

This handbook may contain mistakes and printing errors. The information in this handbook is regularly checked and corrections made in the next issue. We accept no liability for technical mistakes or printing errors, or their consequences.

All trademarks and patents are acknowledged.

Southern Hemisphere - Wind Direction Re-Calibration

Product: Professional Wireless Weather Station

This weather station can be used in both the Northern and Southern Hemispheres.

The cardinal directions (N, S, E, W) molded on the body of the outdoor sensor are indicators for the Northern Hemisphere only. For Southern Hemisphere installations, ignore these and face the solar panel to the North when it comes to installing the outdoor sensor.

Wind Direction Recalibration:

The following procedure is a recalibration guide for the Southern Hemisphere.

- Step 1: Attach the wind vane to the outdoor sensor as described in the User Manual page 4. Note, the wind vane and the shaft have a flat side and must be lined up together.
- Step 2: Insert the batteries in the battery compartment as described in the User Manual page 5.
- Step 3: Align the wind vane pointer with the 'S' marker on the molded body of the outdoor sensor. Use sticky tape or similar to prevent movement.

This is to simulate a North wind direction. Refer photo.

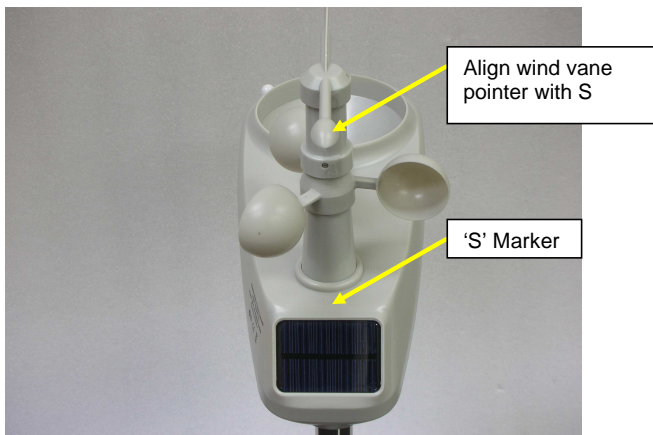

- Step 4: Connect the power adapter to the LCD Screen's power socket. The display will then power up.

The LCD will begin to register the outdoor sensor and receive weather data. Refer photo.

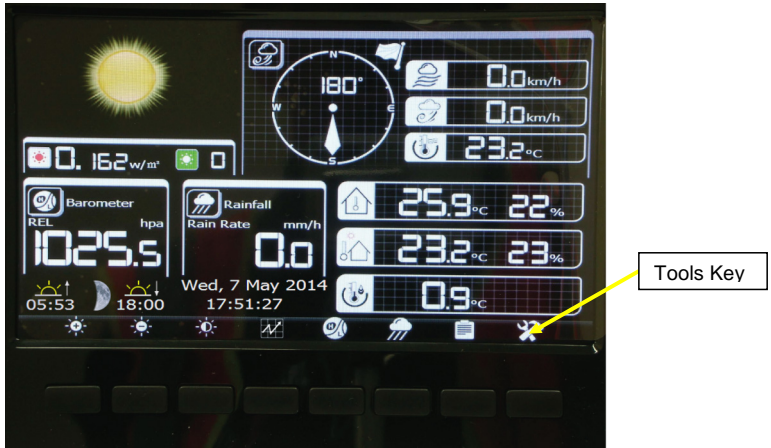

Note, the wind direction will read approximately 180° S. This needs to be recalibrated for the Southern Hemisphere.

- Step 5: Press the Tools (Setting) Key. This will take you into the Setup Menu.
- Press the Tools (Setting) Key again. This will take you into the Alarm menu.
- Press the Tools (Setting) Key again. This will take you into the Calibration Menu. Refer photo.

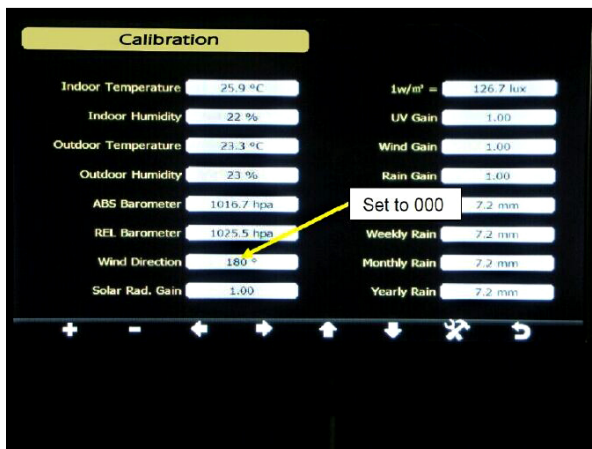

Use the Up/Down Arrow Keys to navigate to and high-light the Wind Direction calibration value which will be approximately 180°. This value is for the Northern Hemisphere.

Use the +/- and Left/Right Keys to set this value to 000°.

Press the Return Key to go back to the Normal Display Mode. The wind direction should now read 0° North. Refer photo.

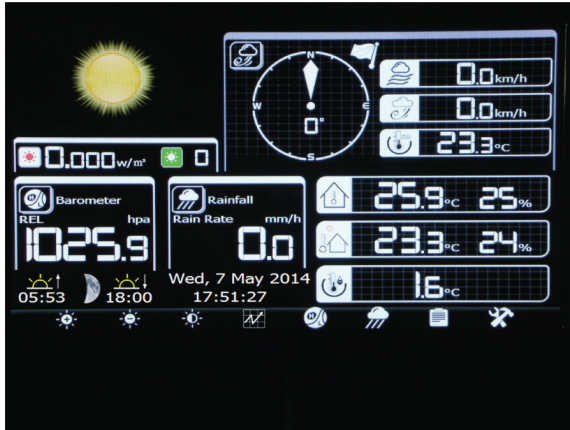

Make sure you remove the sticky tape from the wind vane.

Step 6: Install the Outdoor Sensor outside (and in a sunny position) and face the solar panel North.

- End of Procedure