

NTE10-3

Audio Übertrager 1:3:10

Eingangs-/ Ausgangsimpedanz in : 200/50K

Max. Eingangsspannung (1% THD @ 60 Hz): 500 mV rms

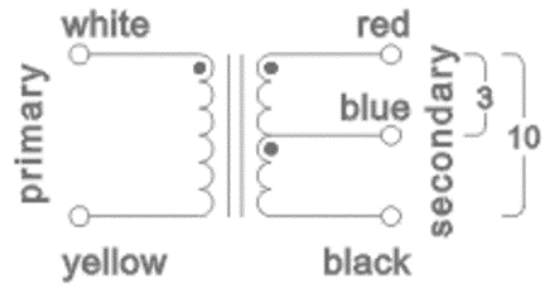
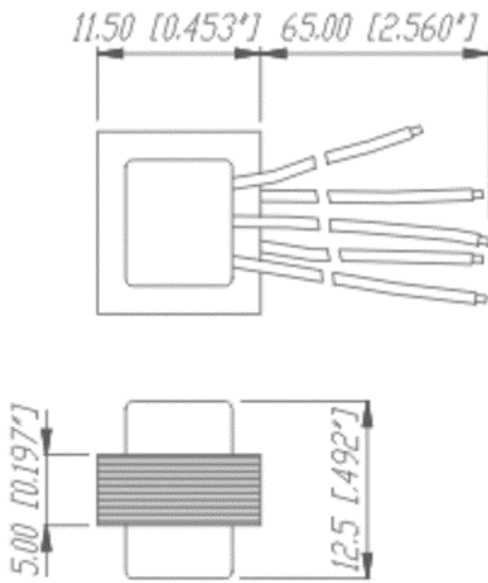

# Transformers

	Ripple 20Hz-20kHz	Max. input voltage (@60Hz) THD $\leq$ 1%		THD $\leq$ 3%	Min. load impedance
<b>NTE1</b>	max. -1dB	1,2 V	1,4 V		200 $\Omega$
<b>NTE4</b>	max. -1dB	1,6 V	2,2 V		1 k $\Omega$
<b>NTE10/3</b>	max. -2dB	1,2 V	1,6 V		10 k $\Omega$
	Turns ratio	Winding resistance (DC)			Primary inductance at 30Hz
		primary	secondary		
<b>NTL1</b>	1 : 1 $\pm$ 5%	1.1 k $\Omega$ $\pm$ 5%	1.35 k $\Omega$ $\pm$ 5%		$\geq$ 150 H
<b>NTM1</b>	1 : 1 $\pm$ 10%	85 $\Omega$ $\pm$ 3%	105 $\Omega$ $\pm$ 5%		$\geq$ 8 H
<b>NTM4</b>	1 : 4 $\pm$ 10%	105 $\Omega$ $\pm$ 3%	1.25 k $\Omega$ $\pm$ 5%		$\geq$ 8 H

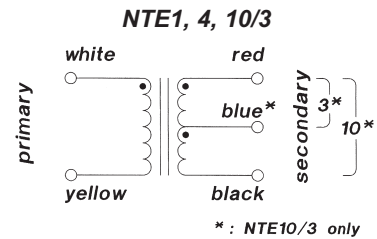

**NTL1, NTM1, 4**

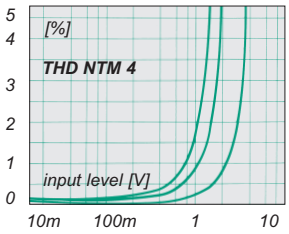
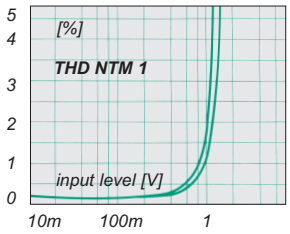
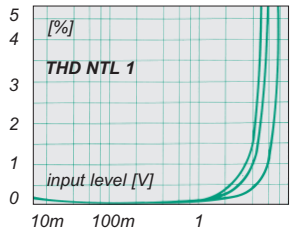
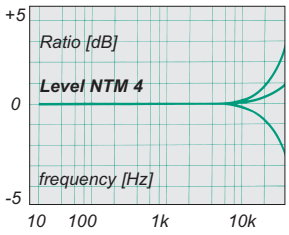
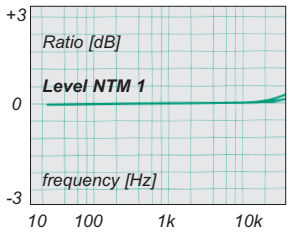
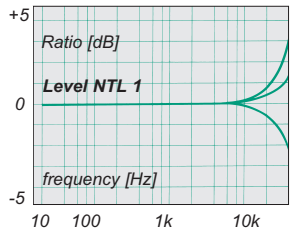
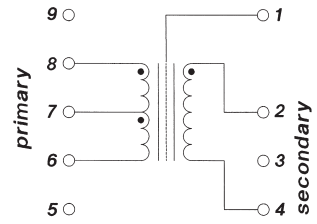

**NTL1: typical application**

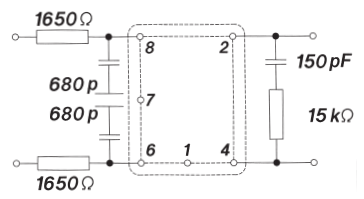

## Audio Übertrager

- Professionelle Audio Übertrager für verschiedene Anwendungen wie z.B. Mikrofon oder Line Inputs
- Sehr niedrige Distorsion, exzellente Frequenzkurve
- Kostengünstige Kabelversion für freies Anschliessen
- Voll Permalloy geschirmte Studio Version

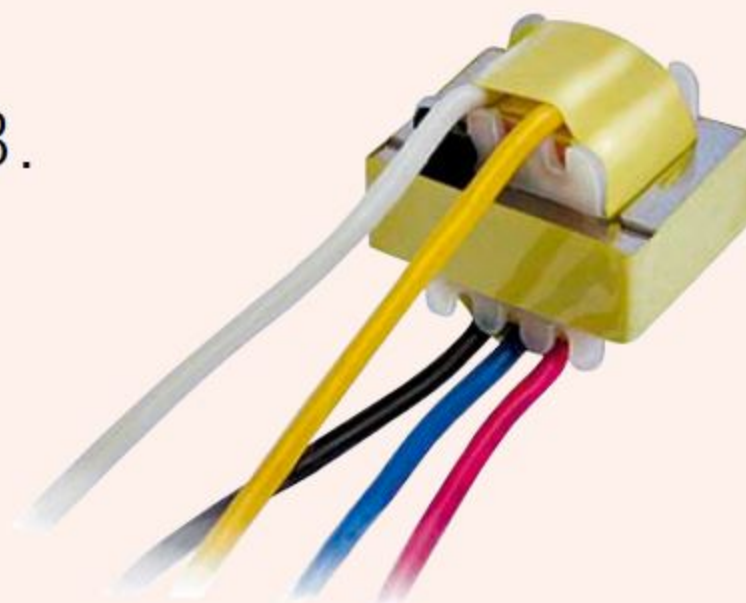

NTE10-3



NTL1

## Liste Audio Übertrager

Artikelnr.	Windungszahl- verhältnis (prim : sec)	Impedanz- verhältnis	Eingangs- / Ausgangs- impedanz in $\Omega$	Max. Eingangs- pegel* @ 50 Hz, 1% THD [dBu]	Anwendungen
NTE1	1 : 1	200 : 200	200 / 2k, (600 / 10k)	-3	Generell, Signalverteilung, elektr. Trennung
NTE4	1 : 4	200 : 3.2k	200 / 10 K	-7	Mikrofon Eingang Pegelanpassung
NTE10/3	1 : 3	200 : 1.8k	200 / 10 K	-7	Allg. Mikrofon Eingang Pegelanpassung
	1 : 10	200 : 20k	200 / 50 K	-6	
NTL1	1 : 1	10k : 10k	600 / 10k	+19	Line Eingang
NTM1	1 : 1	200 : 200	200 / 2k	+7	Mikrofon Eingang, Signalverteilung
NTM4	1 : 4	200 : 3.2k	200 / 10k	+9	Mikrofon Eingang, Pegelanpassung

\* gemessen mit typischen Source / Load Impedanzen

Anschluss: NTE\*... freie Kabel, NTL / NTM\*... Printmontage, geschirmt; Mehr Infos auf [www.neutrik.com](http://www.neutrik.com)

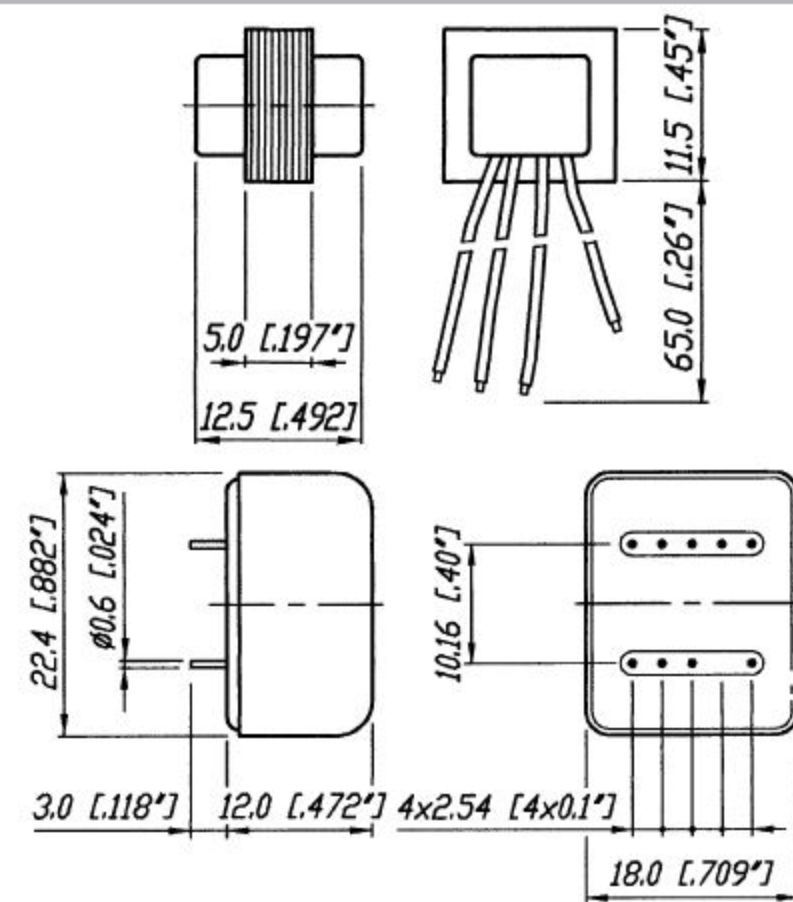

## Audio Transformer

- Professional audio transformers for multiple applications, as e.g. microphone or line inputs
- Very low distortion, excellent frequency response
- Cost effective cable version for free wiring
- Fully permalloy-shielded studio versions

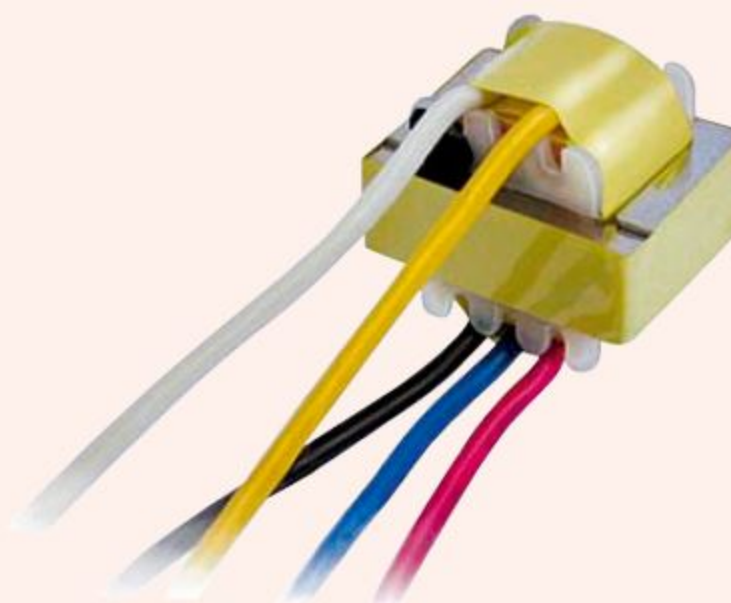

NTE10-3



NTL1

## Audio Transformer selection Guide

Part No.	Turns Ratio (prim : sec)	Impedance ratio	Source / load impedance in $\Omega$	Max. Input level* @ 50 Hz, 1% THD [dBu]	Applications
NTE1	1 : 1	200 : 200	200 / 2k, (600 / 10k)	-3	General purpose, splitting, XLR inline
NTE4	1 : 4	200 : 3.2k	200 / 10 K	-7	Mic input step-up
NTE10/3	1 : 3	200 : 1.8k	200 / 10 K	-7	General purpose mic input step-up
	1 : 10	200 : 20k	200 / 50 K	-6	
NTL1	1 : 1	10k : 10k	600 / 10k	+19	Line input
NTM1	1 : 1	200 : 200	200 / 2k	+7	Mic input, splitting
NTM4	1 : 4	200 : 3.2k	200 / 10k	+9	Mic input step-up

\* : measured with typical source / load impedances

Wiring: NTE\*: free wires, NTL / NTM\*... PCB mount, shielded; Find detailed specifications on [www.neutrik.com](http://www.neutrik.com)

