

MEGASAT

Montageanleitung/Mounting Instruction

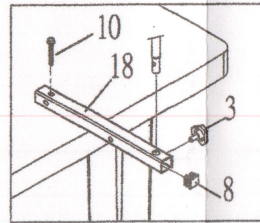

Table+Selftap screw

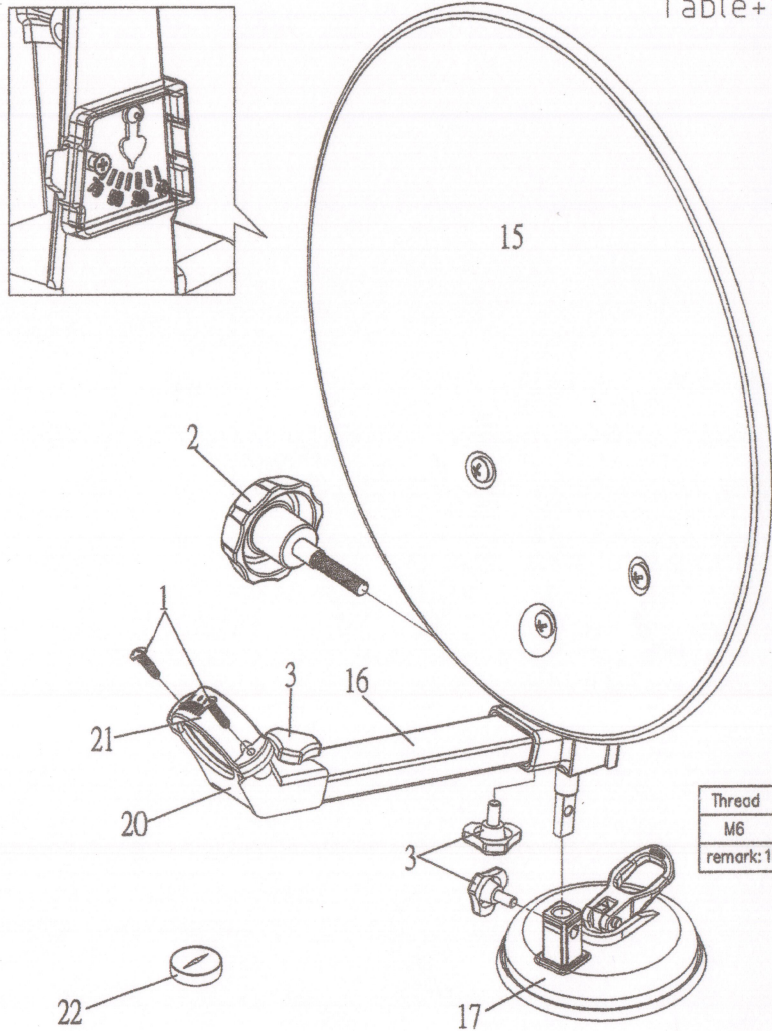
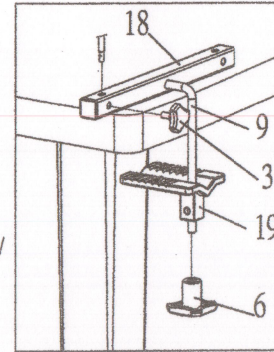

L Type Rod
Adjust+Fix plate
on Table

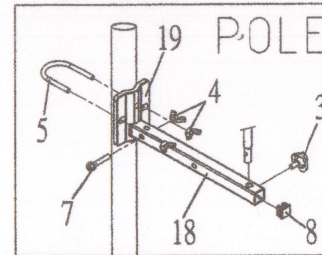

POLE

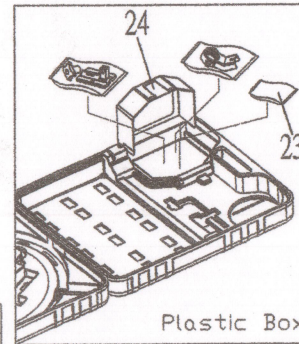

Plastic Box

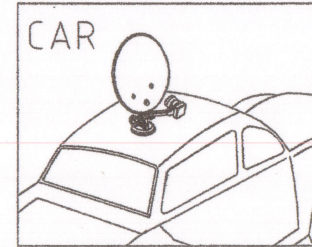

CAR

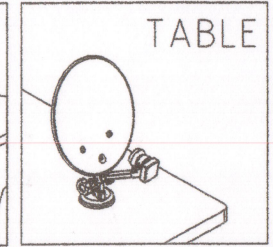

TABLE

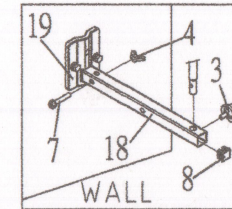

WALL

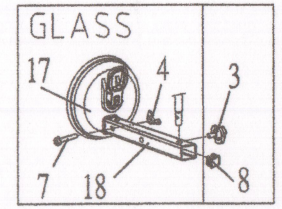

GLASS

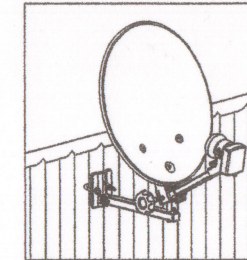

Handrail
Vertical position

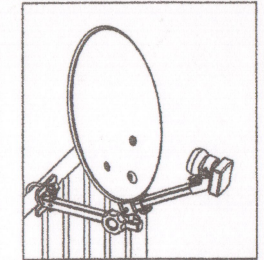

Handrail
Horizontal position

Thread	Max Tightening torques
M6	8.8N.m 90Kgf.cm

remark: 1N.m=10.197Kgf.cm

24		Tool box cover	1
23		Screw kit	1
22		COMPASS	1
21		40mm LNBF Clamp	1
20		40mm LNBF Clamp Holder	1
19		Fix plate	1

18		Extention rod	1
17		Base	1
16		LNBF Arm	1
15		Reflector w/Bracket	1
10		1/4"*2" drill self screw	1
9		L Type Rod Adjust	1
8		Plug	1
7		M6*35 Hex-head cap screw W/W	1
6		M8 Knob nut	1
5		M6*W38 U Bolt	1
4		M6 Wing nut	3
3		M6 knob bolt	3
2		M8 Knob nut	1
1		ø4*5/8" self-drilling screw	2
NO.	ITEM	DESCRIPTION	Q'TY