

**Data sheet | Item number: 787-885**

Redundancy Module; 2 x 24 VDC input voltage; 2 x 20 A input current; 24 VDC output voltage; 40 A output current; communication capability

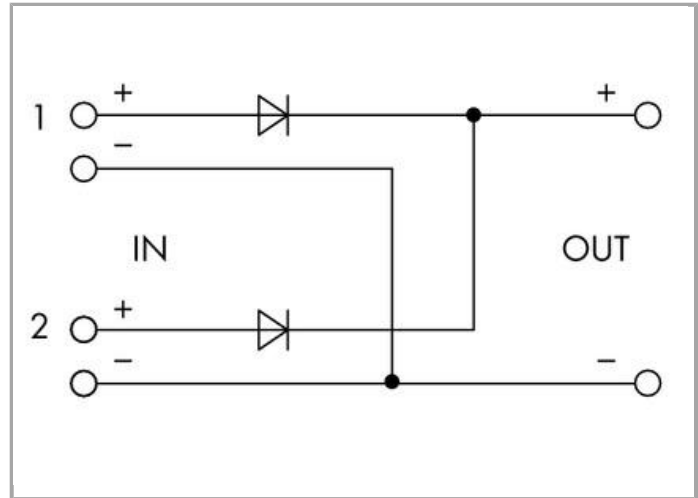

[www.wago.com/787-885](http://www.wago.com/787-885)



**Item description**

**Features:**

—

- Redundancy module with two inputs for decoupling two power supplies
- For redundant and fail-safe power supply
- With LED and potential-free contact for input voltage monitoring on site and remotely

## Data

### Technical Data

#### Input

Number of inputs	2
Nominal input voltage $U_{i\text{ nom}}$	2 x 24 VDC
Input voltage range	2 x 18 ... 30 VDC
Nominal mains frequency range	0 Hz
Input current $I_i$	$\leq 20$ A (per path)

#### Output

Nominal output voltage $U_{o\text{ nom}}$	24 VDC
Output voltage range	18 ... 30 VDC ( $U_i$ – voltage drop)
Voltage drop	$\leq 0.6$ V (input/output)
Nominal output current $I_{o\text{ nom}}$	40 A
Nominal output power	960 W
Max. output power	$\leq \leq 1200$ W

#### Signaling and communication

Signaling	1 x LED OUT (green) 1 x LED IN1 (yellow) 1 x LED IN2 (yellow) 1 x potential-free relay contact (max. 30 VDC, 1 A)
Operation status indicator	LED green ( $U_o$ ) 2 x LED yellow ( $U_i$ )

#### Efficiency/Power losses:

Power loss $P_v$	1.5 W (no load); 14 W (24 VDC; 20 A); 26 W (48 VDC; 40 A)
Efficiency	97 %

#### Fuse protection:

Internal fuse	No
---------------	----

### Safety and protection:

Insulation voltage (connectors-housing)	0.5 kV DC
Protection class	III
Degree of protection	IP20 (per EN 60529)
Reverse voltage protection	yes
Feedback voltage	≤ 33VDC
Parallel operation	Yes
Series connection	No
MTBF	> 500,000 h (per IEC 61709)

### Connection data

Connection type (1)	Input/Output
Connection technology	Push-in CAGE CLAMP®
WAGO terminal	WAGO 831 Series
Solid conductor	0.5 ... 10 mm <sup>2</sup> / 20 ... 8 AWG
Fine-stranded conductor	0.5 ... 10 mm <sup>2</sup> / 20 ... 8 AWG
Strip length	13 ... 15 mm / 0.51 ... 0.59 Inch
Connection type (2)	Relay
Connection technology 2	CAGE CLAMP®
WAGO terminal 2	WAGO 231 Series
Solid conductor (2)	0.08 ... 2.5 mm <sup>2</sup> / 28 ... 12 AWG
Fine-stranded conductor (2)	0.08 ... 2.5 mm <sup>2</sup> / 28 ... 12 AWG
Strip length (2)	8 ... 9 mm / 0.31 ... 0.35 Inch

### Geometrical Data

Width	40 mm / 1.575 inch
Height	181 mm / 7.126 inch
Length from upper-edge of DIN-35 rail	163 mm / 6.417 inch
Note on dimensions	Height including pluggable connector

### Mechanical data

Type of mounting	DIN-35 rail (EN 60715) in 2 positions
------------------	---------------------------------------

### Material Data

Weight	870 g
--------	-------

### Environmental Requirements

Surrounding air (operating) temperature	-10 ... 60 °C
---	---------------

Surrounding air (storage) temperature	-25 ... 85 °C
Relative humidity	5 ... 96 % (no condensation permissible)
Pollution degree	2

## Standards and specifications



Conformity marking	CE
Standards/specifications	EN 60950; UL 60950; UL 508; EN 61000-6-2; EN 61000-6-3

## Commercial data







Country of origin	DE
GTIN	4045454909802
Customs Tariff No.	85044090900
Product Group	6 (Interface Electronics)

















## Compatible products

### tools

	<b>Item no.: 210-720</b> Operating tool with partially insulated shaft; Type 2, blade (3.5 x 0.5) mm	<a href="http://www.wago.com/210-720">www.wago.com/210-720</a>
	<b>Item no.: 210-721</b> Operating tool with partially insulated shaft; Type 3, blade (5.5 x 0.8) mm	<a href="http://www.wago.com/210-721">www.wago.com/210-721</a>

### Marking accessories

	<b>Item no.: 2009-110</b> Marking strips; on reel; not stretchable; plain; snap-on type	<a href="http://www.wago.com/2009-110">www.wago.com/2009-110</a>
	<b>Item no.: 2009-115</b> WMB-Inline; for smartPRINTER; on reel; stretchable 5 - 5.2 mm; plain; snap-on type	<a href="http://www.wago.com/2009-115">www.wago.com/2009-115</a>
	<b>Item no.: 2009-115/000-002</b> WMB-Inline; for smartPRINTER; on reel; stretchable 5 - 5.2 mm; plain; snap-on type	<a href="http://www.wago.com/2009-115/000-002">www.wago.com/2009-115/000-002</a>
	<b>Item no.: 2009-115/000-006</b> WMB-Inline; for smartPRINTER; on reel; stretchable 5 - 5.2 mm; plain; snap-on type	<a href="http://www.wago.com/2009-115/000-006">www.wago.com/2009-115/000-006</a>
	<b>Item no.: 2009-115/000-007</b> WMB-Inline; for smartPRINTER; on reel; stretchable 5 - 5.2 mm; plain; snap-on type	<a href="http://www.wago.com/2009-115/000-007">www.wago.com/2009-115/000-007</a>
	<b>Item no.: 2009-115/000-012</b> WMB-Inline; for smartPRINTER; on reel; stretchable 5 - 5.2 mm; plain; snap-on type	<a href="http://www.wago.com/2009-115/000-012">www.wago.com/2009-115/000-012</a>
	<b>Item no.: 2009-115/000-017</b> WMB-Inline; for smartPRINTER; on reel; stretchable 5 - 5.2 mm; plain; snap-on type	<a href="http://www.wago.com/2009-115/000-017">www.wago.com/2009-115/000-017</a>

	<p><b>Item no.: 2009-115/000-023</b> WMB-Inline; for smartPRINTER; on reel; stretchable 5 - 5.2 mm; plain; snap-on type</p>	<a href="http://www.wago.com/2009-115/000-023">www.wago.com/2009-115/000-023</a>
	<p><b>Item no.: 2009-115/000-024</b> WMB-Inline; for smartPRINTER; on reel; stretchable 5 - 5.2 mm; plain; snap-on type</p>	<a href="http://www.wago.com/2009-115/000-024">www.wago.com/2009-115/000-024</a>
	<p><b>Item no.: 2009-135</b> WMB-Inline; for smartPRINTER; on reel; stretchable 5 - 5.2 mm; plain; snap-on type</p>	<a href="http://www.wago.com/2009-135">www.wago.com/2009-135</a>
	<p><b>Item no.: 2009-145</b> Mini-WSB Inline; for smartPRINTER; on reel; stretchable 5 - 5.2 mm; plain; snap-on type</p>	<a href="http://www.wago.com/2009-145">www.wago.com/2009-145</a>
	<p><b>Item no.: 2009-145/000-002</b> Mini-WSB Inline; for smartPRINTER; on reel; stretchable 5 - 5.2 mm; plain; snap-on type</p>	<a href="http://www.wago.com/2009-145/000-002">www.wago.com/2009-145/000-002</a>
	<p><b>Item no.: 2009-145/000-005</b> Mini-WSB Inline; for smartPRINTER; on reel; stretchable 5 - 5.2 mm; plain; snap-on type</p>	<a href="http://www.wago.com/2009-145/000-005">www.wago.com/2009-145/000-005</a>
	<p><b>Item no.: 2009-145/000-006</b> Mini-WSB Inline; for smartPRINTER; on reel; stretchable 5 - 5.2 mm; plain; snap-on type</p>	<a href="http://www.wago.com/2009-145/000-006">www.wago.com/2009-145/000-006</a>
	<p><b>Item no.: 2009-145/000-007</b> Mini-WSB Inline; for smartPRINTER; on reel; stretchable 5 - 5.2 mm; plain; snap-on type</p>	<a href="http://www.wago.com/2009-145/000-007">www.wago.com/2009-145/000-007</a>
	<p><b>Item no.: 2009-145/000-012</b> Mini-WSB Inline; for smartPRINTER; on reel; stretchable 5 - 5.2 mm; plain; snap-on type</p>	<a href="http://www.wago.com/2009-145/000-012">www.wago.com/2009-145/000-012</a>
	<p><b>Item no.: 2009-145/000-023</b> Mini-WSB Inline; for smartPRINTER; on reel; stretchable 5 - 5.2 mm; plain; snap-on type</p>	<a href="http://www.wago.com/2009-145/000-023">www.wago.com/2009-145/000-023</a>
	<p><b>Item no.: 2009-145/000-024</b> Mini-WSB Inline; on reel; stretchable 5 - 5.2 mm; plain; snap-on type</p>	<a href="http://www.wago.com/2009-145/000-024">www.wago.com/2009-145/000-024</a>
	<p><b>Item no.: 210-831</b> Marking strips; on reel; 2.3 mm wide; plain; Self-adhesive</p>	<a href="http://www.wago.com/210-831">www.wago.com/210-831</a>
	<p><b>Item no.: 210-832</b> Marking strips; on reel; 3 mm wide; plain; Self-adhesive</p>	<a href="http://www.wago.com/210-832">www.wago.com/210-832</a>
	<p><b>Item no.: 248-501</b> Miniature WSB Quick marking system; plain; Marker width 5 mm; 10 strips with 10 markers per card</p>	<a href="http://www.wago.com/248-501">www.wago.com/248-501</a>
	<p><b>Item no.: 248-501/000-002</b> Mini-WSB marking card; as card; not stretchable; plain; snap-on type</p>	<a href="http://www.wago.com/248-501/000-002">www.wago.com/248-501/000-002</a>
	<p><b>Item no.: 248-501/000-005</b> Mini-WSB marking card; as card; plain; snap-on type</p>	<a href="http://www.wago.com/248-501/000-005">www.wago.com/248-501/000-005</a>



**Item no.: 248-501/000-006**  
Mini-WSB marking card; as card; not stretchable; plain; snap-on type

[www.wago.com/248-501/000-006](http://www.wago.com/248-501/000-006)



**Item no.: 248-501/000-007**  
Mini-WSB marking card; as card; not stretchable; plain; snap-on type

[www.wago.com/248-501/000-007](http://www.wago.com/248-501/000-007)



**Item no.: 248-501/000-012**  
Mini-WSB marking card; as card; not stretchable; plain; snap-on type

[www.wago.com/248-501/000-012](http://www.wago.com/248-501/000-012)



**Item no.: 248-501/000-017**  
Mini-WSB marking card; as card; not stretchable; plain; snap-on type

[www.wago.com/248-501/000-017](http://www.wago.com/248-501/000-017)



**Item no.: 248-501/000-023**  
Mini-WSB marking card; as card; not stretchable; plain; snap-on type

[www.wago.com/248-501/000-023](http://www.wago.com/248-501/000-023)



**Item no.: 793-501**  
WMB marking card; as card; not stretchable; plain; snap-on type

[www.wago.com/793-501](http://www.wago.com/793-501)



**Item no.: 793-501/000-002**  
WMB marking card; as card; not stretchable; plain; snap-on type

[www.wago.com/793-501/000-002](http://www.wago.com/793-501/000-002)



**Item no.: 793-501/000-005**  
WMB marking card; as card; not stretchable; plain; snap-on type

[www.wago.com/793-501/000-005](http://www.wago.com/793-501/000-005)



**Item no.: 793-501/000-006**  
WMB marking card; as card; not stretchable; plain; snap-on type

[www.wago.com/793-501/000-006](http://www.wago.com/793-501/000-006)



**Item no.: 793-501/000-007**  
WMB marking card; as card; not stretchable; plain; snap-on type

[www.wago.com/793-501/000-007](http://www.wago.com/793-501/000-007)



**Item no.: 793-501/000-012**  
WMB marking card; as card; not stretchable; plain; snap-on type

[www.wago.com/793-501/000-012](http://www.wago.com/793-501/000-012)



**Item no.: 793-501/000-017**  
WMB marking card; as card; not stretchable; plain; snap-on type

[www.wago.com/793-501/000-017](http://www.wago.com/793-501/000-017)



**Item no.: 793-501/000-023**  
WMB marking card; as card; not stretchable; plain; snap-on type

[www.wago.com/793-501/000-023](http://www.wago.com/793-501/000-023)



**Item no.: 793-501/000-024**  
WMB marking card; as card; not stretchable; plain; snap-on type

[www.wago.com/793-501/000-024](http://www.wago.com/793-501/000-024)



**Item no.: 793-5501**  
WMB marking card; as card; for terminal block width 5 - 17.5 mm; stretchable 5 - 5.2 mm; plain; snap-on type

[www.wago.com/793-5501](http://www.wago.com/793-5501)

**Item no.: 793-5501/000-002**

[www.wago.com/793-5501/000-002](http://www.wago.com/793-5501/000-002)



WMB marking card; as card; for terminal block width 5 - 17.5 mm; stretchable 5 - 5.2 mm; plain; snap-on type [www.wago.com/793-5501/000-002](http://www.wago.com/793-5501/000-002)



**Item no.: 793-5501/000-005**  
WMB marking card; as card; stretchable 5 - 5.2 mm; plain; snap-on type [www.wago.com/793-5501/000-005](http://www.wago.com/793-5501/000-005)



**Item no.: 793-5501/000-006**  
WMB marking card; as card; stretchable 5 - 5.2 mm; plain; snap-on type [www.wago.com/793-5501/000-006](http://www.wago.com/793-5501/000-006)



**Item no.: 793-5501/000-007**  
WMB marking card; as card; stretchable 5 - 5.2 mm; plain; snap-on type [www.wago.com/793-5501/000-007](http://www.wago.com/793-5501/000-007)



**Item no.: 793-5501/000-012**  
WMB marking card; as card; stretchable 5 - 5.2 mm; plain; snap-on type [www.wago.com/793-5501/000-012](http://www.wago.com/793-5501/000-012)



**Item no.: 793-5501/000-017**  
WMB marking card; as card; stretchable 5 - 5.2 mm; plain; snap-on type [www.wago.com/793-5501/000-017](http://www.wago.com/793-5501/000-017)



**Item no.: 793-5501/000-023**  
WMB marking card; as card; stretchable 5 - 5.2 mm; plain; snap-on type [www.wago.com/793-5501/000-023](http://www.wago.com/793-5501/000-023)



**Item no.: 793-5501/000-024**  
WMB marking card; as card; stretchable 5 - 5.2 mm; plain; snap-on type [www.wago.com/793-5501/000-024](http://www.wago.com/793-5501/000-024)

### Mounting adapter

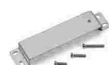

**Item no.: 787-895**  
EPSITRON® wall mount adapter; for screw fixing of 787-8xx devices on mounting plate or wall without DIN 35 rail [www.wago.com/787-895](http://www.wago.com/787-895)



**Item no.: 787-896**  
Carrier rail adapter; for mounting 787-8xx devices to a DIN 35 rail [www.wago.com/787-896](http://www.wago.com/787-896)



**Item no.: 787-897**  
Carrier rail adapter made of zinc die-cast; for mounting 787-8xx devices to a DIN 35 rail [www.wago.com/787-897](http://www.wago.com/787-897)

### ferrule



**Item no.: 216-201**  
Ferrule; Sleeve for 0.5 mm<sup>2</sup> / AWG 22; insulated; electro-tin plated [www.wago.com/216-201](http://www.wago.com/216-201)





















**Item no.: 216-202**  
Ferrule; Sleeve for 0.75 mm<sup>2</sup> / AWG 20; insulated; electro-tin plated [www.wago.com/216-202](http://www.wago.com/216-202)











**Item no.: 216-203**  
Ferrule; Sleeve for 1 mm<sup>2</sup> / AWG 18; insulated; electro-tin plated [www.wago.com/216-203](http://www.wago.com/216-203)



**Item no.: 216-204**  
Ferrule; Sleeve for 1.5 mm<sup>2</sup> / AWG 16; insulated; electro-tin plated [www.wago.com/216-204](http://www.wago.com/216-204)

	<b>Item no.: 216-205</b> Ferrule; Sleeve for 2.08 mm <sup>2</sup> / AWG 14; insulated; electro-tin plated	<a href="http://www.wago.com/216-205">www.wago.com/216-205</a>
	<b>Item no.: 216-206</b> Ferrule; Sleeve for 2.5 mm <sup>2</sup> / AWG 14; insulated; electro-tin plated	<a href="http://www.wago.com/216-206">www.wago.com/216-206</a>
	<b>Item no.: 216-207</b> Ferrule; Sleeve for 4 mm <sup>2</sup> / AWG 12; insulated; electro-tin plated	<a href="http://www.wago.com/216-207">www.wago.com/216-207</a>
	<b>Item no.: 216-208</b> Ferrule; Sleeve for 6 mm <sup>2</sup> / AWG 10; insulated; electro-tin plated; electrolytic copper; gastight crimped; acc. to DIN 46228, Part 4/09.90	<a href="http://www.wago.com/216-208">www.wago.com/216-208</a>
	<b>Item no.: 216-221</b> Ferrule; Sleeve for 0.5 mm <sup>2</sup> / AWG 22; insulated; electro-tin plated	<a href="http://www.wago.com/216-221">www.wago.com/216-221</a>
	<b>Item no.: 216-222</b> Ferrule; Sleeve for 0.75 mm <sup>2</sup> / AWG 20; insulated; electro-tin plated	<a href="http://www.wago.com/216-222">www.wago.com/216-222</a>
	<b>Item no.: 216-223</b> Ferrule; Sleeve for 1 mm <sup>2</sup> / AWG 18; insulated; electro-tin plated	<a href="http://www.wago.com/216-223">www.wago.com/216-223</a>
	<b>Item no.: 216-224</b> Ferrule; Sleeve for 1.5 mm <sup>2</sup> / AWG 16; insulated; electro-tin plated	<a href="http://www.wago.com/216-224">www.wago.com/216-224</a>
	<b>Item no.: 216-241</b> Ferrule; Sleeve for 0.5 mm <sup>2</sup> / AWG 22; insulated; electro-tin plated; electrolytic copper; gastight crimped; acc. to DIN 46228, Part 4/09.90	<a href="http://www.wago.com/216-241">www.wago.com/216-241</a>
	<b>Item no.: 216-242</b> Ferrule; Sleeve for 0.75 mm <sup>2</sup> / AWG 20; insulated; electro-tin plated; electrolytic copper; gastight crimped; acc. to DIN 46228, Part 4/09.90	<a href="http://www.wago.com/216-242">www.wago.com/216-242</a>
	<b>Item no.: 216-243</b> Ferrule; Sleeve for 1 mm <sup>2</sup> / AWG 18; insulated; electro-tin plated; electrolytic copper; gastight crimped; acc. to DIN 46228, Part 4/09.90	<a href="http://www.wago.com/216-243">www.wago.com/216-243</a>
	<b>Item no.: 216-244</b> Ferrule; Sleeve for 1.5 mm <sup>2</sup> / AWG 16; insulated; electro-tin plated; electrolytic copper; gastight crimped; acc. to DIN 46228, Part 4/09.90	<a href="http://www.wago.com/216-244">www.wago.com/216-244</a>
	<b>Item no.: 216-246</b> Ferrule; Sleeve for 2.5 mm <sup>2</sup> / AWG 14; insulated; electro-tin plated; electrolytic copper; gastight crimped; acc. to DIN 46228, Part 4/09.90	<a href="http://www.wago.com/216-246">www.wago.com/216-246</a>
	<b>Item no.: 216-262</b> Ferrule; Sleeve for 0.75 mm <sup>2</sup> / AWG 20; insulated; electro-tin plated; electrolytic copper; gastight crimped; acc. to DIN 46228, Part 4/09.90	<a href="http://www.wago.com/216-262">www.wago.com/216-262</a>
	<b>Item no.: 216-263</b> Ferrule; Sleeve for 1 mm <sup>2</sup> / AWG 18; insulated; electro-tin plated; electrolytic copper; gastight crimped; acc. to DIN 46228, Part 4/09.90	<a href="http://www.wago.com/216-263">www.wago.com/216-263</a>
	<b>Item no.: 216-264</b> Ferrule; Sleeve for 1.5 mm <sup>2</sup> / AWG 16; insulated; electro-tin plated; electrolytic copper; gastight crimped; acc. to DIN 46228, Part 4/09.90	<a href="http://www.wago.com/216-264">www.wago.com/216-264</a>
	<b>Item no.: 216-266</b> Ferrule; Sleeve for 2.5 mm <sup>2</sup> / AWG 14; insulated; electro-tin plated; electrolytic copper; gastight crimped; acc. to DIN 46228, Part 4/09.90	<a href="http://www.wago.com/216-266">www.wago.com/216-266</a>
	<b>Item no.: 216-267</b> Ferrule; Sleeve for 4 mm <sup>2</sup> / AWG 12; insulated; electro-tin plated; electrolytic copper; gastight crimped; acc. to DIN 46228, Part 4/09.90	<a href="http://www.wago.com/216-267">www.wago.com/216-267</a>
	<b>Item no.: 216-284</b>	



	Ferrule; Sleeve for 1.5 mm <sup>2</sup> / AWG 16; insulated; electro-tin plated; electrolytic copper; gastight crimped; acc. to DIN 46228, Part 4/09.90	<a href="http://www.wago.com/216-284">www.wago.com/216-284</a>
	<b>Item no.: 216-286</b> Ferrule; Sleeve for 2.5 mm <sup>2</sup> / AWG 14; insulated; electro-tin plated; electrolytic copper; gastight crimped; acc. to DIN 46228, Part 4/09.90	<a href="http://www.wago.com/216-286">www.wago.com/216-286</a>
	<b>Item no.: 216-287</b> Ferrule; Sleeve for 4 mm <sup>2</sup> / AWG 12; insulated; electro-tin plated; electrolytic copper; gastight crimped; acc. to DIN 46228, Part 4/09.90	<a href="http://www.wago.com/216-287">www.wago.com/216-287</a>
	<b>Item no.: 216-288</b> Ferrule; Sleeve for 6 mm <sup>2</sup> / AWG 10; insulated; electro-tin plated; electrolytic copper; gastight crimped; acc. to DIN 46228, Part 4/09.90	<a href="http://www.wago.com/216-288">www.wago.com/216-288</a>
	<b>Item no.: 216-301</b> Ferrule; Sleeve for 0.25 mm <sup>2</sup> / AWG 24; insulated; electro-tin plated	<a href="http://www.wago.com/216-301">www.wago.com/216-301</a>
	<b>Item no.: 216-302</b> Ferrule; Sleeve for 0.34 mm <sup>2</sup> / AWG 24; insulated; electro-tin plated	<a href="http://www.wago.com/216-302">www.wago.com/216-302</a>
	<b>Item no.: 216-321</b> Ferrule; Sleeve for 0.25 mm <sup>2</sup> / AWG 24; insulated; electro-tin plated	<a href="http://www.wago.com/216-321">www.wago.com/216-321</a>
	<b>Item no.: 216-322</b> Ferrule; Sleeve for 0.34 mm <sup>2</sup> / AWG 24; insulated; electro-tin plated	<a href="http://www.wago.com/216-322">www.wago.com/216-322</a>

## Downloads

### Documentation

#### Bid Text

787-885 Stromversorgung EPSITRON	Jan 14, 2016	DOC 36.9 kB	Download
-------------------------------------	--------------	----------------	----------

#### Instruction Leaflet

EPSITRON Redundant Module 24 VDC, 20 A	Jun 24, 2016	PDF 278.8 kB	Download
---	--------------	-----------------	----------

#### Additional Information

Disposal; Electrical and electronic equipment, Packaging	Oct 15, 2018	265.8 kB	Download
--	--------------	----------	----------

## smartDATA

### CAD data

3D Download 787-885	URL	Download
---------------------	-----	----------



## Product family

EPSITRON System Modules

EPSITRON®: Advanced Power Supply System

[Show all products from the family](#)

Subject to changes.

---

WAGO Kontakttechnik GmbH & Co. KG

Hansastr. 27

32423 Minden

Phone: +49571 887-0 | Fax: +49571 887-169

Email: [info.de@wago.com](mailto:info.de@wago.com) | Web: [www.wago.com](http://www.wago.com)

Do you have any questions about our products?

We are always happy to take your call at +49 (571) 887-44222.