

# 1591L Enclosure

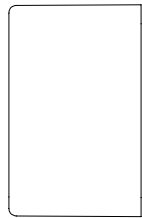

SIDE VIEW OF BOX

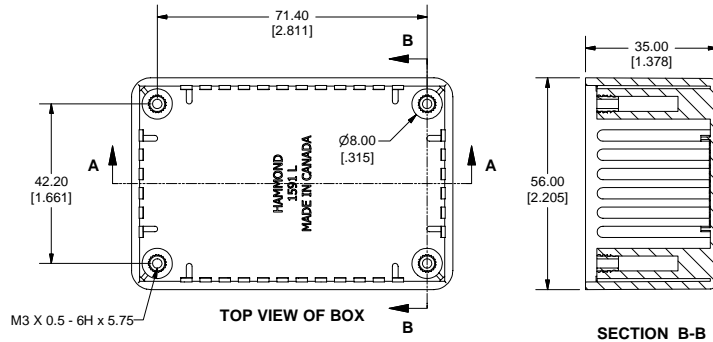

TOP VIEW OF BOX

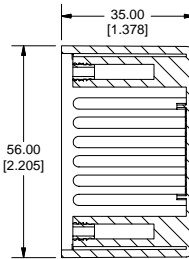

SECTION B-B

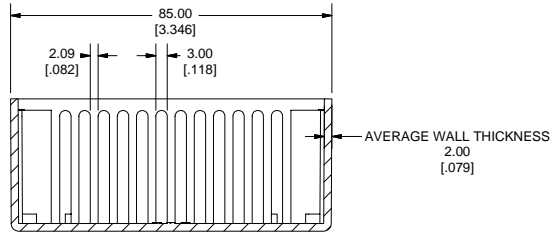

SECTION A-A

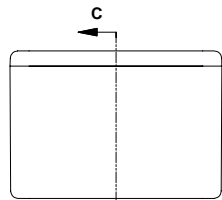

END VIEW OF ASSEMBLY

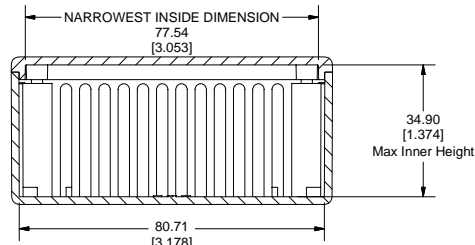

SECTION C-C

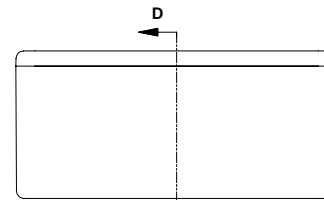

SIDE VIEW OF ASSEMBLY

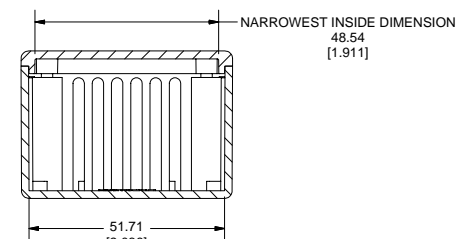

SECTION D-D

LID FASTENERS  
M3 x 10 mm Screws for FRABS/Polycarb  
#4 x 1/2" Self Tapping for GPABS

Brass Inserts in FRABS and Polycarb  
No inserts in GPABS

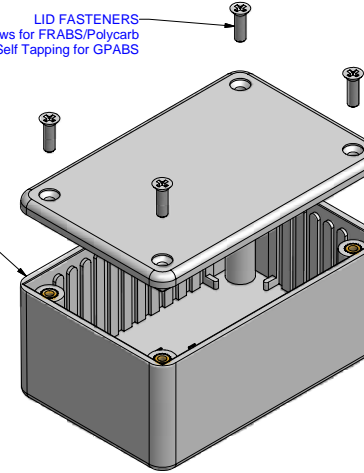

EXPLODED VIEW OF ASSEMBLY

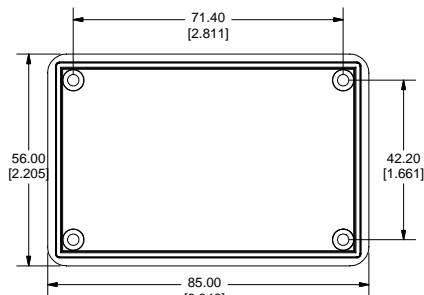

BOTTOM OF LID

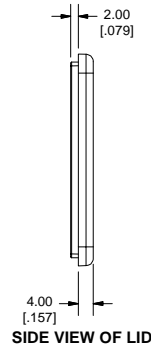

SIDE VIEW OF LID

**Note:**

Enclosures can be Factory Modified ( Milling, Drilling, Printing etc. )  
Solid models of this enclosure available in STEP or IGES Format.  
Contact Factory [mjm@hammondmfg.com](mailto:mjm@hammondmfg.com)



PART NUMBERS		
1591L Enclosures		
Material	Colour	Part Number
FR ABS UL94 - V0	Black	1591LBK
	Grey	1591LGY
	Black Shielded ( Conductive Paint )	1591RLBK
GP ABS	Black	1591LSBK
	Grey	1591LSGY
Translucent Polycarbonate	Ice Blue	1591LTBU
	IR Red	1591LTRD
	Crystal Clear	1591LTCL
Accessories		
	Description	Part Number
Universal Application	PC Board Card Adapters	See Accessories Section
	Flange Kits	See Accessories Section
	Clear Lids - clear, flame retardant polycarbonate - Lid ONLY	1591LC
FR ABS & Polycarbonate	Replacement Screws, Flat head Phillips, Nickel Plated Pkg of 100	1591MS100 1591MS100BK (Black)
GP ABS	Self Tapping Pkg of 100	1591TS100 1591TS100BK ( Black)
Required Torque on Fasteners (no lubrication)		
	M3 - 0.5 x 10mm Screws	30-40 cN*m
	#4 x 0.5 Screws	30-40 cN*m