

Data sheet | Item number: 222-415

Compact splicing connector; 5-conductor terminal block; with operating levers; max. continuous service temperature 85°C

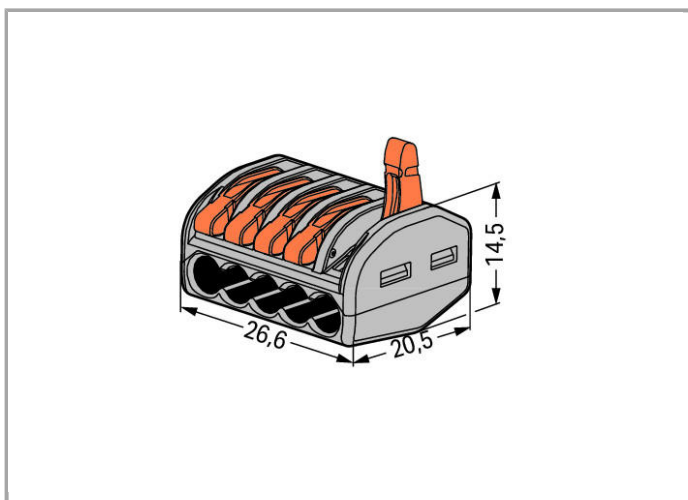

www.wago.com/222-415



Data

Electrical data

Ratings per IEC/EN 60664-1

Rated voltage (II / 2)	400 V
Rated impulse voltage (II / 2)	4 kV



Rated current	32 A
Legend (ratings)	(II / 2) \triangleq Overvoltage category II / Pollution degree 2

Connection data

Connection technology	CAGE CLAMP®
Actuation type	Lever
Connectable conductor materials	Copper Aluminum
Solid conductor	0.08 ... 2.5 mm ² / 28 ... 12 AWG
Stranded conductor	0.08 ... 2.5 mm ² / 28 ... 12 AWG
Fine-stranded conductor	0.08 ... 4 mm ² / 28 ... 12 AWG
Strip length	9 ... 10 mm / 0.35 ... 0.39 Inch
Total number of connection points	5
Total number of potentials	1
Type of wiring	Side-entry wiring

Geometrical Data

Width	26.6 mm / 1.047 inch
Height	14.5 mm / 0.571 inch
Depth	20.5 mm / 0.807 inch

Material Data

Color	gray
Flammability class per UL94	V2
Fire load	0.13 MJ
Weight	6.581 g

Environmental Requirements

Surrounding air (operating) temperature	40 °C
---	-------

Commercial data

Country of origin	DE
GTIN	4044918464956
Customs Tariff No.	85369010000
Product Group	7 (Push Wire Conn.)

Approvals / Certificates



Country specific Approvals

Logo	Approval	Certificate name
	ENEC 15	ENEC-01360





UL International Demko A/S

Ship Approvals



Logo	Approval	Certificate name
	ABS American Bureau of Shipping	15-HG1419918-PDA
	LR Lloyds Register	04/20013 (E4)
	LR Lloyds Register	04/20013 (E6)

UL-Approvals

Logo	Approval	Certificate name
	UL UL International Germany GmbH	E69654
	UL Underwriters Laboratories Inc.	E201573

Compatible products

Mounting adapter

	Item no.: 222-500 Mounting carrier; 222 Series; for DIN-35 rail mounting/screw mounting	www.wago.com/222-500
	Item no.: 222-505 Strain relief plate; for mounting carrier; 221 or 222 Series, can be snapped	www.wago.com/222-505
	Item no.: 222-510 Angled DIN-rail adapter; in combination with mounting carrier; 221-500 or 222-500; for DIN-35 rail mounting	www.wago.com/222-510

General accessories

	Item no.: 249-130 Syringe; Contents: 20 ml Alu-Plus contact paste	www.wago.com/249-130
--	---	--



Downloads

Documentation

Bid Text

222-415	Mar 9, 2018	DOC	Download
Reihenklennen, Verbindungsklemmen		25.6 kB	

smartDATA

CAD data

3D Download 222-415		URL	Download
---------------------	--	-----	----------

Subject to changes.