

Instrument - Polystyrene (1598 Series)

Plastic

Molded in P.C. card standoffs and vertical card guides...

Positive fit, tongue & groove construction requires only two mounting screws...

Complete with four rubber feet and hardware...

Two models available, one with easy to modify ABS black plastic or the other with strong aluminum end panels...

OTHER KEY FEATURES

- Modern low profile designed instrument enclosure.
- Two sets of vertical 1.5 mm (0.062") P.C. board guides are molded into case halves, front and rear.
- Molded from economical grey polystyrene.
- Easy access to interior via shell type construction.
- Designed to meet IP54.
- Integral horizontal P.C. card mounts on Eurocard centers.

ACCESSORIES



Replacement Screws

Self-tapping type, used in polystyrene 1598 series (ie...no brass inserts). # 4 x 5/8" (15.9 mm)
1598TS100 - Package of 100



Belt or Pocket Clip

Molded from tough grey nylon, includes 2 nylon screws and mounting template. **1599CLIPGY**



Replacement Plastic End Panels (Black)

Molded from black fire retardant ABS plastic. Part contains both front & back panel.

- 1598PLABK** - Use with 1598A
- 1598PLBBK** - Use with 1598B
- 1598PLBBBK** - Use with 1598BB
- 1598PLCBK** - Use with 1598C
- 1598PLDBK** - Use with 1598D
- 1598PLEBK** - Use with 1598E
- 1598PLFBK** - Use with 1598F
- 1598PLGBK** - Use with 1598G
- 1598PLHBK** - Use with 1598H
- 1598PLJBK** - Use with 1598J



P.C. Board Screws

Self-tapping type, used for bosses in the 1598 series for P.C. board installation. # 6 x 1/4" (6.4 mm)
1598ATS100 - Package of 100

Instrument - Polystyrene (1598 Series)

Plastic

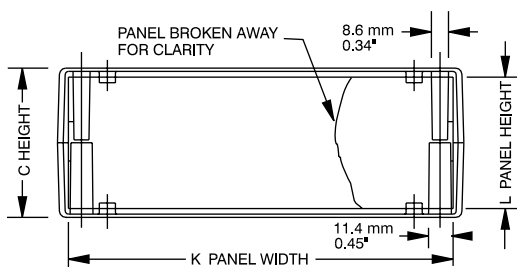
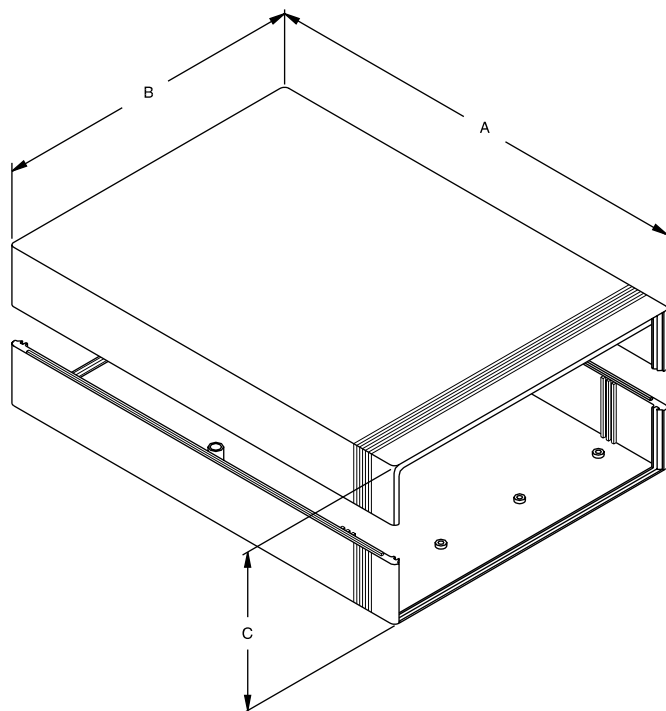

End View

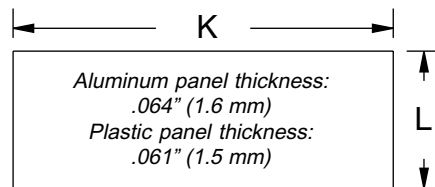

Front or Rear Panel

Part Number		Units	Dimensions			Panel Size	
Grey enclosure with metal panels	Grey enclosure with black plastic panels		A	B	C	K	L
1598BSGY	1598BSGYPBK	inch mm	5.28 134	5.31 135	1.96 50	5.04 128	1.77 45
1598ASGY	1598ASGYPBK	inch mm	6.18 157	3.70 94	1.42 36	3.39 86	1.06 27
1598ESGY	1598ESGYPBK	inch mm	6.30 160	6.30 160	3.38 86	5.98 152	3.11 79
1598BBSGY	1598BBSGYPBK	inch mm	7.05 179	6.06 154	1.42 36	5.75 146	1.14 29
1598CSGY	1598CSGYPBK	inch mm	7.09 180	6.10 155	2.04 52	5.71 145	1.81 46
1598DSGY	1598DSGYPBK	inch mm	7.09 180	8.11 206	2.52 64	7.80 198	2.28 58
1598FSGY	1598FSGYPBK	inch mm	9.84 250	6.30 160	1.58 40	5.98 152	1.38 35
1598GSGY	1598GSGYPBK	inch mm	9.84 250	6.30 160	3.00 76	5.98 152	2.72 69
1598HSGY	1598HSGYPBK	inch mm	11.02 280	7.87 200	1.58 40	7.56 192	1.38 35
1598JSGY	1598JSGYPBK	inch mm	11.02 280	7.87 200	3.00 76	7.56 192	2.72 69

NOTES: - Average top & bottom wall thickness: 0.125" (3.2 mm)
 - Average side wall thickness: 0.18" (4.5 mm)



Hammond Manufacturing Co. Ltd.
 394 Edinburgh Rd. North
 Guelph, Ontario N1H 1E5 CANADA
 © Phone: 519-822-2960 Fax: 519-822-0715



Hammond Manufacturing Co. Inc.
 256 Sonwil Dr.
 Cheektowaga, NY 14225 USA
 Phone: 716-651-0086 Fax: 716-651-0726

1598 Series Drawings

Plastic

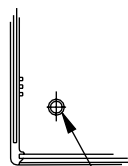
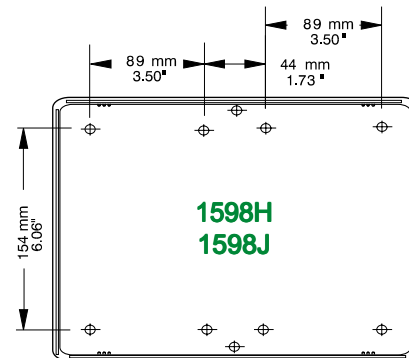
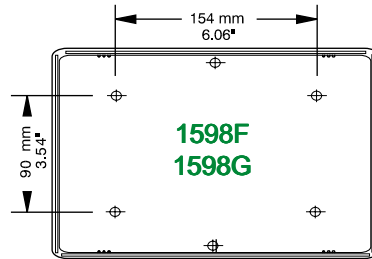
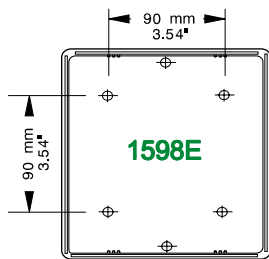
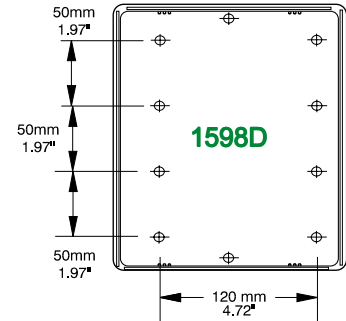
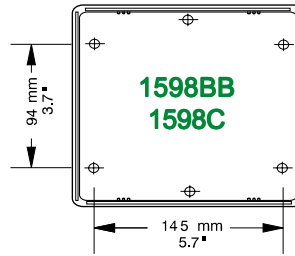
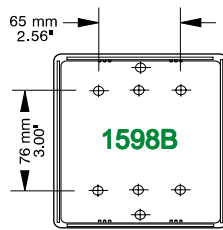
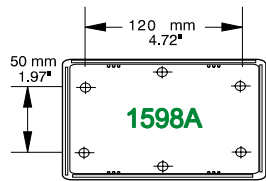

POST 3 mm I/S .12" I/S
8 mm DIA O/S .32" DIA O/S

P.C. Board Standoff Detail

For detailed drawings, CAD files and color photos visit our website at:
www.hammondmfg.com

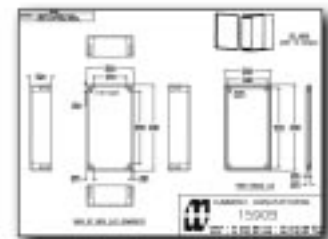
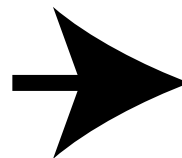

NOTES

MATERIAL: -ABS UL94 V0 WITH BRASS INSERTS & M3 SCREWS,
 -STYRENE SELF TAPPING SCREWS,
 -AVAILABLE IN BLACK & GRAY

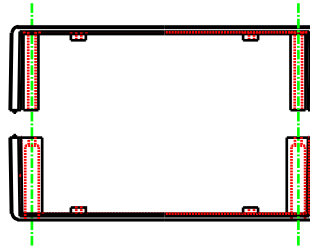
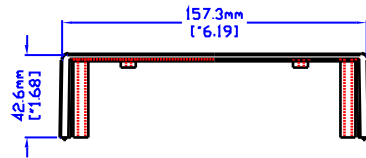

CASE 'A' & 'B'

3D VIEW
 (NOT TO SCALE)

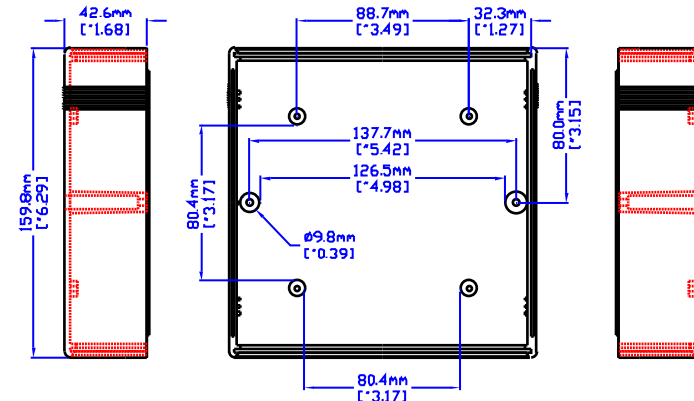
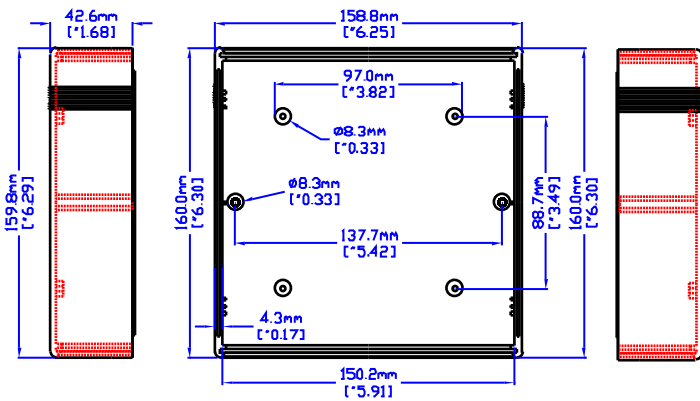
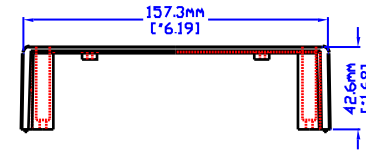
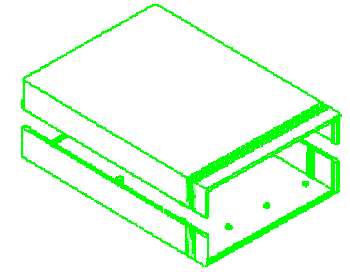

HIDDEN LINE INDICATES THE AREA COVERED BY ENCLOSURE SLOT

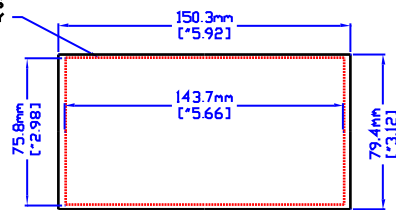

CASE 'A'



CASE 'B'

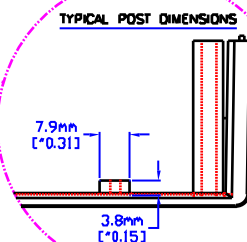

HAMMOND MANUFACTURING

1598E

CANADA - PH (519) 886 7170 - FAX (519) 886 8311
 U.S.A. - PH (716) 631 5700 - FAX (716) 631 1156