

Hand Held Instrument (1593 Series)

Plastic

Version A

Recessed top for membrane display or pad...

Four P.C. card standoffs molded in bottom...



Removable front & rear panels for easy modification (or replace with optional IR panel) - sized to accept most popular connectors...

Version B

Recessed top for membrane display or pad...

Four P.C. card standoffs molded in both halves...

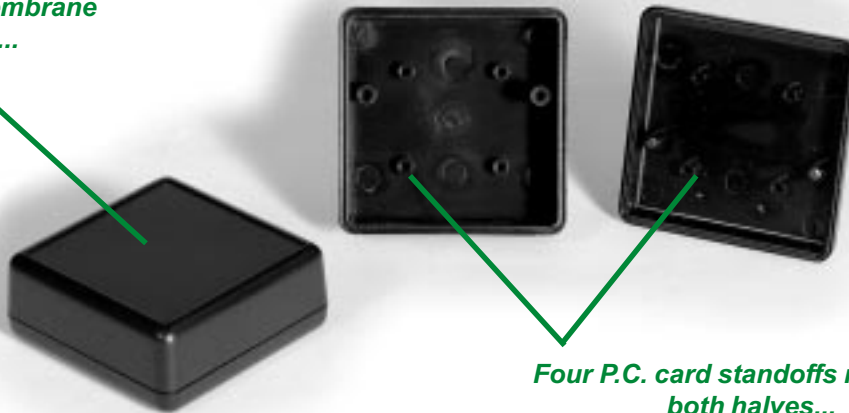

Version C

Recessed top for membrane display or pad...

Four vertical P.C. card guides molded in...

Long life battery door with our "three snap" location door...

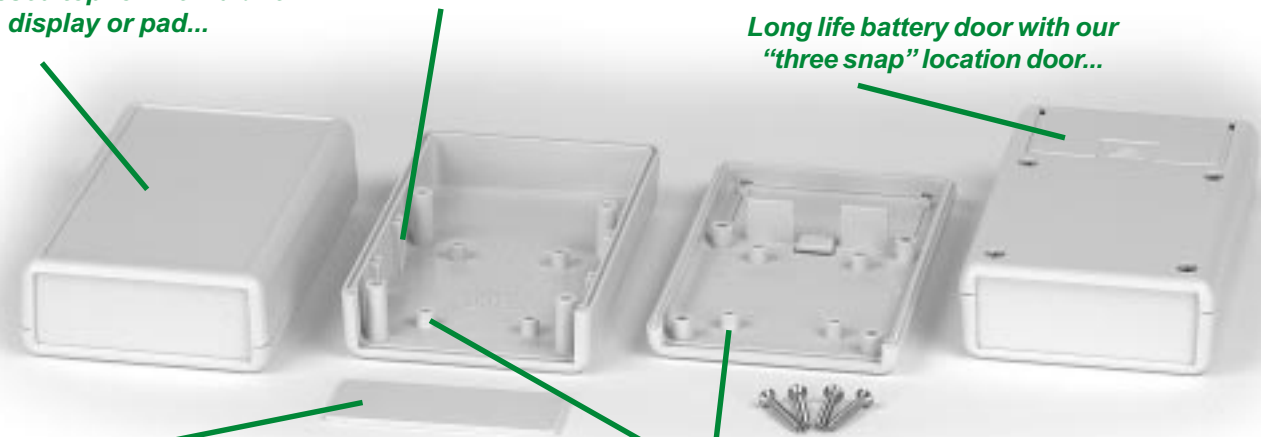

Removable front panel (or replace with optional IR panel) for easy modification - sized to accept most popular connectors...

P.C. card standoffs molded in both halves...

Hand Held Instrument (1593 Series)

KEY FEATURES

- Electronic instrument enclosures, ideally suited for mounting printed circuit boards.
- Accessory screws for mounting P.C. boards into standoffs P/N **1593ATS50** (qty. 50), P/N **1593ATS100** (qty. 100).
- Ergonomically designed for a comfortable fit into the user's hand.
- Two piece lap joint construction provides protection against dust accumulation and splashing water.
- Molded from a choice of black or grey general purpose ABS plastic.
- Unit is secured with self-tapping screws.

Plastic

Part Number		Units	Dimensions			Battery Compartment	Front Open (w/panel)	Rear Open (w/panel)	Reference Version
Black	Grey		A	B	C				
1593KBK	1593KGY	inch mm	2.6 66	2.6 66	1.1 28	N	Y	Y	A
1593JBK	1593JGY	inch mm	2.6 66	2.6 66	1.1 28	N	N	N	B
1593SBK	1593SGY	inch mm	3.6 92	2.6 66	.83 21	Y*	Y	N	C
1593PBK	1593PGY	inch mm	3.6 92	2.6 66	1.1 28	Y	Y	N	C
1593TBK	1593TGY	inch mm	4.4 112	2.6 66	.83 21	Y*	Y	N	C
1593QBK	1593QGY	inch mm	4.4 112	2.6 66	1.1 28	Y	Y	N	C
1593DBK	1593DGY	inch mm	4.5 114	1.4 36	1.0 25	N	Y	Y	A
1593YBK	1593YGY	inch mm	5.5 140	2.6 66	1.1 28	Y	Y	N	C
1593XBK	1593XGY	inch mm	5.5 140	2.6 66	1.1 28	N	Y	Y	A

NOTES: * Due to their low profile design, the 1593S & 1593T models will not accept batteries larger than AAA.

Version A

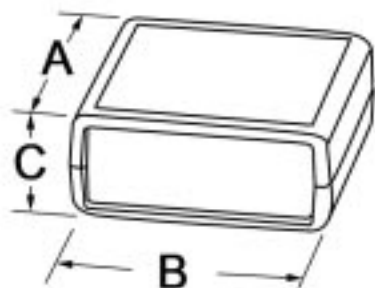

Version B

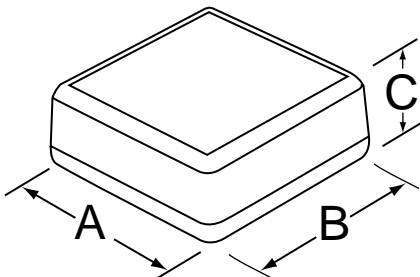

Version C

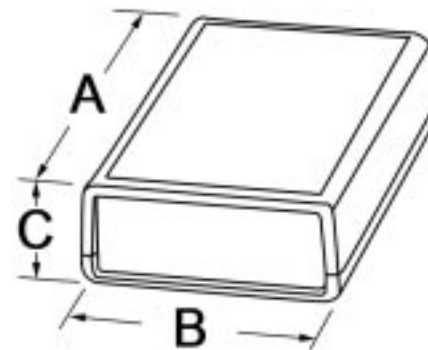

ACCESSORIES

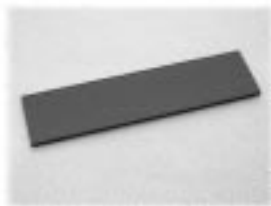

Optional Infrared Panel

Sold in packages of 10

1593DIR10 for 1593D

1593PIR10 for 1593J, K, P, Q, Y & X

1593SIR10 for 1593S & T



Belt or Pocket Clip

Molded from tough nylon, includes 2 nylon screws and mounting template.

Black - **1599CLIP**

Grey - **1599CLIPGY**



Replacement Screws

Self-tapping, oval head type, #4 x 0.625" (15.9 mm)

1593MS100 - Package of 100



Hammond Manufacturing Co. Ltd.
394 Edinburgh Rd. North
Guelph, Ontario N1H 1E5 CANADA
© Phone: 519-822-2960 Fax: 519-822-0715



Hammond Manufacturing Co. Inc.
256 Sonwil Dr.
Cheektowaga, NY 14225 USA
Phone: 716-651-0086 Fax: 716-651-0726

NOTES

- MATERIAL** MOLDED USING GENERAL PURPOSE ABS PLASTIC
- PARTS** COMES WITH SELF TAPPING, OVAL HEAD TYPE, #4 X 0.625" SCREWS, REPLACEMENT PART NUMBER 1593MS100 - PACKAGE OF 100. COMES WITH 2 FLAT AND 2 BEVELED END PANELS.
- COLOR** CHOICE OF BLACK OR GRAY,

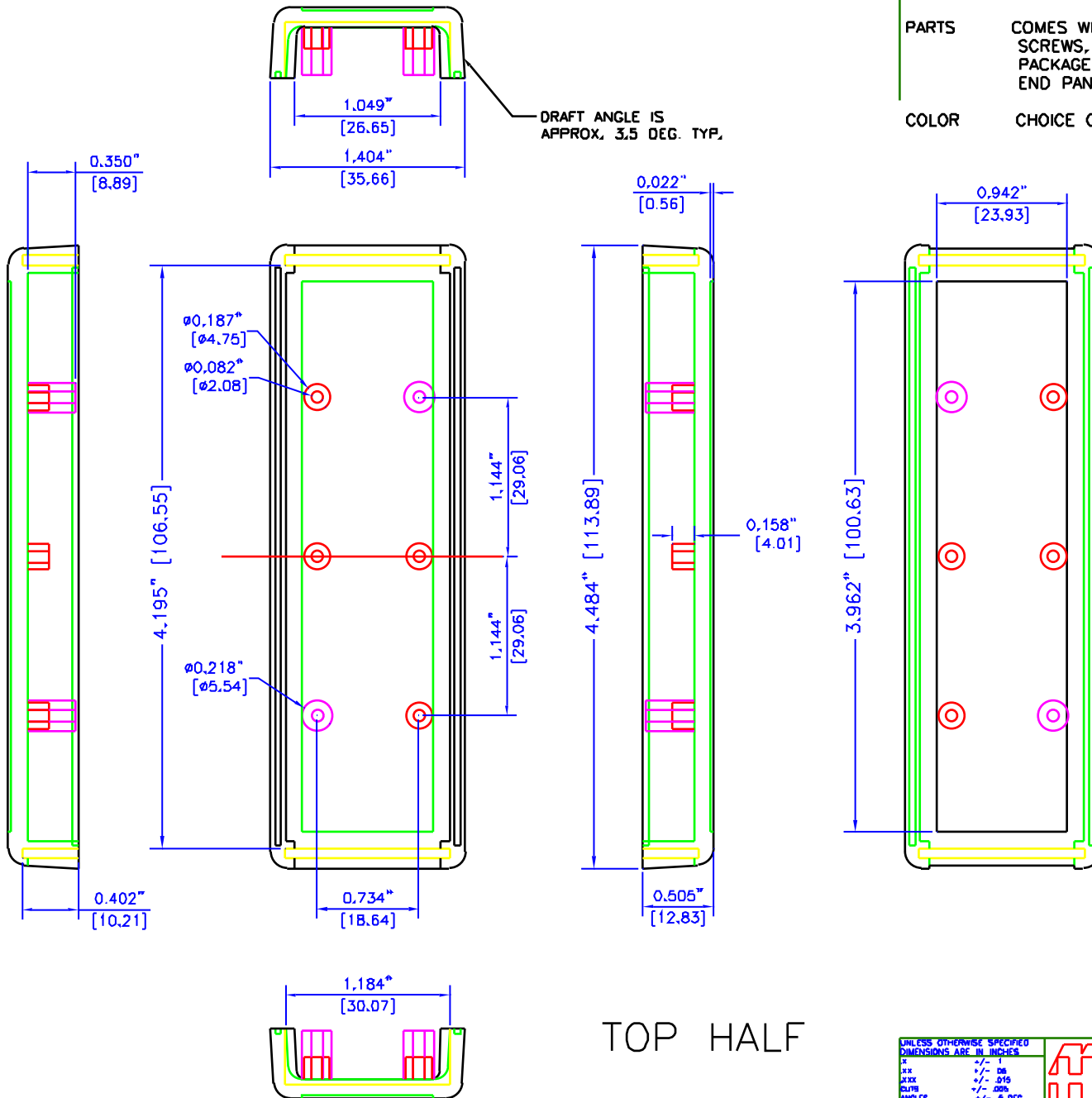

FLAT END PANEL

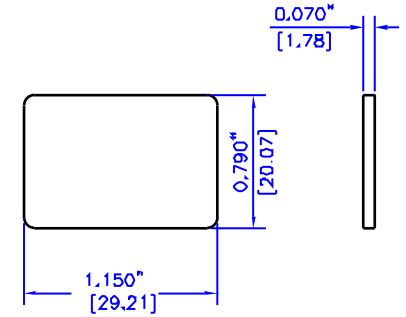

BEVELED END PANEL

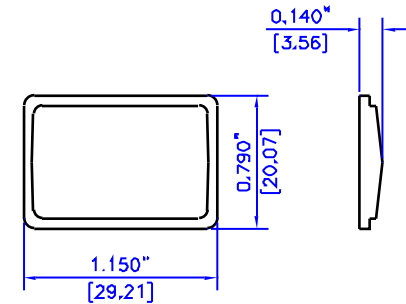

TOP HALF

UNLESS OTHERWISE SPECIFIED
DIMENSIONS ARE IN INCHES

XX	+/- .1
XXX	+/- .05
XXXX	+/- .015
ANGLES	+/- .5 DEG.

NOTES
1. UNLESS OTHERWISE SPECIFIED, ALL DIMENSIONS ARE TO BE TAKEN TO THE CENTERLINE OF THE PART UNLESS OTHERWISE SPECIFIED.
2. DIMENSIONS TO BE TAKEN TO THE CENTERLINE OF THE PART UNLESS OTHERWISE SPECIFIED.
3. DIMENSIONS TO BE TAKEN TO THE CENTERLINE OF THE PART UNLESS OTHERWISE SPECIFIED.
4. DIMENSIONS TO BE TAKEN TO THE CENTERLINE OF THE PART UNLESS OTHERWISE SPECIFIED.
5. DIMENSIONS TO BE TAKEN TO THE CENTERLINE OF THE PART UNLESS OTHERWISE SPECIFIED.



**HAMMOND
MANUFACTURING**

WEB: WWW.HAMMONDMFG.COM

TITLE		HAMMOND 1593 SERIES INSTRUMENT ENCLOSURE	
DRAWN BY	MJM	DATE	01/27/01
SCALE		PAGE	1 OF 2
PART NUMBER	1593D		

NOTES

- MATERIAL** MOLDED USING GENERAL PURPOSE ABS PLASTIC
- PARTS** COMES WITH SELF TAPPING, OVAL HEAD TYPE, #4 X 0.625" SCREWS. REPLACEMENT PART NUMBER 1593MS100 - PACKAGE OF 100, COMES WITH 2 FLAT AND 2 BEVELED END PANELS.
- COLOR** CHOICE OF BLACK OR GRAY,

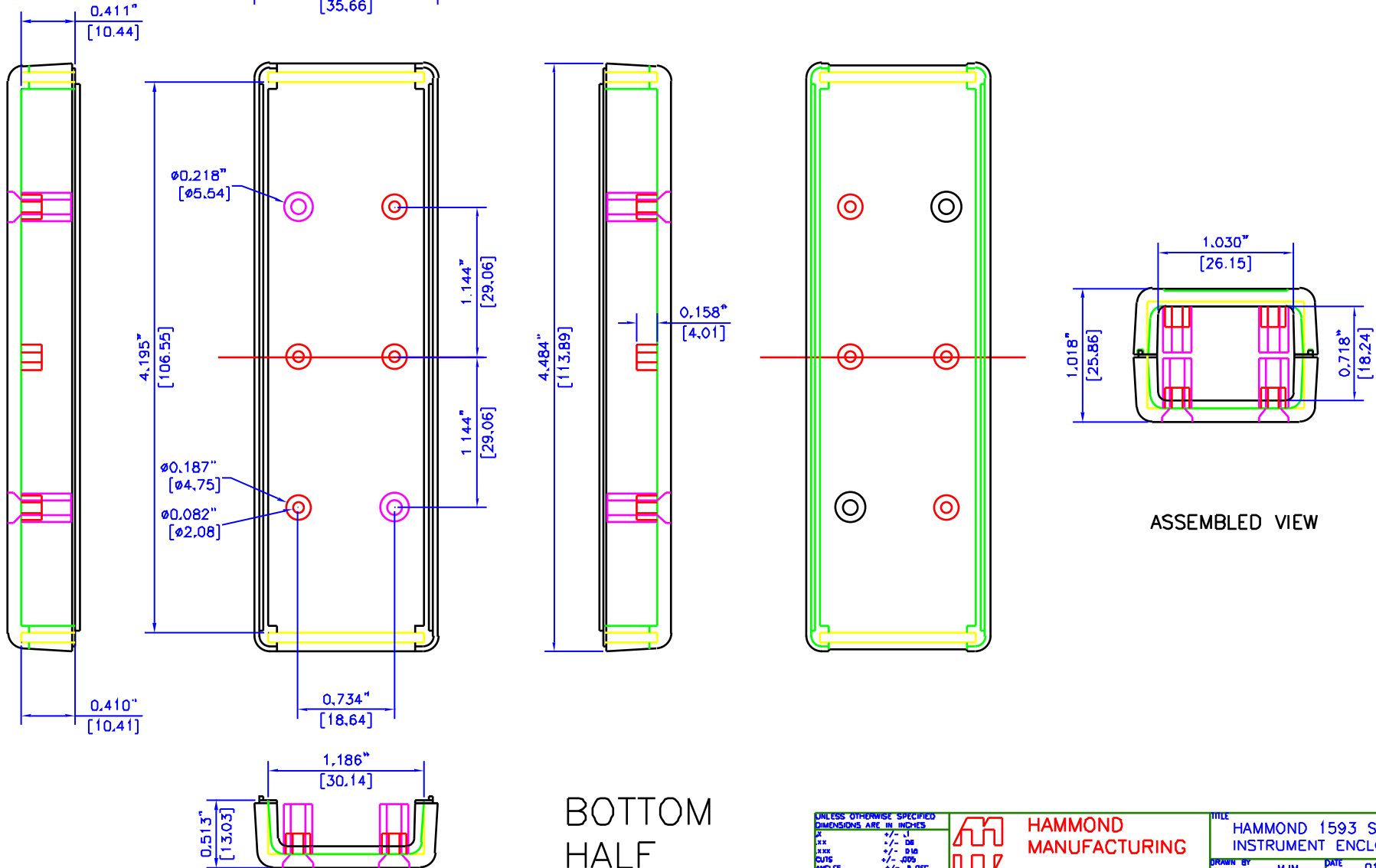
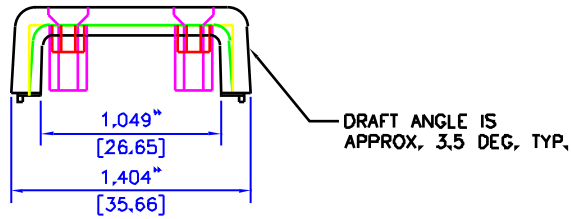

ASSEMBLED VIEW

BOTTOM HALF

UNLESS OTHERWISE SPECIFIED DIMENSIONS ARE IN INCHES
 XX +/- .1
 XXX +/- .05
 CUTS +/- .005
 ANGLES +/- .5 DEG
 FINISHES
 UNLESS OTHERWISE SPECIFIED REFER TO THE MATERIAL OR HAS OTHERWISE IT IS INTENDED TO BE USED AS A REFERENCE FOR ENGINEERING INFORMATION ONLY. THIS INFORMATION MAY NOT BE USED TO MANUFACTURE PRODUCT WITHOUT WRITTEN PERMISSION FROM HAMMOND MANUFACTURING.



WEB: WWW.HAMMONDMFG.COM

TITLE		HAMMOND 1593 SERIES INSTRUMENT ENCLOSURE	
DRAWN BY	MJM	DATE	01/27/01
SCALE		PAGE	2 OF 2
PART NUMBER		1593D	