

Data sheet | Item number: 243-308

MICRO PUSH WIRE® connector for junction boxes; 8-conductor terminal block

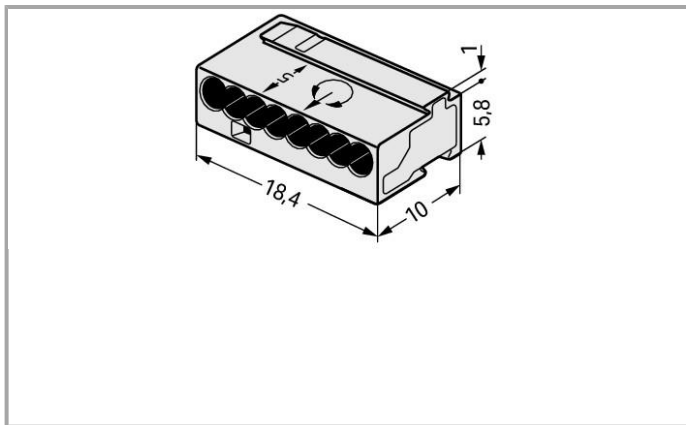

[www.wago.com/243-308](http://www.wago.com/243-308)

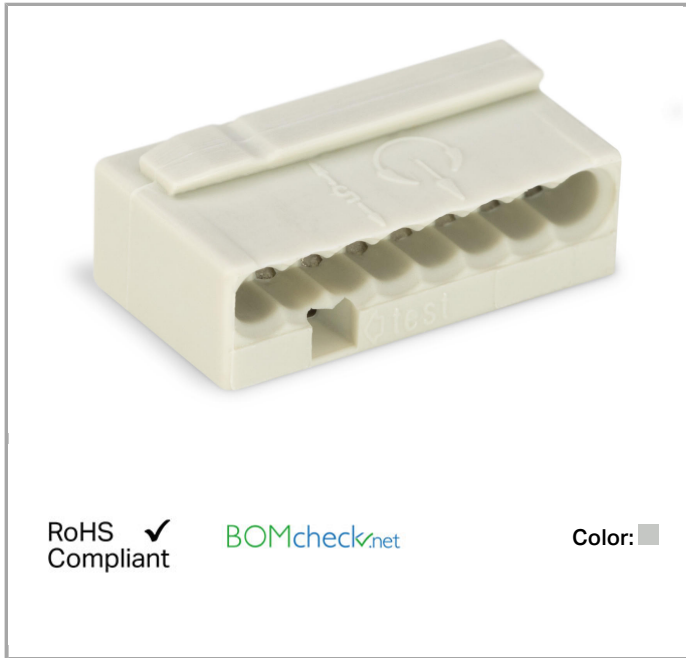

#### Data

#### Electrical data

#### Ratings per IEC/EN 60664-1

Rated voltage (II / 2)	100 V
Rated impulse voltage (II / 2)	1.5 kV
Rated current	6 A
Legend (ratings)	(II / 2) ≙ Overvoltage category II / Pollution degree 2

## Connection data

Connection technology	PUSH WIRE®
Actuation type	Push-in
Connectable conductor materials	Copper
Conductor diameter	0.6 ... 0.8 mm / ... AWG
Strip length	5 ... 6 mm / 0.2 ... 0.24 Inch
Total number of connection points	8
Total number of potentials	1
Number of connection types	1
Number of levels	1
Type of wiring	Side-entry wiring

## Geometrical Data

Width	18.4 mm / 0.724 inch
Height	6.8 mm / 0.268 inch
Depth	10 mm / 0.394 inch

## Material Data

Color	light gray
Fire load	0.019 MJ
Weight	1.44 g

## Environmental Requirements

Surrounding air (operating) temperature	60 °C
---	-------

## Commercial data

Country of origin	DE
GTIN	4044918502689
Customs Tariff No.	85369010000

## Approvals / Certificates

### Country specific Approvals

Logo	Approval	Certificate name
	CCA DEKRA Certification B.V.	NTR NL 7486
	CSA DEKRA Certification B.V.	70048857



CSA  
DEKRA Certification B.V.

70048857



KEMA/KEUR  
DEKRA Certification B.V.

2193300.01

#### Ship Approvals

Logo	Approval	Certificate name
	<b>ABS</b> American Bureau of Shipping	15-HG1419918-PDA



LR  
Lloyds Register



04/20013 (E4)

#### UL-Approvals

Logo	Approval	Certificate name
	<b>UR</b> Underwriters Laboratories Inc.	E45172

#### Compatible products

##### General accessories

	<b>Item no.: 243-112</b> Mounting carrier; for 4 connectors; 243 Series; for DIN-35 rail mounting/screw mounting	<a href="http://www.wago.com/243-112">www.wago.com/243-112</a>
	<b>Item no.: 243-113</b> Mounting carrier; for 6 connectors; 243 Series; for DIN-35 rail mounting/screw mounting	<a href="http://www.wago.com/243-113">www.wago.com/243-113</a>
	<b>Item no.: 249-130</b> Syringe; Contents: 20 ml Alu-Plus contact paste	<a href="http://www.wago.com/249-130">www.wago.com/249-130</a>

##### Marking accessories

	<b>Item no.: 210-332/575-103</b> Marking strips; as a DIN A4 sheet; MARKED; 1-12 (160x); Height of marker strip: 3 mm; Strip length 182 mm; Horizontal marking; Self-adhesive	<a href="http://www.wago.com/210-332/575-103">www.wago.com/210-332/575-103</a>
--	--	--



Downloads

Documentation

Bid Text

243-308

Oct 10, 2017

DOC  
25.6 kB

Download

---

Subject to changes.