

CATALOGUE 2007

pcb terminal blocks
interconnection
fuses & fuseholders
batteries
leds
miniature switches
relay bases
interface modules
enclosures
ic & plc sockets
control products

CAMDEN[®]
electronics ltd

Vertretung für Deutschland:

AXXATRONIC GmbH, Alemannenstrasse 10, 71296 Heimsheim

Telefon: (0 70 33) 46 66 1 - 0, Fax: (0 70 33) 46 66 1 - 23, www.axxatronic.de, info@axxatronic.de

DIN Rail Standard Height Module Boxes

Features

- Snap fit kit for easy assembly
- Boxes fit 35mm DIN rail or direct surface mount*
- Self customised perforated terminal covers as standard
- Snap fit terminal covers for IP20 finger protection
- Can carry up to 3 PCB's horizontally and 2/4 vertically
- Grey, transparent red or clear snap-in covers
- Front panel ideal for screen printing logo's etc
- Moulded in grey UL94-V0 flame retardant PC
- Enclosed base eliminates any need for additional insulation
- Optional adaptor for G rail mounting
- Patent pending

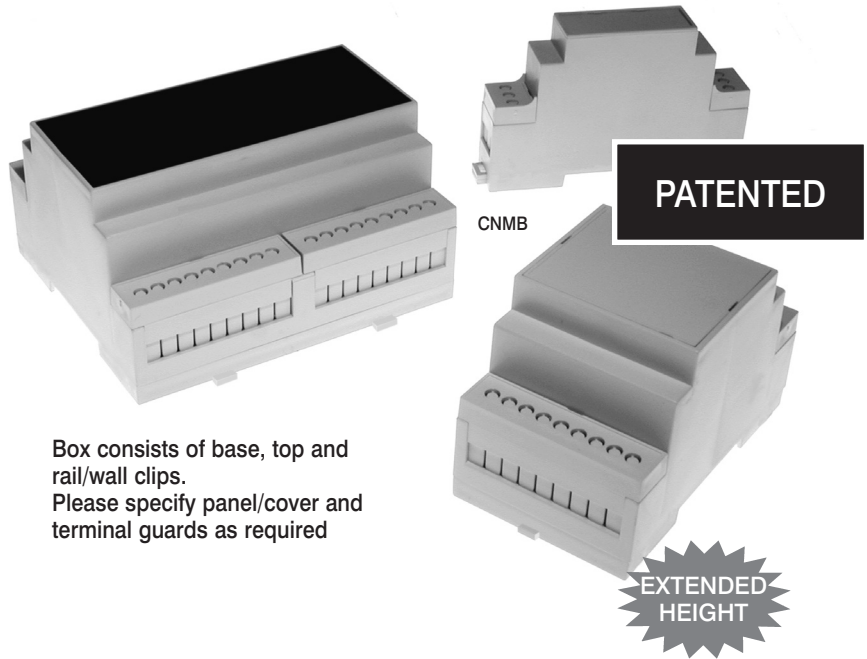

Box consists of base, top and rail/wall clips.
Please specify panel/cover and terminal guards as required

N.B. CNMB/-/2 = terminal access + covers on both sides of box
CNMB/-/1 = terminal access + covers on one side only other side closed

Optional Special Features

- Customised terminal guards
- Alternative black higher rated RTI material
- Other colours including Black, Green and Blue
- EMC shielded metallic coated boxes

Box options

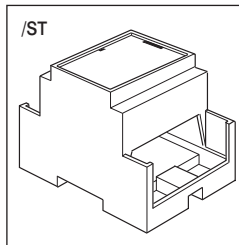

/ST – is a recessed solid top box, usually used for a membrane keypads or with a clear lid to enclose a label
PCB mounting options

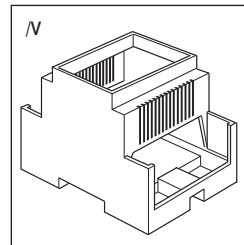

/V – has cooling vents both sides

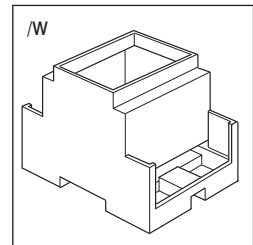

/W – has extended walls which meet the lower PCB behind the usual positions for the PCB terminals

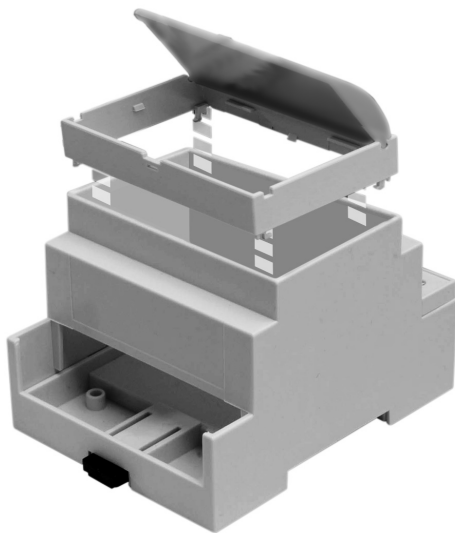
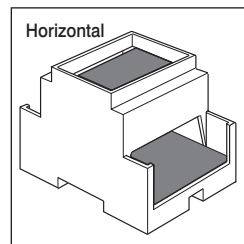
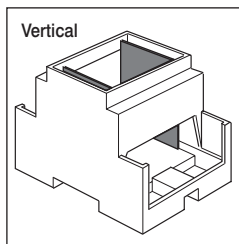

Vertretung für Deutschland:

AXXATRONIC GmbH, Alemannenstrasse 10, 71296 Heimsheim

Telefon: (0 70 33) 46 66 1 - 0, Fax: (0 70 33) 46 66 1 - 23, www.axxatronic.de, info@axxatronic.de

DIN Rail Standard Height Module Boxes

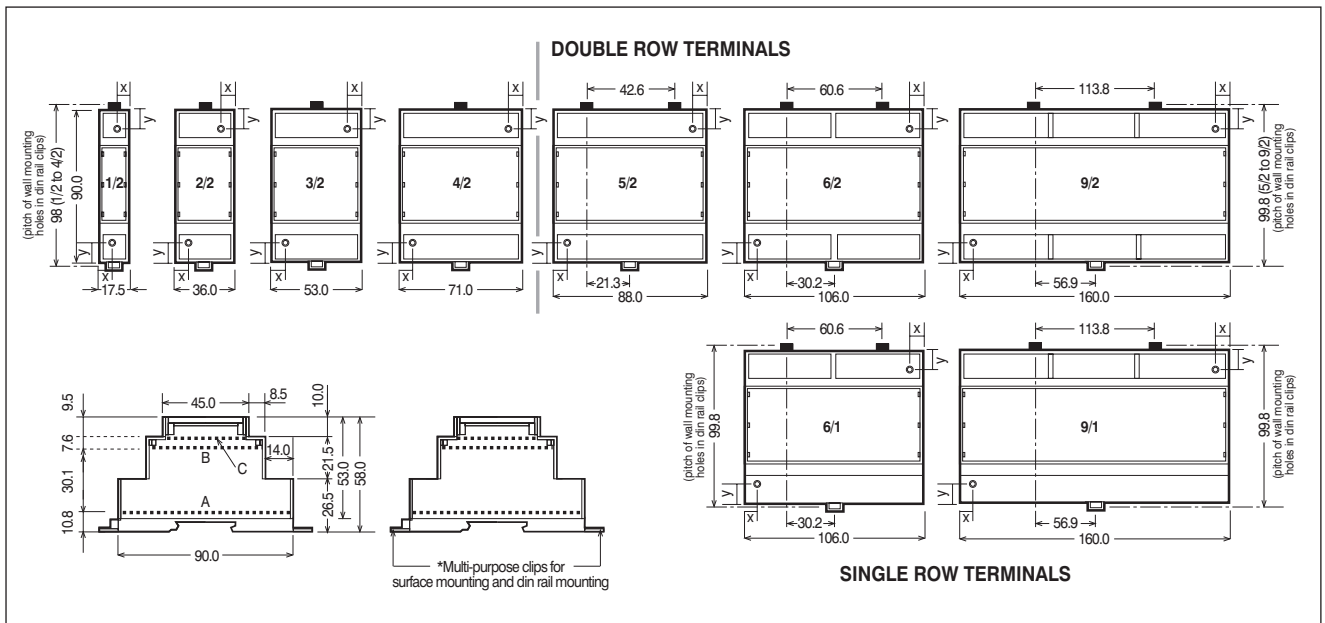

PCB dimensions

Part No	Box size	Box length	A horizontal	B horizontal	C horizontal	E vertical	F vertical
CNMB/1-	1	17.5mm	86.5x14	57x14	41.8x14	34x59.6	40x14.8
CNMB/2-	2	36mm	86.5x33	57x32	42x32	34x59.7	40x33
CNMB/3-	3	53mm	86.5x50	57x49	42x49	34x59.8	40x50
CNMB/4-	4	71mm	86.5x68	57x67	42x67	34x59.9	40x68
CNMB/5-	5	88mm	86.5x84	57x83	42x83	34x59.10	40x84
CNMB/6-	6	106mm	86.5x103	57x102	42x102	34x59.11	40x103
CNMB/9-	9	160mm	86.5x155	57x155.4	42x154	34x59.12	40x155

Fixing boss dimensions

Part No	Box size	x	y
CNMB/1-	1	6.2	18.3
CNMB/2-	2	6.2	18.3
CNMB/3-	3	8.8	18.3
CNMB/4-	4	8.8	18.3
CNMB/5-	5	8.8	18.3
CNMB/6-	6	8.9	18.3
CNMB/9-	9	8.9	18.3

Boss Internal dia = 3mm
Boss External dia = 5mm

There are two mounting bosses on the base of the boxes to allow fixing of the lower pcb if required. This may be useful if the pcb is carrying heavy components e.g. transformers. The bosses are designed to accept 'plastite' type screws.

Din clip hole diameter

The diameter of the hole in the din clip is 4mm +0.0/-0.1

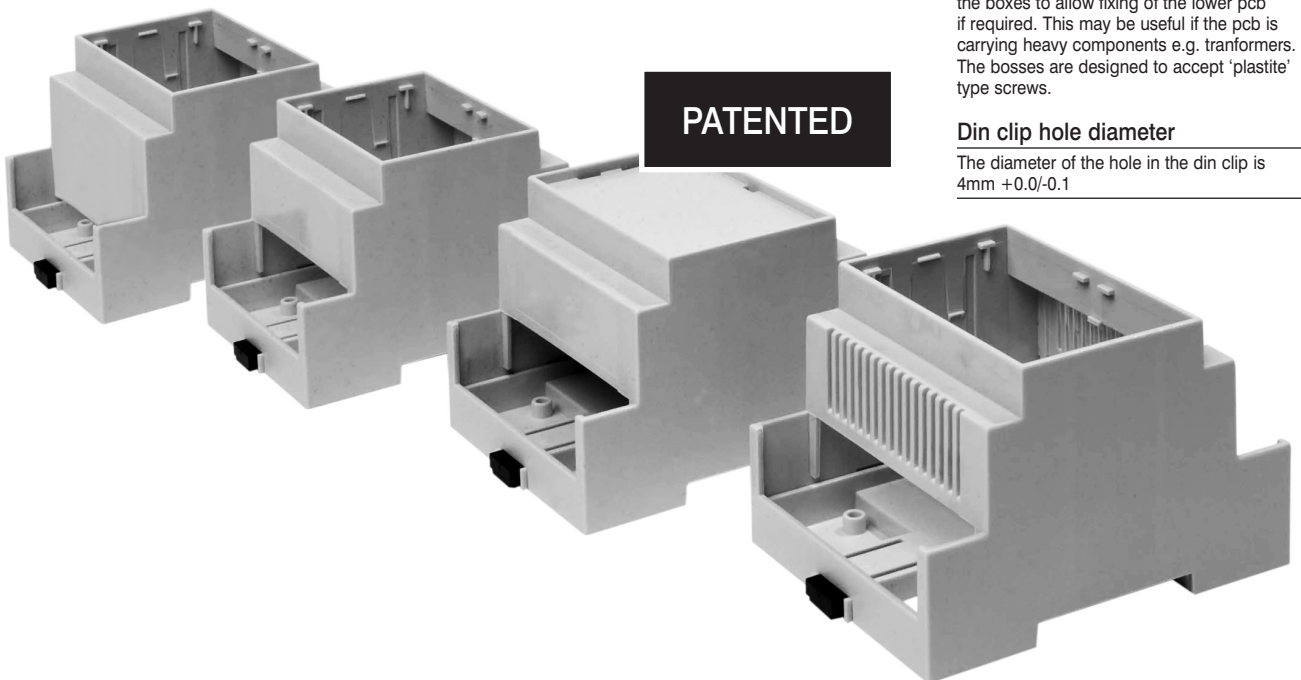

Vertretung für Deutschland:

AXXATRONIC GmbH, Alemannenstrasse 10, 71296 Heimsheim

Telefon: (0 70 33) 46 66 1 - 0, Fax: (0 70 33) 46 66 1 - 23, www.axxatronic.de, info@axxatronic.de

CAMDEN
E L E C T R O N I C S L T D

Terminal Guards

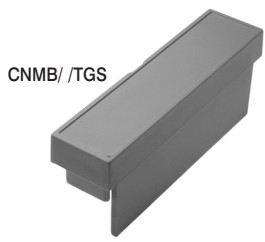

Type No.	
CNMB/1/TGS	Solid
CNMB/2/TGS	Solid
CNMB/3/TGS	Solid
CNMB/4/TGS	Solid
CNMB/5/TGS	Solid

For 6 & 9 size module use
CNMB/3/TGS

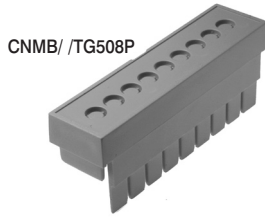
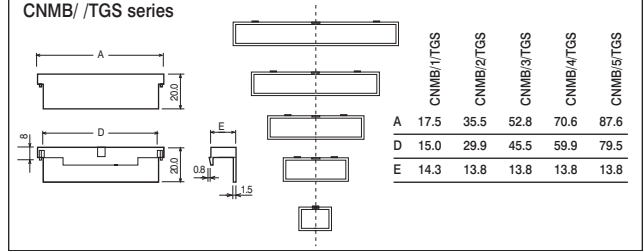

Type No.	Poles
CNMB/1/TG508P	Perforated 3
CNMB/2/TG508P	Perforated 6
CNMB/3/TG508P	Perforated 9
CNMB/4/TG508P	Perforated 12
CNMB/5/TG508P	Perforated 15

For 6 & 9 size module use
CNMB/3/TG508P

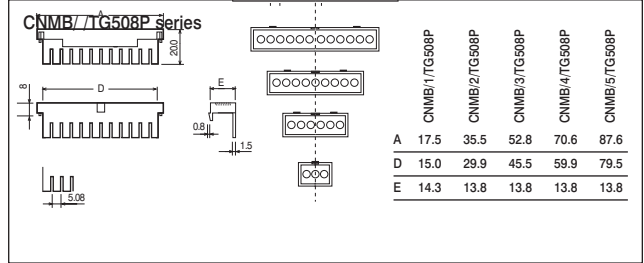

Type No.	Poles
CNMB/1/TG508	Pre-drilled 3
CNMB/2/TG508	Pre-drilled 6
CNMB/3/TG508	Pre-drilled 9
CNMB/4/TG508	Pre-drilled 12
CNMB/5/TG508	Pre-drilled 15

For 6 & 9 size module use
CNMB/3/TG508

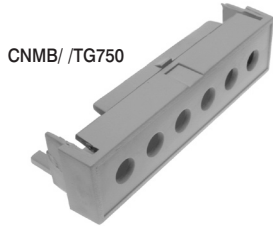
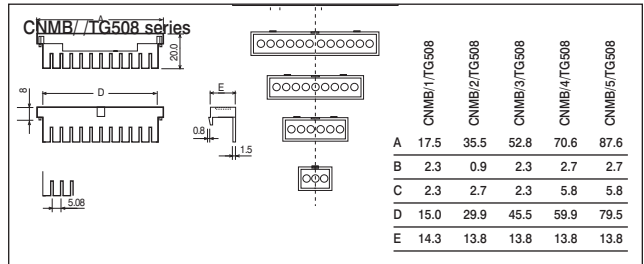

Type No.	Poles
CNMB/1/TG750	Pre-drilled 2
CNMB/2/TG750	Pre-drilled 4
CNMB/3/TG750	Pre-drilled 6
CNMB/4/TG750	Pre-drilled 8
CNMB/5/TG750	Pre-drilled 10

For 6 & 9 size module use
CNMB/3/TG750

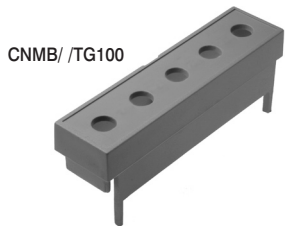
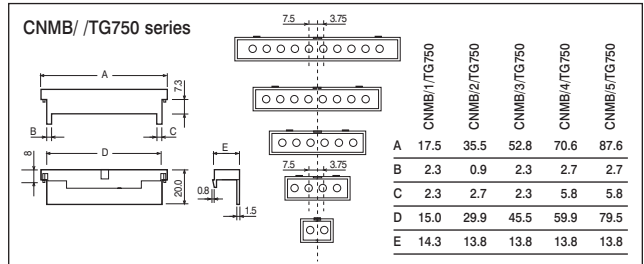

Type No.	Poles
CNMB/1/TG100	Pre-drilled 2
CNMB/2/TG100	Pre-drilled 3
CNMB/3/TG100	Pre-drilled 5
CNMB/4/TG100	Pre-drilled 6
CNMB/5/TG100	Pre-drilled 7

For 6 & 9 size module use
CNMB/3/TG100

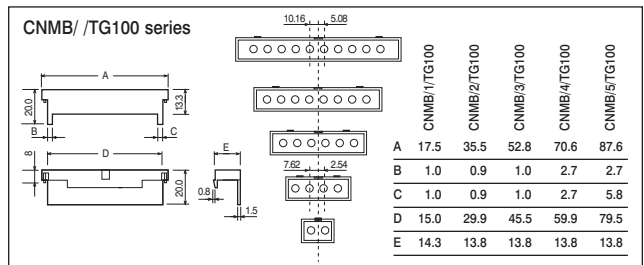

Vertretung für Deutschland:



AXXATRONIC GmbH, Alemannenstrasse 10, 71296 Heimsheim

Telefon: (0 70 33) 46 66 1 - 0, Fax: (0 70 33) 46 66 1 - 23, www.axxatronic.de, info@axxatronic.de

Extended Height module

Features

- 16mm high
- Accepts hinged, curved lid
- Can house an additional horizontal pcb

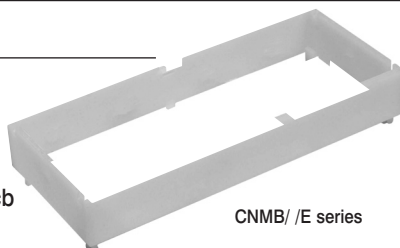

CNMB/ /E series

Type No.	Description	Width
CNMB/2/E	Extended height module	34.7mm
CNMB/3/E	Extended height module	52.0mm
CNMB/4/E	Extended height module	70.0mm
CNMB/5/E	Extended height module	86.5mm
CNMB/6/E	Extended height module	104.5mm
CNMB/9/E	Extended height module	157.7mm

Panel/Covers

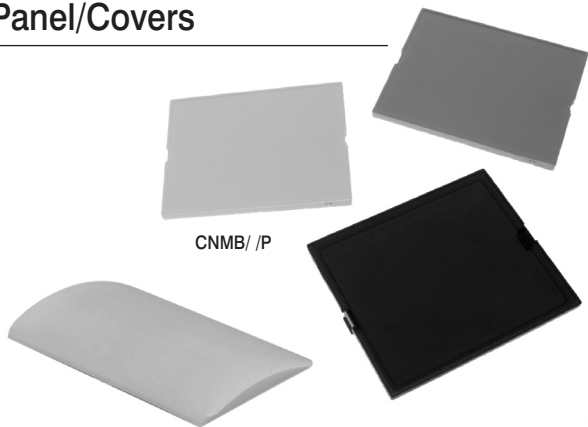

CNMB/ /P

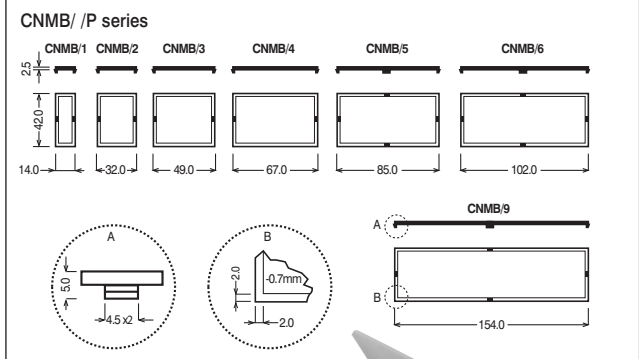

Type No.	Clip on covers
CNMB/1/PR	Red transparent
CNMB/2/PR	Red transparent
CNMB/3/PR	Red transparent
CNMB/4/PR	Red transparent
CNMB/5/PR	Red transparent
CNMB/6/PR	Red transparent
CNMB/9/PR	Red transparent
CNMB/1/PRC	Red transparent curved
CNMB/2/PRC	Red transparent curved
CNMB/3/PRC	Red transparent curved
CNMB/4/PRC	Red transparent curved
CNMB/5/PRC	Red transparent curved
CNMB/6/PRC	Red transparent curved
CNMB/9/PRC	Red transparent curved
CNMB/1/PC	Clear transparent
CNMB/2/PC	Clear transparent
CNMB/3/PC	Clear transparent
CNMB/4/PC	Clear transparent
CNMB/5/PC	Clear transparent
CNMB/6/PC	Clear transparent
CNMB/9/PC	Clear transparent
CNMB/1/PCC	Clear transparent curved
CNMB/2/PCC	Clear transparent curved
CNMB/3/PCC	Clear transparent curved
CNMB/4/PCC	Clear transparent curved
CNMB/5/PCC	Clear transparent curved
CNMB/6/PCC	Clear transparent curved
CNMB/9/PCC	Clear transparent curved

The above fit the standard height boxes

Type No.	Clip on covers
CNMB/1/PS	Smoked transparent
CNMB/2/PS	Smoked transparent
CNMB/3/PS	Smoked transparent
CNMB/4/PS	Smoked transparent
CNMB/5/PS	Smoked transparent
CNMB/6/PS	Smoked transparent
CNMB/9/PS	Smoked transparent
CNMB/1/PSC	Smoked transparent curved
CNMB/2/PSC	Smoked transparent curved
CNMB/3/PSC	Smoked transparent curved
CNMB/4/PSC	Smoked transparent curved
CNMB/5/PSC	Smoked transparent curved
CNMB/6/PSC	Smoked transparent curved
CNMB/9/PSC	Smoked transparent curved
CNMB/1/PG	Grey
CNMB/2/PG	Grey
CNMB/3/PG	Grey
CNMB/4/PG	Grey
CNMB/5/PG	Grey
CNMB/6/PG	Grey
CNMB/9/PG	Grey
CNMB/1/PGC	Grey curved
CNMB/2/PGC	Grey curved
CNMB/3/PGC	Grey curved
CNMB/4/PGC	Grey curved
CNMB/5/PGC	Grey curved
CNMB/6/PGC	Grey curved
CNMB/9/PGC	Grey curved

The above fit the standard height boxes

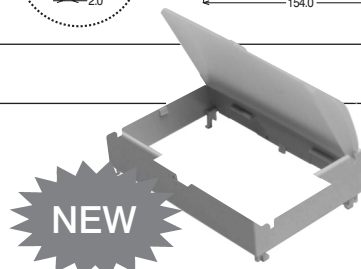

NEW

Hinged covers on extended only

Type No.	Description
CNMB/2/HPCC	Hinged clear curved
CNMB/3/HPCC	Hinged clear curved
CNMB/4/HPCC	Hinged clear curved
CNMB/5/HPCC	Hinged clear curved
CNMB/6/HPCC	Hinged clear curved
CNMB/9/HPCC	Hinged clear curved
CNMB/2/HPRC	Hinged transparent red curved
CNMB/3/HPRC	Hinged transparent red curved
CNMB/4/HPRC	Hinged transparent red curved
CNMB/5/HPRC	Hinged transparent red curved
CNMB/6/HPRC	Hinged transparent red curved
CNMB/9/HPRC	Hinged transparent red curved
CNMB/2/HPGC	Hinged grey curved
CNMB/3/HPGC	Hinged grey curved
CNMB/4/HPGC	Hinged grey curved
CNMB/5/HPGC	Hinged grey curved
CNMB/6/HPGC	Hinged grey curved
CNMB/9/HPGC	Hinged grey curved

Kits available from our distributors
 Kits consist of base, top panel, terminal , and clips for rail or wall mounting. Each kit includes 2 perforated terminal covers enabling customisation as required. CNMB/6/kit & CNMB/9/kit are supplied with additional blank terminal guards.

Vertretung für Deutschland:

AXXATRONIC GmbH, Alemannenstrasse 10, 71296 Heimsheim

Telefon: (0 70 33) 46 66 1 - 0, Fax: (0 70 33) 46 66 1 - 23, www.axxatronic.de, info@axxatronic.de



E L E C T R O N I C S L T D

Panel/Covers

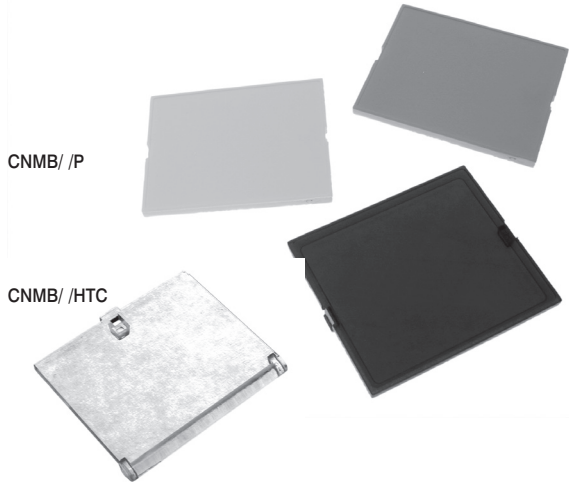

CNMB/ /P series

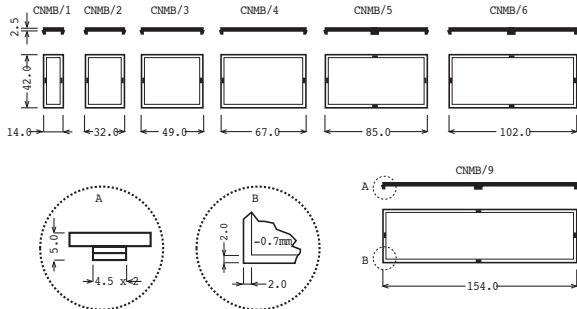

Type No.

CNMB/1/PR	Red transparent cover
CNMB/2/PR	Red transparent cover
CNMB/3/PR	Red transparent cover
CNMB/4/PR	Red transparent cover
CNMB/5/PR	Red transparent cover
CNMB/6/PR	Red transparent cover
CNMB/9/PR	Red transparent cover
CNMB/1/PC	Clear transparent cover
CNMB/2/PC	Clear transparent cover
CNMB/3/PC	Clear transparent cover
CNMB/4/PC	Clear transparent cover
CNMB/5/PC	Clear transparent cover
CNMB/6/PC	Clear transparent cover
CNMB/9/PC	Clear transparent cover
CNMB/1/PS	Smoked transparent cover
CNMB/2/PS	Smoked transparent cover
CNMB/3/PS	Smoked transparent cover
CNMB/4/PS	Smoked transparent cover
CNMB/5/PS	Smoked transparent cover
CNMB/6/PS	Smoked transparent cover
CNMB/9/PS	Smoked transparent cover
CNMB/1/PG	Grey cover
CNMB/2/PG	Grey cover
CNMB/3/PG	Grey cover
CNMB/4/PG	Grey cover
CNMB/5/PG	Grey cover
CNMB/6/PG	Grey cover
CNMB/9/PG	Grey cover