

Product Description

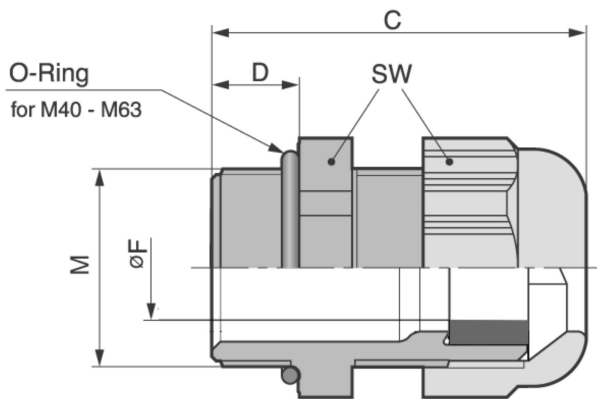

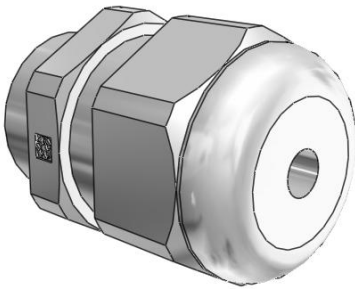

**Technical Data**

ATN	53111120
M	M 20x1,5
FMIN	5
FMAX	10
F	5
SW	25
A	27.6
C	37
D	9
RAL7001	X
RAL7035	
RAL9005	
MATERIAL	Kunststoff