

Product Description

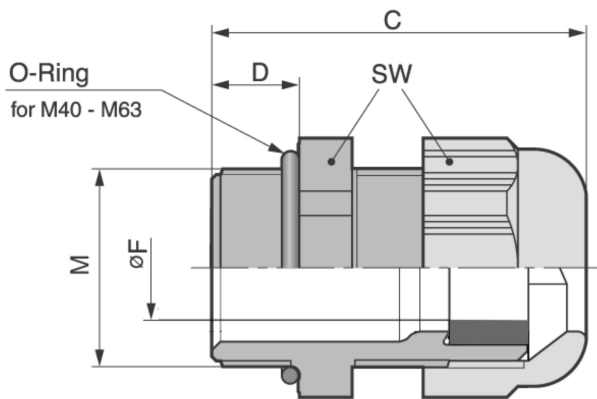

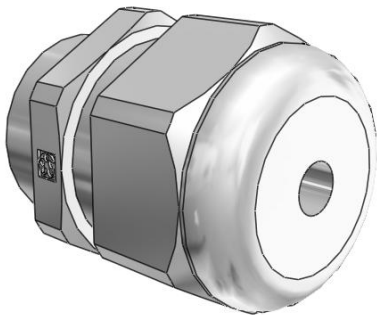

**Technical Data**

ATN	53111330
M	M 25x1,5
FMIN	6
FMAX	13
F	6
SW	30
A	33.4
C	40
D	10
RAL7001	
RAL7035	
RAL9005	X
MATERIAL	Kunststoff