

DIN Rail Module Boxes

Features

- Snap fit kit for easy assembly
- Boxes fit 35mm DIN rail or direct surface mount
- Self customised perforated terminal covers as standard
- Snap fit terminal covers for IP20 finger protection
- Can carry up to 3 PCB's horizontally and 2/4 vertically
- Grey, transparent red or clear snap-in covers
- Front panel ideal for screen printing logo's etc
- Moulded in grey UL94-V0 flame retardant PC
- Enclosed base eliminates any need for additional insulation
- Optional adaptor for G rail mounting

PATENTED

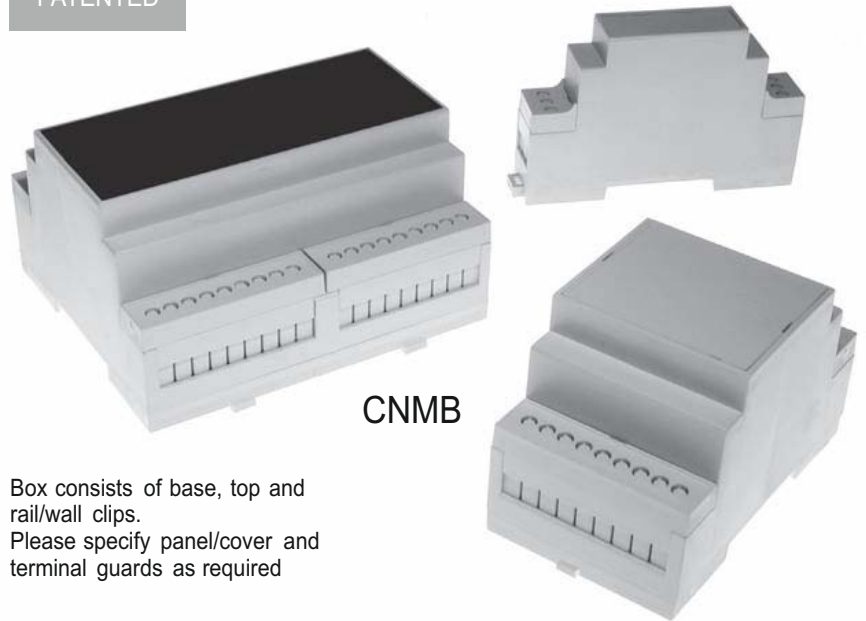

CNMB

Box consists of base, top and rail/wall clips.
Please specify panel/cover and terminal guards as required

N.B. CNMB/-2 = terminal access + covers on both sides of box
CNMB/-1 = terminal access + covers on one side only other side closed

Optional Special Features

- Customised terminal guards
- Alternative black higher rated RTI material
- Other colours including Black, Green and Blue
- EMC shielded metallic coated boxes

Box options

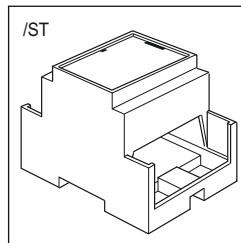

/ST – is a recessed solid top box, usually used for a membrane keypads or with a clear lid to enclose a label

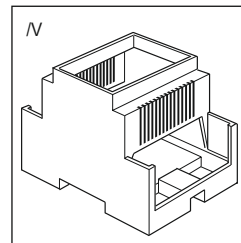

/V – has cooling vents both sides

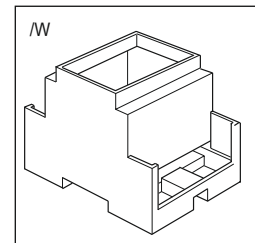

/W – has extended walls which meet the lower pcb behind the usual positions for the pcb terminals

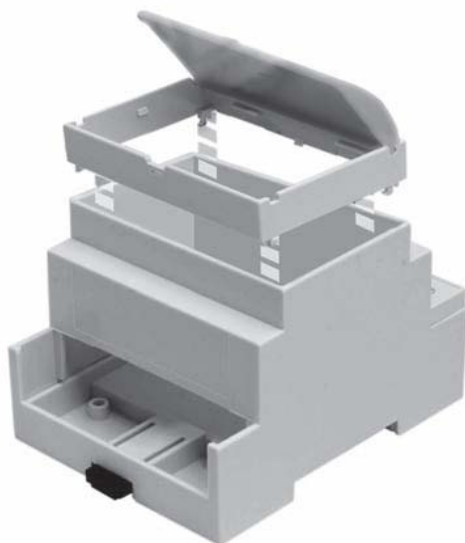

PCB mounting options

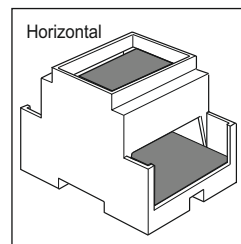
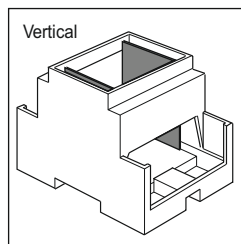

Ansprechpartner für Deutschland:

AXXATRONIC GmbH, Alemannenstrasse 10, 71296 Heimsheim

Telefon: (0 70 33) 46 66 1 - 0, Fax: (0 70 33) 46 66 1 - 23, www.axxatronic.de, info@axxatronic.de



FM28614
BS EN ISO
9001:
2000

DIN Rail Module Boxes

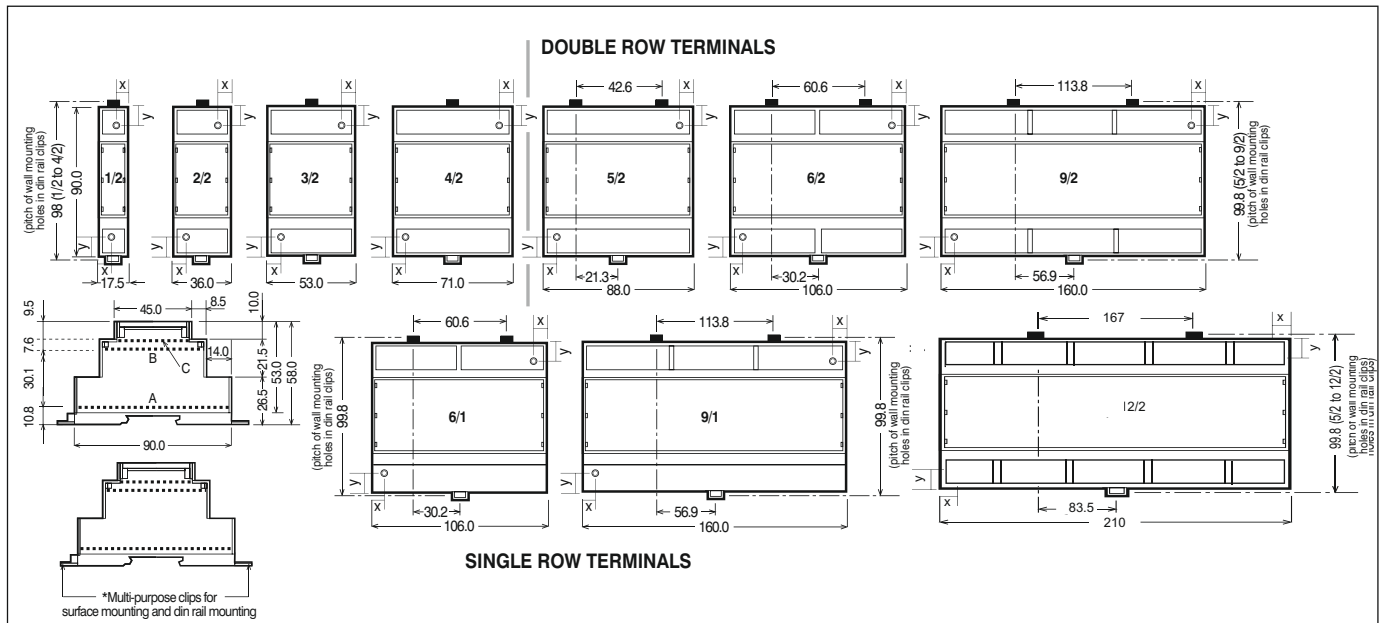

PCB dimensions

Part No	Box size	Box length	A horizontal	B horizontal	C horizontal	E vertical	F vertical
CNMB/1-	1	17.5 mm	86.5x14	57x14	41.8x14	34x59.6	40x14.8
CNMB/2-	2	36 mm	86.5x33	57x32	42x32	34x59.7	40x33
CNMB/3-	3	53 mm	86.5x50	57x49	42x49	34x59.8	40x50
CNMB/4-	4	71 mm	86.5x68	57x67	42x67	34x59.9	40x68
CNMB/5-	5	88 mm	86.5x84	57x83	42x83	34x59.10	40x84
CNMB/6-	6	106 mm	86.5x103	57x102	42x102	34x59.11	40x103
CNMB/9-	9	160 mm	86.5x155	57x155.4	42x154	34x59.12	40x155
CNMB/12-	12	210 mm	86.5x207.5	57x207	42x207	34x59.6	40x207.5

Fixing boss dimensions

Part No	Box size	x	y
CNMB/1-	1	6.2	18.3
CNMB/2-	2	6.2	18.3
CNMB/3-	3	8.8	18.3
CNMB/4-	4	8.8	18.3
CNMB/5-	5	8.8	18.3
CNMB/6-	6	8.9	18.3
CNMB/9-	9	8.9	18.3
CNMB/12-	12	8.9	18.3

Boss Internal dia = 3mm
Boss External dia = 5mm

There are two mounting bosses on the base of the boxes to allow fixing of the lower pcb if required. This may be useful if the pcb is carrying heavy components e.g. transformers. The bosses are designed to accept 'plastite' type screws.

Din clip hole diameter

The diameter of the hole in the din clip is 4mm +0.0/-0.1

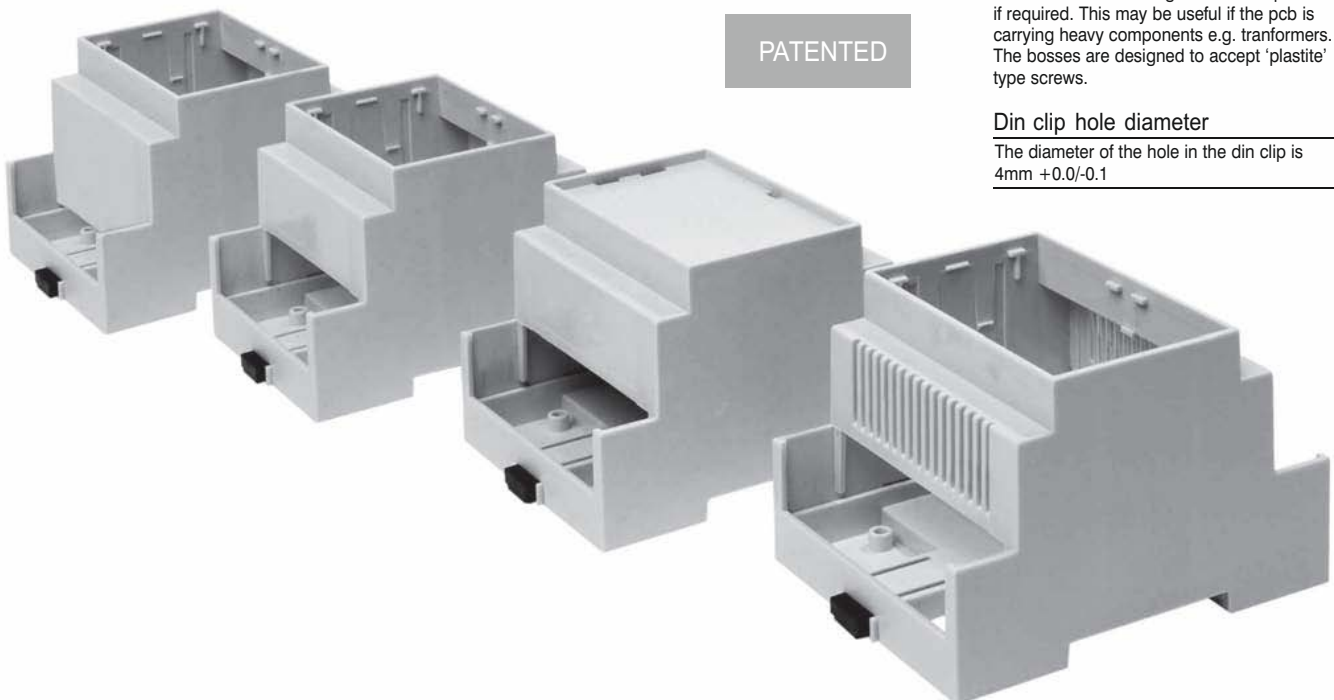

Ansprechpartner für Deutschland:

AXXATRONIC GmbH, Alemannenstrasse 10, 71296 Heimsheim

Telefon: (0 70 33) 46 66 1 - 0, Fax: (0 70 33) 46 66 1 - 23, www.axxatronic.de, info@axxatronic.de



FM28614
BS EN ISO
9001:
2000

Terminal Guards

CNMB/ /TGS



Type No.	
CNMB/1/TGS	Solid
CNMB/2/TGS	Solid
CNMB/3/TGS	Solid
CNMB/4/TGS	Solid
CNMB/5/TGS	Solid

For 6, 9 & 12 size module use
CNMB/3/TGS

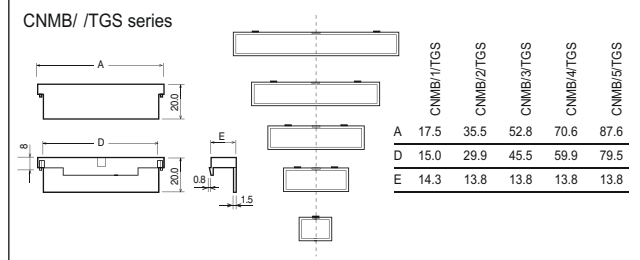

CNMB/ /TG508P



Type No.	Poles
CNMB/1/TG508P	Perforated 3
CNMB/2/TG508P	Perforated 6
CNMB/3/TG508P	Perforated 9
CNMB/4/TG508P	Perforated 12
CNMB/5/TG508P	Perforated 15

For 6, 9 & 12 size module use
CNMB/3/TG508P

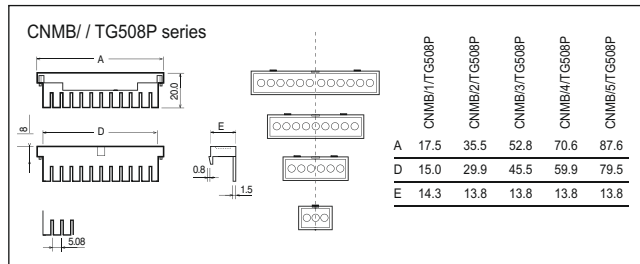

CNMB/ /TG508



Type No.	Poles
CNMB/1/TG508	Pre-drilled 3
CNMB/2/TG508	Pre-drilled 6
CNMB/3/TG508	Pre-drilled 9
CNMB/4/TG508	Pre-drilled 12
CNMB/5/TG508	Pre-drilled 15

For 6, 9 & 12 size module use
CNMB/3/TG508

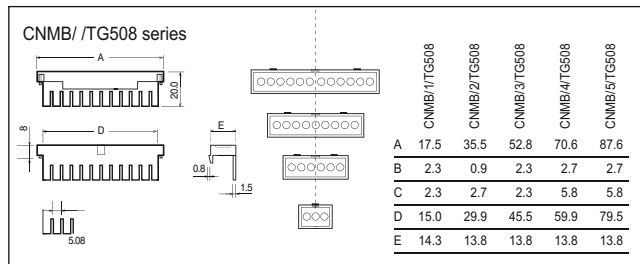

CNMB/ /TG750



Type No.	Poles
CNMB/1/TG750	Pre-drilled 2
CNMB/2/TG750	Pre-drilled 4
CNMB/3/TG750	Pre-drilled 6
CNMB/4/TG750	Pre-drilled 8
CNMB/5/TG750	Pre-drilled 10

For 6, 9 & 12 size module use
CNMB/3/TG750

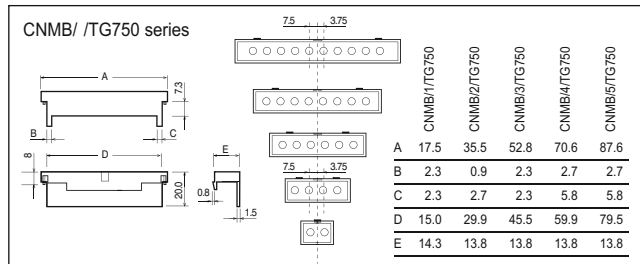

CNMB/ /TG100

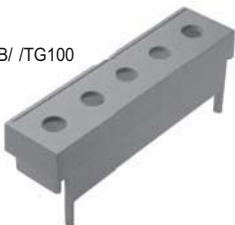

Type No.	Poles
CNMB/1/TG100	Pre-drilled 2
CNMB/2/TG100	Pre-drilled 3
CNMB/3/TG100	Pre-drilled 5
CNMB/4/TG100	Pre-drilled 6
CNMB/5/TG100	Pre-drilled 7

For 6, 9 & 12 size module use
CNMB/3/TG100

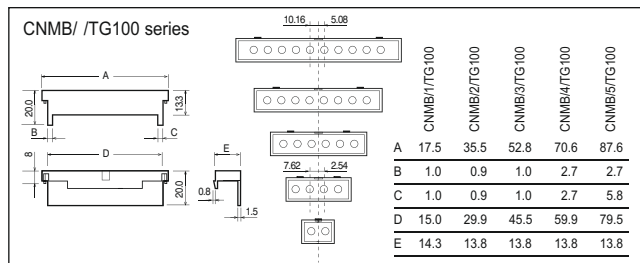

Ansprechpartner für Deutschland:

AXXATRONIC GmbH, Alemannenstrasse 10, 71296 Heimsheim

Telefon: (0 70 33) 46 66 1 - 0, Fax: (0 70 33) 46 66 1 - 23, www.axxatronic.de, info@axxatronic.de



FM28614
BS EN ISO
9001:
2000

ENCLOSURES

Extended Height module

Features

- 16mm high
- Accepts hinged, curved lid only
- Can house an additional horizontal pcb



Type No.	Description	Width
CNMB/2/E	Extended height module	34.7 mm
CNMB/3/E	Extended height module	52.0 mm
CNMB/4/E	Extended height module	70.0 mm
CNMB/5/E	Extended height module	86.5 mm
CNMB/6/E	Extended height module	104.5 mm
CNMB/9/E	Extended height module	157.7 mm

Panel/Covers

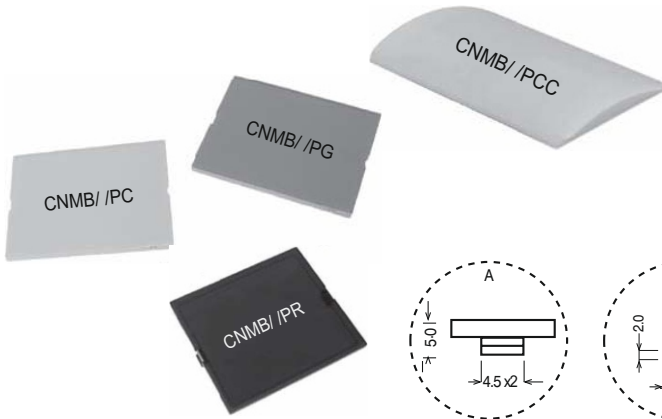

CNMB/ /P series

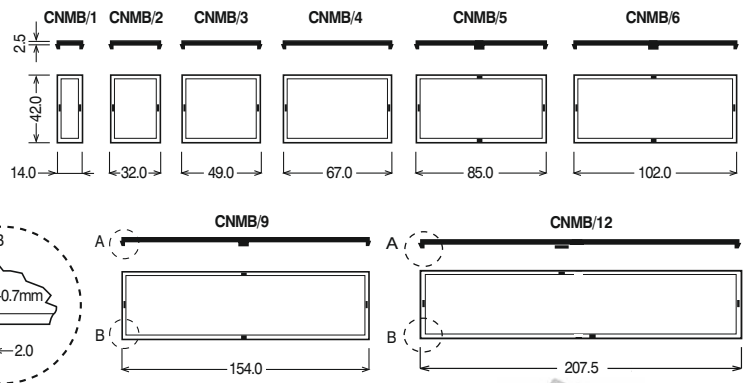

Type No.	Clip on covers
CNMB/1/PR	Red transparent
CNMB/2/PR	Red transparent
CNMB/3/PR	Red transparent
CNMB/4/PR	Red transparent
CNMB/5/PR	Red transparent
CNMB/6/PR	Red transparent
CNMB/9/PR	Red transparent
CNMB/1/PRC	Red transparent curved
CNMB/2/PRC	Red transparent curved
CNMB/3/PRC	Red transparent curved
CNMB/4/PRC	Red transparent curved
CNMB/5/PRC	Red transparent curved
CNMB/6/PRC	Red transparent curved
CNMB/9/PRC	Red transparent curved
CNMB/1/PC	Clear transparent
CNMB/2/PC	Clear transparent
CNMB/3/PC	Clear transparent
CNMB/4/PC	Clear transparent
CNMB/5/PC	Clear transparent
CNMB/6/PC	Clear transparent
CNMB/9/PC	Clear transparent
CNMB/9/PC	Clear transparent
CNMB/12/PC	Clear transparent
CNMB/2/PCC	Clear transparent curved
CNMB/3/PCC	Clear transparent curved
CNMB/4/PCC	Clear transparent curved
CNMB/5/PCC	Clear transparent curved
CNMB/6/PCC	Clear transparent curved
CNMB/9/PCC	Clear transparent curved

The above fit the standard height boxes

Type No.	Clip on covers
CNMB/1/PS	Smoked transparent
CNMB/2/PS	Smoked transparent
CNMB/3/PS	Smoked transparent
CNMB/4/PS	Smoked transparent
CNMB/5/PS	Smoked transparent
CNMB/6/PS	Smoked transparent
CNMB/9/PS	Smoked transparent
CNMB/1/PSC	Smoked transparent curved
CNMB/2/PSC	Smoked transparent curved
CNMB/3/PSC	Smoked transparent curved
CNMB/4/PSC	Smoked transparent curved
CNMB/5/PSC	Smoked transparent curved
CNMB/6/PSC	Smoked transparent curved
CNMB/9/PSC	Smoked transparent curved
CNMB/1/PG	Grey
CNMB/2/PG	Grey
CNMB/3/PG	Grey
CNMB/4/PG	Grey
CNMB/5/PG	Grey
CNMB/6/PG	Grey
CNMB/9/PG	Grey
CNMB/12/PG	Grey
CNMB/1/PGC	Grey curved
CNMB/2/PGC	Grey curved
CNMB/3/PGC	Grey curved
CNMB/4/PGC	Grey curved
CNMB/5/PGC	Grey curved
CNMB/6/PGC	Grey curved
CNMB/9/PGC	Grey curved

The above fit the standard height boxes

Type No.	Hinged covers on extended only
CNMB/2/HPCC	Hinged clear curved
CNMB/3/HPCC	Hinged clear curved
CNMB/4/HPCC	Hinged clear curved
CNMB/5/HPCC	Hinged clear curved
CNMB/6/HPCC	Hinged clear curved
CNMB/9/HPCC	Hinged clear curved
CNMB/2/HPRC	Hinged transparent red curved
CNMB/3/HPRC	Hinged transparent red curved
CNMB/4/HPRC	Hinged transparent red curved
CNMB/5/HPRC	Hinged transparent red curved
CNMB/9/HPRC	Hinged transparent red curved
CNMB/2/HPGC	Hinged grey curved
CNMB/3/HPGC	Hinged grey curved
CNMB/4/HPGC	Hinged grey curved
CNMB/5/HPGC	Hinged grey curved
CNMB/6/HPGC	Hinged grey curved
CNMB/9/HPGC	Hinged grey curved

Kits available from our distributors
 Kits consist of base, top panel, terminal, and clips for rail or wall mounting. Each kit includes 2 perforated terminal covers enabling customisation as required. CNMB/6/kit, CNMB/9/kit & CNMB/12/kit are supplied with additional blank terminal guards.

Ansprechpartner für Deutschland:

AXXATRONIC GmbH, Alemannenstrasse 10, 71296 Heimsheim

Telefon: (0 70 33) 46 66 1 - 0, Fax: (0 70 33) 46 66 1 - 23, www.axxatronic.de, info@axxatronic.de



FM28614
 BS EN ISO
 9001:
 2000