

Data sheet | Item number: 261-423/341-000

2-conductor terminal strip; with fixing flange; for screw or similar mounting types; Fixing hole 3.2 mm Ø; with 209-123 mounting carrier for DIN 35 rail; with push-button

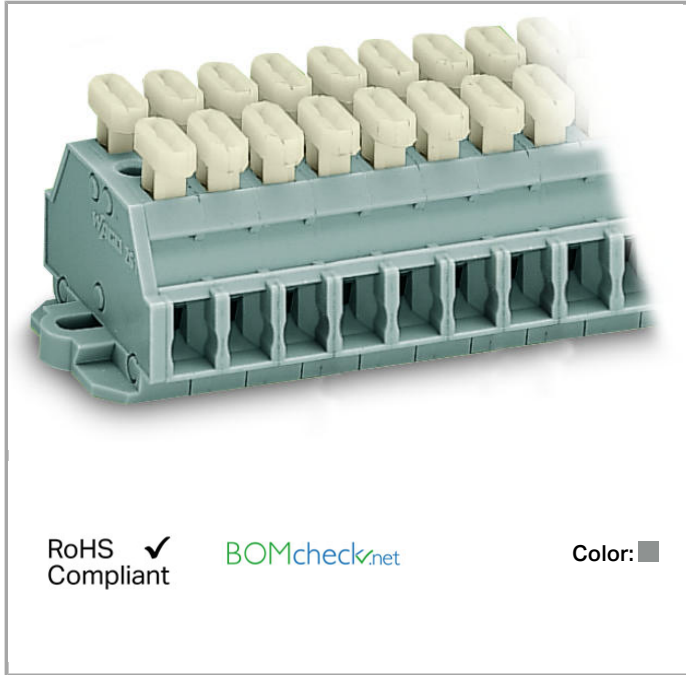

www.wago.com/261-423/341-000



RoHS
Compliant ✓

BOMcheck.net

Color: ■

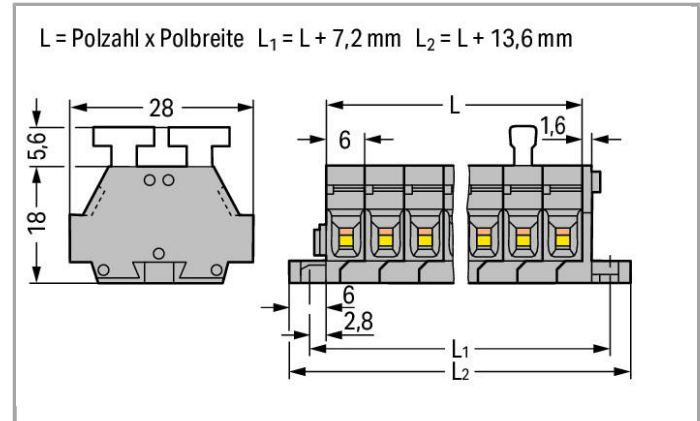

Data

Electrical data

Ratings per IEC/EN 60664-1

Rated voltage (III / 3)	500 V
Rated impulse voltage (III / 3)	6 kV
Rated current	24 A
Legend (ratings)	(III / 3) ≙ Overvoltage category III / Pollution degree 3

Connection data

Connection technology	CAGE CLAMP®
Actuation type	Operating tool Push-button
Connectable conductor materials	Copper Aluminum
Solid conductor	0.08 ... 2.5 mm ² / 28 ... 14 AWG
Fine-stranded conductor	0.08 ... 2.5 mm ² / 28 ... 14 AWG
Strip length	8 ... 9 mm / 0.31 ... 0.35 Inch
No. of poles	3
Total number of connection points	6

Total number of potentials	3
Number of levels	1
Type of wiring	Side-entry wiring

Geometrical Data

Width	31.6 mm / 1.244 inch
Height from the surface	23.2 mm / 0.913 inch
Depth	28 mm / 1.102 inch

Mechanical data

Design	horizontal
Mounting type	Mounting flange
Marking level	Side marking

Material Data





Color	gray
Fire load	0.192 MJ
Weight	9.151 g

Commercial data

Country of origin	DE
GTIN	4044918627351
Customs Tariff No.	85369010000

Compatible products

tools

	Item no.: 209-132 Operating tool; for connecting comb-style jumper bar; 2-way; of insulating material	www.wago.com/209-132
	Item no.: 210-657 Operating tool with partially insulated shaft; Blade (3.5 x 0.5) mm; short	www.wago.com/210-657
	Item no.: 210-658 Operating tool with partially insulated shaft; Blade (3.5 x 0.5) mm; short; angled	www.wago.com/210-658
	Item no.: 210-720 Operating tool with partially insulated shaft; Type 2, blade (3.5 x 0.5) mm	www.wago.com/210-720

Jumper

	Item no.: 261-402 Comb-style jumper bar; insulated; 2-way; reduces conductor size to 1.5 mm	www.wago.com/261-402
--	---	--

check



Item no.: 210-136
Test plug; 2 mm Ø; with 500 mm cable

www.wago.com/210-136

General accessories



Item no.: 209-123
Mounting foot with screw; can be screwed on terminal blocks with fixing flange; 6.4 mm wide

www.wago.com/209-123

ferrule



Item no.: 216-101
Ferrule; Sleeve for 0.5 mm² / AWG 22; uninsulated; electro-tin plated

www.wago.com/216-101



Item no.: 216-102
Ferrule; Sleeve for 0.75 mm² / AWG 20; uninsulated; electro-tin plated

www.wago.com/216-102



Item no.: 216-103
Ferrule; Sleeve for 1 mm² / AWG 18; uninsulated; electro-tin plated

www.wago.com/216-103



Item no.: 216-104
Ferrule; Sleeve for 1.5 mm² / AWG 16; uninsulated; electro-tin plated

www.wago.com/216-104



Item no.: 216-106
Ferrule; Sleeve for 2.5 mm² / AWG 14; uninsulated; electro-tin plated

www.wago.com/216-106



Item no.: 216-121
Ferrule; Sleeve for 0.5 mm² / AWG 22; uninsulated; electro-tin plated

www.wago.com/216-121



Item no.: 216-122
Ferrule; Sleeve for 0.75 mm² / AWG 20; uninsulated; electro-tin plated

www.wago.com/216-122



Item no.: 216-123
Ferrule; Sleeve for 1 mm² / AWG 18; uninsulated; electro-tin plated

www.wago.com/216-123



Item no.: 216-124
Ferrule; Sleeve for 1.5 mm² / AWG 16; uninsulated; electro-tin plated

www.wago.com/216-124



Item no.: 216-131
Ferrule; Sleeve for 0.25 mm² / AWG 24; uninsulated; electro-tin plated

www.wago.com/216-131



Item no.: 216-132
Ferrule; Sleeve for 0.34 mm² / AWG 24; uninsulated; electro-tin plated

www.wago.com/216-132



Item no.: 216-151
Ferrule; Sleeve for 0.25 mm² / AWG 24; uninsulated; electro-tin plated

www.wago.com/216-151



Item no.: 216-152
Ferrule; Sleeve for 0.34 mm² / AWG 24; uninsulated; electro-tin plated

www.wago.com/216-152



Item no.: 216-201
Ferrule; Sleeve for 0.5 mm² / AWG 22; insulated; electro-tin plated

www.wago.com/216-201



Item no.: 216-202
Ferrule; Sleeve for 0.75 mm² / AWG 20; insulated; electro-tin plated











www.wago.com/216-202



Item no.: 216-203
Ferrule; Sleeve for 1 mm² / AWG 18; insulated; electro-tin plated

www.wago.com/216-203





Item no.: 216-204













	Ferrule; Sleeve for 1.5 mm ² / AWG 16; insulated; electro-tin plated	www.wago.com/216-204
	Item no.: 216-205 Ferrule; Sleeve for 2.08 mm ² / AWG 14; insulated; electro-tin plated	www.wago.com/216-205
	Item no.: 216-206 Ferrule; Sleeve for 2.5 mm ² / AWG 14; insulated; electro-tin plated	www.wago.com/216-206
	Item no.: 216-221 Ferrule; Sleeve for 0.5 mm ² / AWG 22; insulated; electro-tin plated	www.wago.com/216-221
	Item no.: 216-222 Ferrule; Sleeve for 0.75 mm ² / AWG 20; insulated; electro-tin plated	www.wago.com/216-222
	Item no.: 216-223 Ferrule; Sleeve for 1 mm ² / AWG 18; insulated; electro-tin plated	www.wago.com/216-223
	Item no.: 216-224 Ferrule; Sleeve for 1.5 mm ² / AWG 16; insulated; electro-tin plated	www.wago.com/216-224
	Item no.: 216-301 Ferrule; Sleeve for 0.25 mm ² / AWG 24; insulated; electro-tin plated	www.wago.com/216-301
	Item no.: 216-302 Ferrule; Sleeve for 0.34 mm ² / AWG 24; insulated; electro-tin plated	www.wago.com/216-302
	Item no.: 216-321 Ferrule; Sleeve for 0.25 mm ² / AWG 24; insulated; electro-tin plated	www.wago.com/216-321
	Item no.: 216-322 Ferrule; Sleeve for 0.34 mm ² / AWG 24; insulated; electro-tin plated	www.wago.com/216-322

assembling

	Item no.: 209-137 Mounting adapter; can be used as end plate; 6.5 mm wide	www.wago.com/209-137
--	---	--

Marking accessories

	Item no.: 209-145 Mini-WSB Inline; for smartPRINTER; on reel; stretchable 5 - 5.2 mm; plain; snap-on type	www.wago.com/209-145
	Item no.: 209-145/000-002 Mini-WSB Inline; for smartPRINTER; on reel; stretchable 5 - 5.2 mm; plain; snap-on type	www.wago.com/209-145/000-002
	Item no.: 209-145/000-005 Mini-WSB Inline; for smartPRINTER; on reel; stretchable 5 - 5.2 mm; plain; snap-on type	www.wago.com/209-145/000-005
	Item no.: 209-145/000-006 Mini-WSB Inline; for smartPRINTER; on reel; stretchable 5 - 5.2 mm; plain; snap-on type	www.wago.com/209-145/000-006
	Item no.: 209-145/000-007 Mini-WSB Inline; for smartPRINTER; on reel; stretchable 5 - 5.2 mm; plain; snap-on type	www.wago.com/209-145/000-007

	<p>Item no.: 2009-145/000-012 Mini-WSB Inline; for smartPRINTER; on reel; stretchable 5 - 5.2 mm; plain; snap-on type</p>	www.wago.com/2009-145/000-012
	<p>Item no.: 2009-145/000-023 Mini-WSB Inline; for smartPRINTER; on reel; stretchable 5 - 5.2 mm; plain; snap-on type</p>	www.wago.com/2009-145/000-023
	<p>Item no.: 2009-145/000-024 Mini-WSB Inline; on reel; stretchable 5 - 5.2 mm; plain; snap-on type</p>	www.wago.com/2009-145/000-024
	<p>Item no.: 248-501 Miniature WSB Quick marking system; plain; Marker width 5 mm; 10 strips with 10 markers per card</p>	www.wago.com/248-501
	<p>Item no.: 248-501/000-002 Mini-WSB marking card; as card; not stretchable; plain; snap-on type</p>	www.wago.com/248-501/000-002
	<p>Item no.: 248-501/000-005 Mini-WSB marking card; as card; plain; snap-on type</p>	www.wago.com/248-501/000-005
	<p>Item no.: 248-501/000-006 Mini-WSB marking card; as card; not stretchable; plain; snap-on type</p>	www.wago.com/248-501/000-006
	<p>Item no.: 248-501/000-007 Mini-WSB marking card; as card; not stretchable; plain; snap-on type</p>	www.wago.com/248-501/000-007
	<p>Item no.: 248-501/000-012 Mini-WSB marking card; as card; not stretchable; plain; snap-on type</p>	www.wago.com/248-501/000-012
	<p>Item no.: 248-501/000-017 Mini-WSB marking card; as card; not stretchable; plain; snap-on type</p>	www.wago.com/248-501/000-017
	<p>Item no.: 248-501/000-023 Mini-WSB marking card; as card; not stretchable; plain; snap-on type</p>	www.wago.com/248-501/000-023
	<p>Item no.: 248-501/000-024 Mini-WSB marking card; as card; not stretchable; plain; snap-on type</p>	www.wago.com/248-501/000-024

Downloads

Documentation

Bid Text

261-423/341-000	Oct 11, 2017	DOC 25.1 kB	Download
-----------------	--------------	----------------	----------



smartDATA

CAD data

3D Download 261-423/341-000

URL

Download

Subject to changes.

WAGO Kontakttechnik GmbH & Co. KG

Hansastr. 27

32423 Minden

Phone: +49571 887-0 | Fax: +49571 887-169

Email: info.de@wago.com | Web: www.wago.com

Do you have any questions about our products?

We are always happy to take your call at +49 (571) 887-44222.