

Data sheet | Item number: 261-427

2-conductor terminal strip; with fixing flange; for screw or similar mounting types; Fixing hole 3.2 mm Ø; with 209-123 mounting carrier for DIN 35 rail; without push-button

www.wago.com/261-427

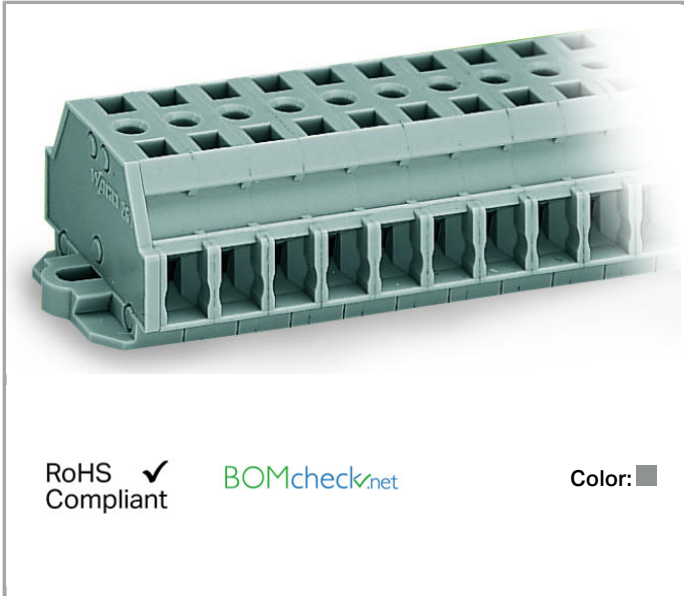

RoHS Compliant

BOMcheck.net

Color: ■

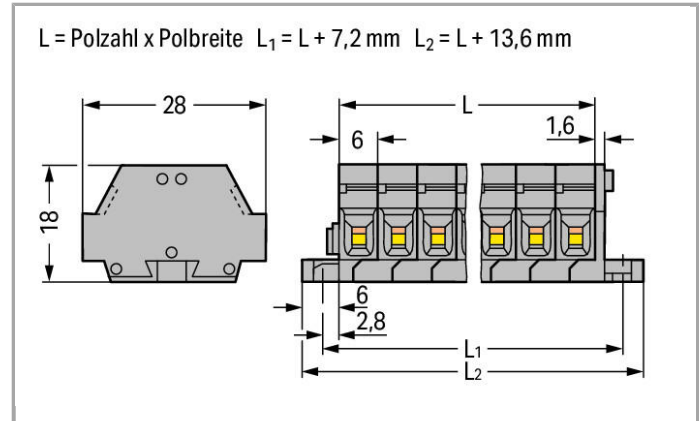

Data

Electrical data

Ratings per IEC/EN 60664-1

| | |
|---------------------------------|---|
| Rated voltage (III / 3) | 500 V |
| Rated impulse voltage (III / 3) | 6 kV |
| Rated current | 24 A |
| Legend (ratings) | (III / 3) ≙ Overvoltage category III / Pollution degree 3 |

Connection data

| | |
|-----------------------------------|--|
| Connection technology | CAGE CLAMP® |
| Actuation type | Operating tool |
| Connectable conductor materials | Copper Aluminum |
| Solid conductor | 0.08 ... 2.5 mm ² / 28 ... 14 AWG |
| Fine-stranded conductor | 0.08 ... 2.5 mm ² / 28 ... 14 AWG |
| Strip length | 8 ... 9 mm / 0.31 ... 0.35 Inch |
| No. of poles | 7 |
| Total number of connection points | 14 |
| Total number of potentials | 7 |
| Number of levels | 1 |

Type of wiring

Side-entry wiring

Geometrical Data

| | |
|-------------------------|----------------------|
| Width | 55.6 mm / 2.189 inch |
| Height from the surface | 18 mm / 0.709 inch |
| Depth | 28 mm / 1.102 inch |

Mechanical data

| | |
|---------------|-----------------|
| Design | horizontal |
| Mounting type | Mounting flange |
| Marking level | Side marking |

Material Data

| | |
|-----------|----------|
| Color | gray |
| Fire load | 0.338 MJ |
| Weight | 18.491 g |

Commercial data

| | |
|--------------------|---------------|
| Country of origin | DE |
| GTIN | 4044918627689 |
| Customs Tariff No. | 85369010000 |

Compatible products

Jumper



Item no.: 261-402

Comb-style jumper bar; insulated; 2-way; reduces conductor size to 1.5 mm

www.wago.com/261-402

check



Item no.: 210-136

Test plug; 2 mm Ø; with 500 mm cable

www.wago.com/210-136

Marking accessories



Item no.: 2009-145

Mini-WSB Inline; for smartPRINTER; on reel; stretchable 5 - 5.2 mm; plain; snap-on type

www.wago.com/2009-145

Item no.: 2009-145/000-002















Mini-WSB Inline; for smartPRINTER; on reel; stretchable 5 - 5.2 mm; plain; snap-on type





















www.wago.com/2009-145/000-002







Item no.: 2009-145/000-005

Mini-WSB Inline; for smartPRINTER; on reel; stretchable 5 - 5.2 mm; plain; snap-on type

www.wago.com/2009-145/000-005

| | | |
|--|--|--|
|  | Item no.: 2009-145/000-006 Mini-WSB Inline; for smartPRINTER; on reel; stretchable 5 - 5.2 mm; plain; snap-on type | www.wago.com/2009-145/000-006 |
|  | Item no.: 2009-145/000-007 Mini-WSB Inline; for smartPRINTER; on reel; stretchable 5 - 5.2 mm; plain; snap-on type | www.wago.com/2009-145/000-007 |
|  | Item no.: 2009-145/000-012 Mini-WSB Inline; for smartPRINTER; on reel; stretchable 5 - 5.2 mm; plain; snap-on type | www.wago.com/2009-145/000-012 |
|  | Item no.: 2009-145/000-023 Mini-WSB Inline; for smartPRINTER; on reel; stretchable 5 - 5.2 mm; plain; snap-on type | www.wago.com/2009-145/000-023 |
|  | Item no.: 2009-145/000-024 Mini-WSB Inline; on reel; stretchable 5 - 5.2 mm; plain; snap-on type | www.wago.com/2009-145/000-024 |
|  | Item no.: 248-501 Miniature WSB Quick marking system; plain; Marker width 5 mm; 10 strips with 10 markers per card | www.wago.com/248-501 |
|  | Item no.: 248-501/000-002 Mini-WSB marking card; as card; not stretchable; plain; snap-on type | www.wago.com/248-501/000-002 |
|  | Item no.: 248-501/000-005 Mini-WSB marking card; as card; plain; snap-on type | www.wago.com/248-501/000-005 |
|  | Item no.: 248-501/000-006 Mini-WSB marking card; as card; not stretchable; plain; snap-on type | www.wago.com/248-501/000-006 |
|  | Item no.: 248-501/000-007 Mini-WSB marking card; as card; not stretchable; plain; snap-on type | www.wago.com/248-501/000-007 |
|  | Item no.: 248-501/000-012 Mini-WSB marking card; as card; not stretchable; plain; snap-on type | www.wago.com/248-501/000-012 |
|  | Item no.: 248-501/000-017 Mini-WSB marking card; as card; not stretchable; plain; snap-on type | www.wago.com/248-501/000-017 |
|  | Item no.: 248-501/000-023 Mini-WSB marking card; as card; not stretchable; plain; snap-on type | www.wago.com/248-501/000-023 |
|  | Item no.: 248-501/000-024 Mini-WSB marking card; as card; not stretchable; plain; snap-on type | www.wago.com/248-501/000-024 |
| ferrule | | |
|  | Item no.: 216-101 Ferrule; Sleeve for 0.5 mm ² / AWG 22; uninsulated; electro-tin plated | www.wago.com/216-101 |

| | | |
|--|--|--|
|  | Item no.: 216-102 Ferrule; Sleeve for 0.75 mm ² / AWG 20; uninsulated; electro-tin plated | www.wago.com/216-102 |
|  | Item no.: 216-103 Ferrule; Sleeve for 1 mm ² / AWG 18; uninsulated; electro-tin plated | www.wago.com/216-103 |
|  | Item no.: 216-104 Ferrule; Sleeve for 1.5 mm ² / AWG 16; uninsulated; electro-tin plated | www.wago.com/216-104 |
|  | Item no.: 216-106 Ferrule; Sleeve for 2.5 mm ² / AWG 14; uninsulated; electro-tin plated | www.wago.com/216-106 |
|  | Item no.: 216-121 Ferrule; Sleeve for 0.5 mm ² / AWG 22; uninsulated; electro-tin plated | www.wago.com/216-121 |
|  | Item no.: 216-122 Ferrule; Sleeve for 0.75 mm ² / AWG 20; uninsulated; electro-tin plated | www.wago.com/216-122 |
|  | Item no.: 216-123 Ferrule; Sleeve for 1 mm ² / AWG 18; uninsulated; electro-tin plated | www.wago.com/216-123 |
|  | Item no.: 216-124 Ferrule; Sleeve for 1.5 mm ² / AWG 16; uninsulated; electro-tin plated | www.wago.com/216-124 |
|  | Item no.: 216-131 Ferrule; Sleeve for 0.25 mm ² / AWG 24; uninsulated; electro-tin plated | www.wago.com/216-131 |
|  | Item no.: 216-132 Ferrule; Sleeve for 0.34 mm ² / AWG 24; uninsulated; electro-tin plated | www.wago.com/216-132 |
|  | Item no.: 216-151 Ferrule; Sleeve for 0.25 mm ² / AWG 24; uninsulated; electro-tin plated | www.wago.com/216-151 |
|  | Item no.: 216-152 Ferrule; Sleeve for 0.34 mm ² / AWG 24; uninsulated; electro-tin plated | www.wago.com/216-152 |
|  | Item no.: 216-201 Ferrule; Sleeve for 0.5 mm ² / AWG 22; insulated; electro-tin plated | www.wago.com/216-201 |
|  | Item no.: 216-202 Ferrule; Sleeve for 0.75 mm ² / AWG 20; insulated; electro-tin plated | www.wago.com/216-202 |
|  | Item no.: 216-203 Ferrule; Sleeve for 1 mm ² / AWG 18; insulated; electro-tin plated | www.wago.com/216-203 |
|  | Item no.: 216-204 Ferrule; Sleeve for 1.5 mm ² / AWG 16; insulated; electro-tin plated | www.wago.com/216-204 |
|  | Item no.: 216-205 Ferrule; Sleeve for 2.08 mm ² / AWG 14; insulated; electro-tin plated | www.wago.com/216-205 |
|  | Item no.: 216-206 Ferrule; Sleeve for 2.5 mm ² / AWG 14; insulated; electro-tin plated | www.wago.com/216-206 |
|  | Item no.: 216-221 Ferrule; Sleeve for 0.5 mm ² / AWG 22; insulated; electro-tin plated | www.wago.com/216-221 |
|  | Item no.: 216-222 Ferrule; Sleeve for 0.75 mm ² / AWG 20; insulated; electro-tin plated | www.wago.com/216-222 |

| | | |
|---|--|--|
|  | Item no.: 216-223 Ferrule; Sleeve for 1 mm ² / AWG 18; insulated; electro-tin plated | www.wago.com/216-223 |
|  | Item no.: 216-224 Ferrule; Sleeve for 1.5 mm ² / AWG 16; insulated; electro-tin plated | www.wago.com/216-224 |
|  | Item no.: 216-301 Ferrule; Sleeve for 0.25 mm ² / AWG 24; insulated; electro-tin plated | www.wago.com/216-301 |
|  | Item no.: 216-302 Ferrule; Sleeve for 0.34 mm ² / AWG 24; insulated; electro-tin plated | www.wago.com/216-302 |
|  | Item no.: 216-321 Ferrule; Sleeve for 0.25 mm ² / AWG 24; insulated; electro-tin plated | www.wago.com/216-321 |
|  | Item no.: 216-322 Ferrule; Sleeve for 0.34 mm ² / AWG 24; insulated; electro-tin plated | www.wago.com/216-322 |





assembling

| | | |
|--|---|--|
|  | Item no.: 209-137 Mounting adapter; can be used as end plate; 6.5 mm wide | www.wago.com/209-137 |
|--|---|--|

General accessories

| | | |
|---|---|--|
|  | Item no.: 209-123 Mounting foot with screw; can be screwed on terminal blocks with fixing flange; 6.4 mm wide | www.wago.com/209-123 |
|---|---|--|

tools

| | | |
|--|---|--|
|  | Item no.: 209-132 Operating tool; for connecting comb-style jumper bar; 2-way; of insulating material | www.wago.com/209-132 |
|  | Item no.: 210-657 Operating tool with partially insulated shaft; Blade (3.5 x 0.5) mm; short | www.wago.com/210-657 |
|  | Item no.: 210-658 Operating tool with partially insulated shaft; Blade (3.5 x 0.5) mm; short; angled | www.wago.com/210-658 |
|  | Item no.: 210-720 Operating tool with partially insulated shaft; Type 2, blade (3.5 x 0.5) mm | www.wago.com/210-720 |

Downloads

Documentation

Bid Text

| | | | |
|---------|--------------|----------------|----------|
| 261-427 | Oct 11, 2017 | DOC 25.1 kB | Download |
|---------|--------------|----------------|----------|

smartDATA

CAD data



3D Download 261-427

URL

Download

Subject to changes.

WAGO Kontakttechnik GmbH & Co. KG
Hansastr. 27
32423 Minden
Phone: +49571 887-0 | Fax: +49571 887-169
Email: info.de@wago.com | Web: www.wago.com

Do you have any questions about our products?
We are always happy to take your call at +49 (571) 887-44222.