

1591SFL Enclosure

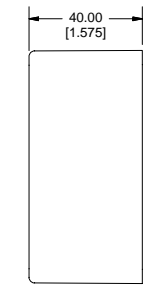

SIDE VIEW OF BOX

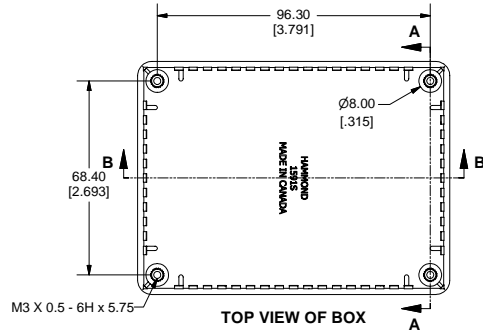

TOP VIEW OF BOX

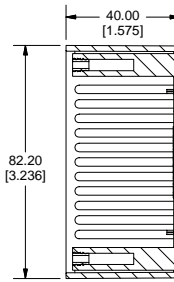

SECTION A-A

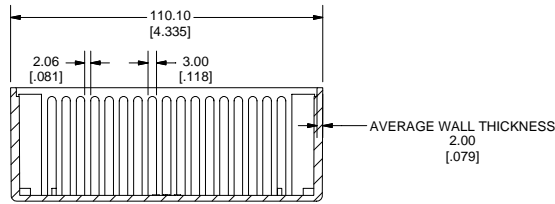

SECTION B-B

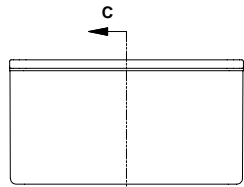

END VIEW OF BOX

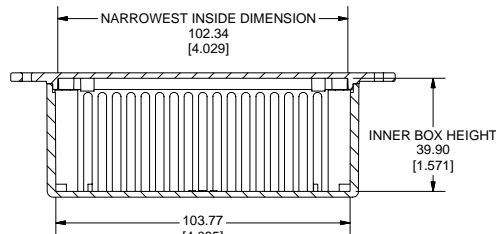

SECTION C-C

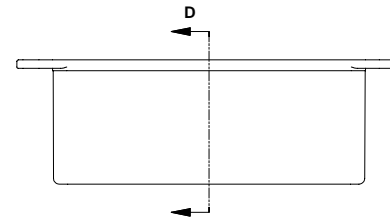

SIDE VIEW OF ENCLOSURE

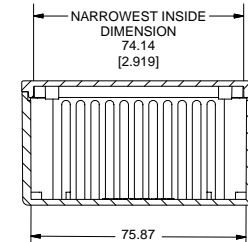

SECTION D-D

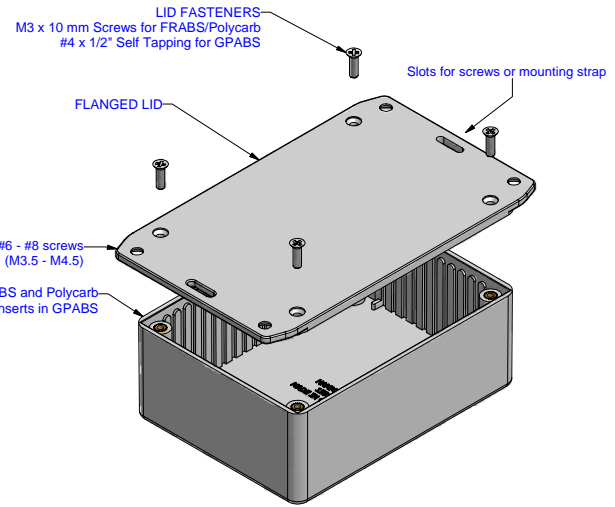

EXPLODED VIEW OF ASSEMBLY

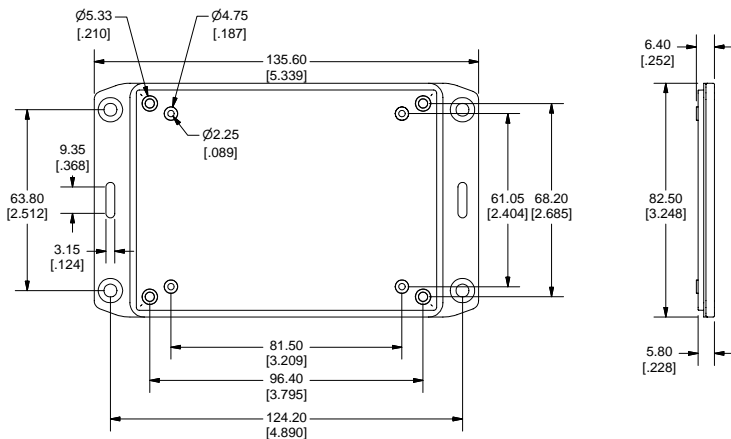

Note:

Enclosures can be Factory Modified (Milling, Drilling, Printing etc.)
 Solid models of this enclosure available in STEP or IGES Format.
 Contact Factory mjm@hammondmfg.com

PART NUMBERS		
1591S Flanged Lid Enclosures		
Material	Colour	Part Number
FRABS UL94	Black	1591SFLBK
- V0	Grey	1591SFLGY
Accessories		
Description	Part Number	
Used with ABS Enclosures	PC Board Card Adapters	See Accessories Section
	Replacement Screws, Flat Head Phillips Nickel Plated Pack of 100.	1591MS100 1591MS100BK (Black)
Recommended Torque on Fasteners (no lubrication)		
	M3 - 0.5 x 10mm Screws	30-40 cN*m
	#4 x 0.5 Screws	30-40 cN*m