

Enclosures can be Factory Modified (Milling, Drilling, Printing etc.)
 Contact Factory mjm@hammondmfg.com for quotes
 Solid models of this enclosure available in STEP or IGES.

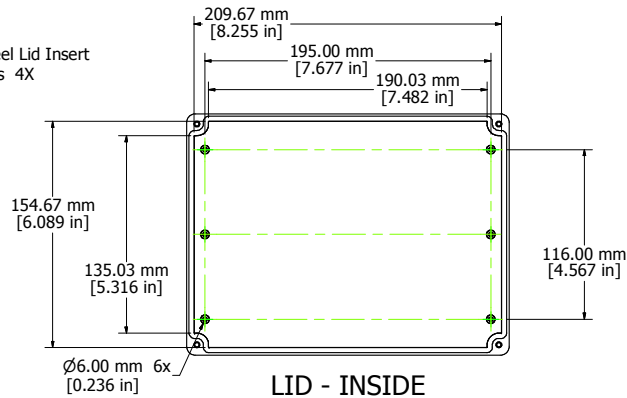

RP1455
Material: ABS (UL94-HB), Light Gray Color
Lid Screws: M3.5 x 10, 304 Stainless
Gasket: EDPM Cord.
Circuit Board Screws, 4 Supplied (M3 self tap)
Suggested Lid Screw Torque: 30 ozf-in (21 cN-m)

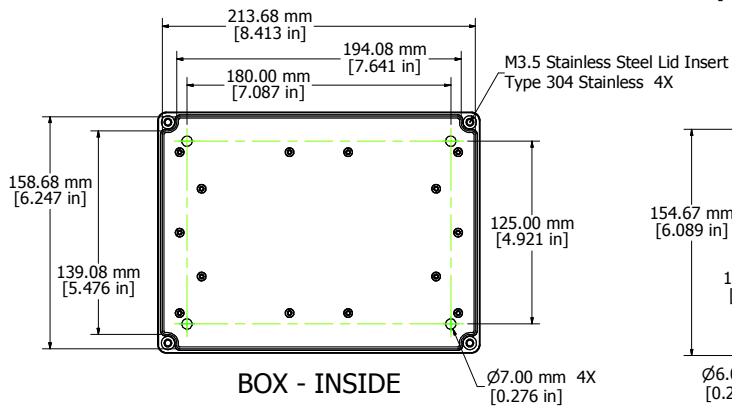

**HAMMOND
 MANUFACTURING™**

RP1455

www.hammondmfg.com