

ASSEMBLY - TOP

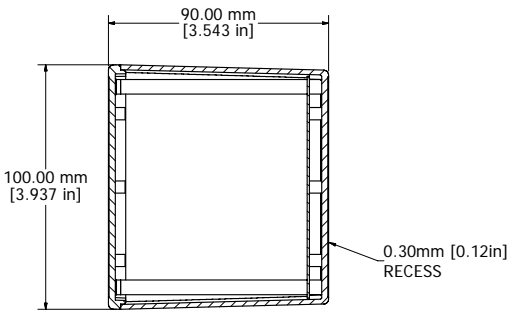

SECTION A-A

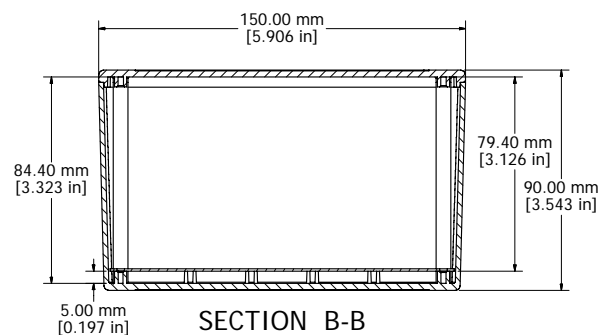
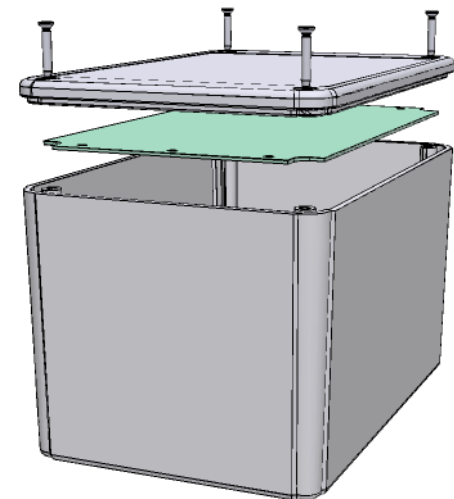

SECTION B-B

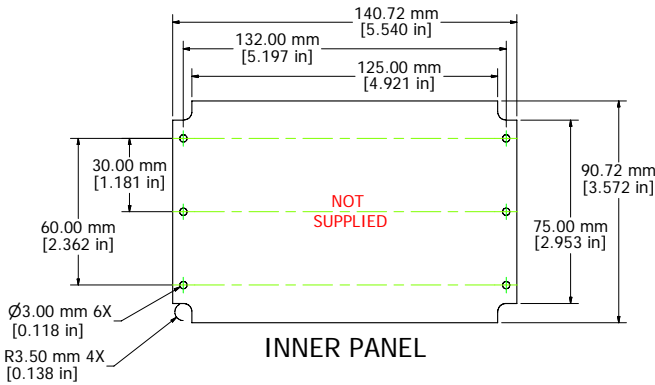

INNER PANEL

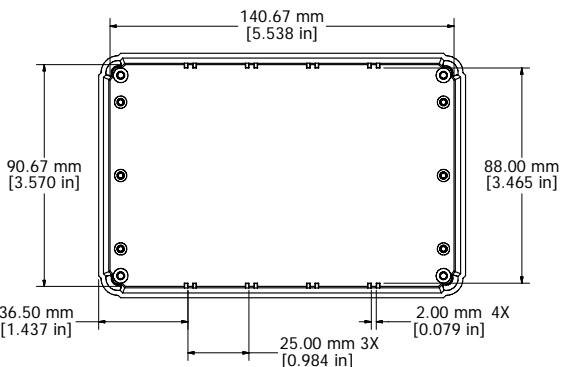

BOX - INSIDE

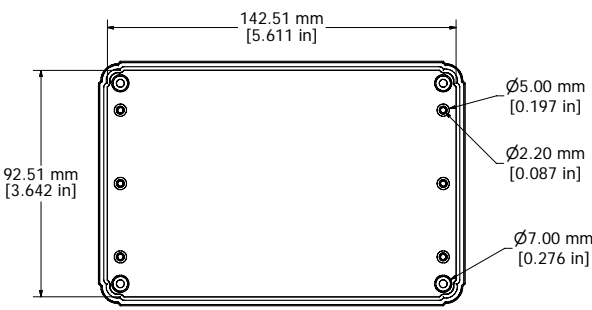

LID - INSIDE

Enclosures can be Factory Modified (Milling, Drilling, Printing etc.)
 Contact Factory mjm@hammondmfg.com for quotes
 Solid models of this enclosure available in STEP or IGES.

RL6465
Material: ABS (UL94-HB), Light Gray color
Lid Screws: M2.6 x 18
Circuit Board Screws, 4 Supplied (M2.6 self tap)
Suggested Lid Screw Torque: 30 ozf-in (21 cN-m)



**HAMMOND
 MANUFACTURING™**

RL6465

www.hammondmfg.com