

Data sheet | Item number: 262-285

4-conductor Ex e II terminal strip; with snap-in mounting feet; for plate thickness 0.6 - 1.2 mm; Fixing hole 3.5 mm Ø; also fits 210-154 aluminum rail or with 209-123 mounting carrier for DIN 35 rail; suitable for Ex e II applications; 5-pole

www.wago.com/262-285

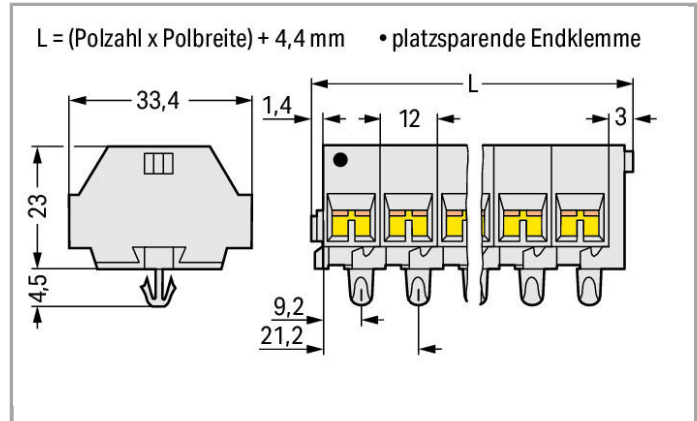

RoHS Compliant

BOMcheck.net

Color: ■

Data

Electrical data

Rated voltage EN (Ex e II) 550 V

Ratings per IEC/EN 60664-1

Rated current 30 A

Connection data

Connection technology	CAGE CLAMP®
Actuation type	Operating tool
Connectable conductor materials	Copper Aluminum
Solid conductor	0.5 ... 4 mm ² / 20 ... 12 AWG
Fine-stranded conductor	0.5 ... 4 mm ² / 20 ... 12 AWG
Strip length	9 ... 10 mm / 0.35 ... 0.39 Inch
No. of poles	5
Total number of connection points	20
Total number of potentials	5

Number of levels	1
Type of wiring	Side-entry wiring

Geometrical Data

Width	64.4 mm / 2.535 inch
Height from the surface	23 mm / 0.906 inch
Depth	33.5 mm / 1.319 inch

Mechanical data

Design	horizontal
Mounting type	Snap-in mounting foot
Marking level	Side marking

Material Data



Color	light gray
Fire load	0.607 MJ
Weight	36.7 g

Commercial data

Country of origin	DE
GTIN	4044918639194
Customs Tariff No.	85369010000

Approvals / Certificates

Ex-Approvals

Logo	Approval	Certificate name
	AEx UL International Germany GmbH c/o Physikalisch Technische Bundesanstalt	E185892 sec 6
	ATEX Physikalisch Technische Bundesanstalt (PTB)	PTB 98 ATEX 3125 U (II 2 G EEx e II)

Country specific Approvals



Logo	Approval	Certificate name
	CSA DEKRA Certification B.V.	70010891

UL-Approvals





Logo	Approval	Certificate name
	UR Underwriters Laboratories Inc.	E45172

Compatible products

assembling

	Item no.: 209-120 Mounting foot; can be snapped on terminal blocks with snap-in mounting foot; for mounting on relay-modules; 6.4 mm wide	www.wago.com/209-120
	Item no.: 209-137 Mounting adapter; can be used as end plate; 6.5 mm wide	www.wago.com/209-137

tools

	Item no.: 209-132 Operating tool; for connecting comb-style jumper bar; 2-way; of insulating material	www.wago.com/209-132
	Item no.: 210-657 Operating tool with partially insulated shaft; Blade (3.5 x 0.5) mm; short	www.wago.com/210-657
	Item no.: 210-658 Operating tool with partially insulated shaft; Blade (3.5 x 0.5) mm; short; angled	www.wago.com/210-658
	Item no.: 210-720 Operating tool with partially insulated shaft; Type 2, blade (3.5 x 0.5) mm	www.wago.com/210-720

Carrier rail

	Item no.: 210-154 Aluminum carrier rail; 1000 mm long; 18 mm wide; 7 mm high	www.wago.com/210-154
--	--	--



General accessories



















	Item no.: 209-122 Plastic end stop; for WSB markers; for 210-154 aluminum rail	www.wago.com/209-122
--	--	--













Jumper













	Item no.: 262-402 Comb-style jumper bar; insulated; 2-way; reduces conductor size to 2.5 mm	www.wago.com/262-402
--	---	--

ferrule

	Item no.: 216-101 Ferrule; Sleeve for 0.5 mm ² / AWG 22; uninsulated; electro-tin plated	www.wago.com/216-101
	Item no.: 216-102 Ferrule; Sleeve for 0.75 mm ² / AWG 20; uninsulated; electro-tin plated	www.wago.com/216-102
	Item no.: 216-103 Ferrule; Sleeve for 1 mm ² / AWG 18; uninsulated; electro-tin plated	www.wago.com/216-103

	Item no.: 216-104 Ferrule; Sleeve for 1.5 mm ² / AWG 16; uninsulated; electro-tin plated	www.wago.com/216-104
	Item no.: 216-108 Ferrule; Sleeve for 6 mm ² / AWG 10; uninsulated; electro-tin plated	www.wago.com/216-108
	Item no.: 216-109 Ferrule; Sleeve for 10 mm ² / AWG 8; uninsulated; electro-tin plated	www.wago.com/216-109
	Item no.: 216-110 Ferrule; Sleeve for 16 mm ² / AWG 6; uninsulated; electro-tin plated	www.wago.com/216-110
	Item no.: 216-121 Ferrule; Sleeve for 0.5 mm ² / AWG 22; uninsulated; electro-tin plated	www.wago.com/216-121
	Item no.: 216-122 Ferrule; Sleeve for 0.75 mm ² / AWG 20; uninsulated; electro-tin plated	www.wago.com/216-122
	Item no.: 216-123 Ferrule; Sleeve for 1 mm ² / AWG 18; uninsulated; electro-tin plated	www.wago.com/216-123
	Item no.: 216-124 Ferrule; Sleeve for 1.5 mm ² / AWG 16; uninsulated; electro-tin plated	www.wago.com/216-124
	Item no.: 216-131 Ferrule; Sleeve for 0.25 mm ² / AWG 24; uninsulated; electro-tin plated	www.wago.com/216-131
	Item no.: 216-132 Ferrule; Sleeve for 0.34 mm ² / AWG 24; uninsulated; electro-tin plated	www.wago.com/216-132
	Item no.: 216-141 Ferrule; Sleeve for 0.5 mm ² / AWG 22; uninsulated; electro-tin plated; electrolytic copper; gastight crimped; acc. to DIN 46228, Part 1/08.92	www.wago.com/216-141
	Item no.: 216-142 Ferrule; Sleeve for 0.75 mm ² / AWG 20; uninsulated; electro-tin plated; electrolytic copper; gastight crimped; acc. to DIN 46228, Part 1/08.92	www.wago.com/216-142
	Item no.: 216-143 Ferrule; Sleeve for 1 mm ² / AWG 18; uninsulated; electro-tin plated; electrolytic copper; gastight crimped; acc. to DIN 46228, Part 1/08.92	www.wago.com/216-143
	Item no.: 216-144 Ferrule; Sleeve for 1.5 mm ² / AWG 16; uninsulated; electro-tin plated; electrolytic copper; gastight crimped; acc. to DIN 46228, Part 1/08.92	www.wago.com/216-144
	Item no.: 216-151 Ferrule; Sleeve for 0.25 mm ² / AWG 24; uninsulated; electro-tin plated	www.wago.com/216-151
	Item no.: 216-152 Ferrule; Sleeve for 0.34 mm ² / AWG 24; uninsulated; electro-tin plated	www.wago.com/216-152
	Item no.: 216-201 Ferrule; Sleeve for 0.5 mm ² / AWG 22; insulated; electro-tin plated	www.wago.com/216-201
	Item no.: 216-202 Ferrule; Sleeve for 0.75 mm ² / AWG 20; insulated; electro-tin plated	www.wago.com/216-202
	Item no.: 216-203 Ferrule; Sleeve for 1 mm ² / AWG 18; insulated; electro-tin plated	www.wago.com/216-203

	Item no.: 216-204 Ferrule; Sleeve for 1.5 mm ² / AWG 16; insulated; electro-tin plated	www.wago.com/216-204
	Item no.: 216-205 Ferrule; Sleeve for 2.08 mm ² / AWG 14; insulated; electro-tin plated	www.wago.com/216-205
	Item no.: 216-206 Ferrule; Sleeve for 2.5 mm ² / AWG 14; insulated; electro-tin plated	www.wago.com/216-206
	Item no.: 216-208 Ferrule; Sleeve for 6 mm ² / AWG 10; insulated; electro-tin plated; electrolytic copper; gastight crimped; acc. to DIN 46228, Part 4/09.90	www.wago.com/216-208
	Item no.: 216-209 Ferrule; Sleeve for 10 mm ² / AWG 8; insulated; electro-tin plated	www.wago.com/216-209
	Item no.: 216-210 Ferrule; Sleeve for 16 mm ² / AWG 6; insulated; electro-tin plated; electrolytic copper; gastight crimped; acc. to DIN 46228, Part 4/09.90	www.wago.com/216-210
	Item no.: 216-221 Ferrule; Sleeve for 0.5 mm ² / AWG 22; insulated; electro-tin plated	www.wago.com/216-221
	Item no.: 216-222 Ferrule; Sleeve for 0.75 mm ² / AWG 20; insulated; electro-tin plated	www.wago.com/216-222
	Item no.: 216-223 Ferrule; Sleeve for 1 mm ² / AWG 18; insulated; electro-tin plated	www.wago.com/216-223
	Item no.: 216-224 Ferrule; Sleeve for 1.5 mm ² / AWG 16; insulated; electro-tin plated	www.wago.com/216-224
	Item no.: 216-241 Ferrule; Sleeve for 0.5 mm ² / AWG 22; insulated; electro-tin plated; electrolytic copper; gastight crimped; acc. to DIN 46228, Part 4/09.90	www.wago.com/216-241
	Item no.: 216-242 Ferrule; Sleeve for 0.75 mm ² / AWG 20; insulated; electro-tin plated; electrolytic copper; gastight crimped; acc. to DIN 46228, Part 4/09.90	www.wago.com/216-242
	Item no.: 216-243 Ferrule; Sleeve for 1 mm ² / AWG 18; insulated; electro-tin plated; electrolytic copper; gastight crimped; acc. to DIN 46228, Part 4/09.90	www.wago.com/216-243
	Item no.: 216-244 Ferrule; Sleeve for 1.5 mm ² / AWG 16; insulated; electro-tin plated; electrolytic copper; gastight crimped; acc. to DIN 46228, Part 4/09.90	www.wago.com/216-244
	Item no.: 216-246 Ferrule; Sleeve for 2.5 mm ² / AWG 14; insulated; electro-tin plated; electrolytic copper; gastight crimped; acc. to DIN 46228, Part 4/09.90	www.wago.com/216-246
	Item no.: 216-262 Ferrule; Sleeve for 0.75 mm ² / AWG 20; insulated; electro-tin plated; electrolytic copper; gastight crimped; acc. to DIN 46228, Part 4/09.90	www.wago.com/216-262
	Item no.: 216-263 Ferrule; Sleeve for 1 mm ² / AWG 18; insulated; electro-tin plated; electrolytic copper; gastight crimped; acc. to DIN 46228, Part 4/09.90	www.wago.com/216-263
	Item no.: 216-264 Ferrule; Sleeve for 1.5 mm ² / AWG 16; insulated; electro-tin plated; electrolytic copper; gastight crimped; acc. to DIN 46228, Part 4/09.90	www.wago.com/216-264
	Item no.: 216-266	

	Ferrule; Sleeve for 2.5 mm ² / AWG 14; insulated; electro-tin plated; electrolytic copper; gastight crimped; acc. to DIN 46228, Part 4/09.90	www.wago.com/216-266
	Item no.: 216-267 Ferrule; Sleeve for 4 mm ² / AWG 12; insulated; electro-tin plated; electrolytic copper; gastight crimped; acc. to DIN 46228, Part 4/09.90	www.wago.com/216-267
	Item no.: 216-284 Ferrule; Sleeve for 1.5 mm ² / AWG 16; insulated; electro-tin plated; electrolytic copper; gastight crimped; acc. to DIN 46228, Part 4/09.90	www.wago.com/216-284
	Item no.: 216-286 Ferrule; Sleeve for 2.5 mm ² / AWG 14; insulated; electro-tin plated; electrolytic copper; gastight crimped; acc. to DIN 46228, Part 4/09.90	www.wago.com/216-286
	Item no.: 216-287 Ferrule; Sleeve for 4 mm ² / AWG 12; insulated; electro-tin plated; electrolytic copper; gastight crimped; acc. to DIN 46228, Part 4/09.90	www.wago.com/216-287
	Item no.: 216-288 Ferrule; Sleeve for 6 mm ² / AWG 10; insulated; electro-tin plated; electrolytic copper; gastight crimped; acc. to DIN 46228, Part 4/09.90	www.wago.com/216-288
	Item no.: 216-289 Ferrule; Sleeve for 10 mm ² / AWG 8; insulated; electro-tin plated; electrolytic copper; gastight crimped; acc. to DIN 46228, Part 4/09.90	www.wago.com/216-289
	Item no.: 216-301 Ferrule; Sleeve for 0.25 mm ² / AWG 24; insulated; electro-tin plated	www.wago.com/216-301
	Item no.: 216-302 Ferrule; Sleeve for 0.34 mm ² / AWG 24; insulated; electro-tin plated	www.wago.com/216-302
	Item no.: 216-321 Ferrule; Sleeve for 0.25 mm ² / AWG 24; insulated; electro-tin plated	www.wago.com/216-321
	Item no.: 216-322 Ferrule; Sleeve for 0.34 mm ² / AWG 24; insulated; electro-tin plated	www.wago.com/216-322
End plate		
	Item no.: 262-363 End plate; with fixing flange	www.wago.com/262-363
	Item no.: 262-373 End plate; with snap-in mounting foot	www.wago.com/262-373

Downloads

Documentation

Bid Text

262-285	Oct 11, 2017	DOC 25.1 kB	Download
---------	--------------	----------------	----------



Subject to changes.

WAGO Kontakttechnik GmbH & Co. KG
Hansastr. 27
32423 Minden
Phone: +49571 887-0 | Fax: +49571 887-169
Email: info.de@wago.com | Web: www.wago.com

Do you have any questions about our products?
We are always happy to take your call at +49 (571) 887-44222.