

## Data sheet | Item number: 262-292

4-conductor Ex e II terminal strip; with snap-in mounting feet; for plate thickness 0.6 - 1.2 mm; Fixing hole 3.5 mm Ø; also fits 210-154 aluminum rail or with 209-123 mounting carrier for DIN 35 rail; suitable for Ex e II applications; 12-pole

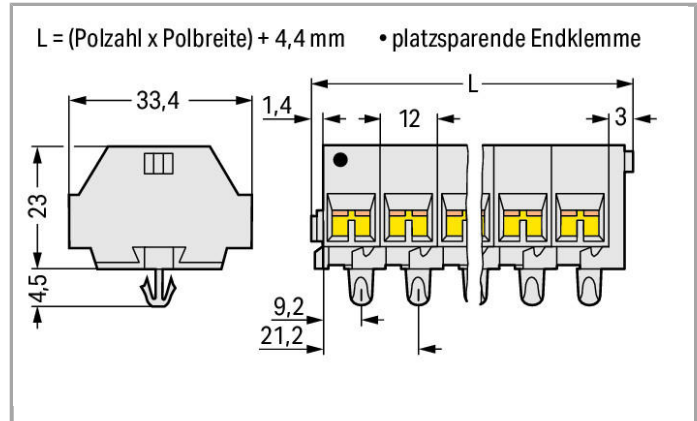

[www.wago.com/262-292](http://www.wago.com/262-292)



RoHS  Compliant

BOMcheck.net

Color: ■

### Data

#### Electrical data

Rated voltage EN (Ex e II) 550 V

#### Ratings per IEC/EN 60664-1

Rated current 30 A

#### Connection data

Connection technology	CAGE CLAMP®
Actuation type	Operating tool
Connectable conductor materials	Copper Aluminum
Solid conductor	0.5 ... 4 mm <sup>2</sup> / 20 ... 12 AWG
Fine-stranded conductor	0.5 ... 4 mm <sup>2</sup> / 20 ... 12 AWG
Strip length	9 ... 10 mm / 0.35 ... 0.39 Inch
No. of poles	12
Total number of connection points	48
Total number of potentials	12

Number of levels	1
Type of wiring	Side-entry wiring

### Geometrical Data

Width	148.4 mm / 5.843 inch
Height from the surface	23 mm / 0.906 inch
Depth	33.5 mm / 1.319 inch

### Mechanical data

Design	horizontal
Mounting type	Snap-in mounting foot
Marking level	Side marking

### Material Data



Color	light gray
Fire load	1.391 MJ
Weight	86.834 g

### Commercial data

Country of origin	DE
GTIN	4044918639262
Customs Tariff No.	85369010000

### Approvals / Certificates

#### Ex-Approvals

Logo	Approval	Certificate name
	AEx UL International Germany GmbH c/o Physikalisch Technische Bundesanstalt	E185892 sec 6
	ATEX Physikalisch Technische Bundesanstalt (PTB)	PTB 98 ATEX 3125 U (II 2 G EEx e II)

#### Country specific Approvals





Logo	Approval	Certificate name
	CSA DEKRA Certification B.V.	70010891

#### UL-Approvals

Logo	Approval	Certificate name
	<b>UR</b> Underwriters Laboratories Inc.	E45172

## Compatible products

### tools

	<b>Item no.: 209-132</b> Operating tool; for connecting comb-style jumper bar; 2-way; of insulating material	<a href="http://www.wago.com/209-132">www.wago.com/209-132</a>
	<b>Item no.: 210-657</b> Operating tool with partially insulated shaft; Blade (3.5 x 0.5) mm; short	<a href="http://www.wago.com/210-657">www.wago.com/210-657</a>
	<b>Item no.: 210-658</b> Operating tool with partially insulated shaft; Blade (3.5 x 0.5) mm; short; angled	<a href="http://www.wago.com/210-658">www.wago.com/210-658</a>
	<b>Item no.: 210-720</b> Operating tool with partially insulated shaft; Type 2, blade (3.5 x 0.5) mm	<a href="http://www.wago.com/210-720">www.wago.com/210-720</a>



### General accessories

	<b>Item no.: 209-122</b> Plastic end stop; for WSB markers; for 210-154 aluminum rail	<a href="http://www.wago.com/209-122">www.wago.com/209-122</a>
-----------------------------------------------------------------------------------	------------------------------------------------------------------------------------------	----------------------------------------------------------------

### Jumper

	<b>Item no.: 262-402</b> Comb-style jumper bar; insulated; 2-way; reduces conductor size to 2.5 mm	<a href="http://www.wago.com/262-402">www.wago.com/262-402</a>
------------------------------------------------------------------------------------	-------------------------------------------------------------------------------------------------------	----------------------------------------------------------------

### assembling

	<b>Item no.: 209-120</b> Mounting foot; can be snapped on terminal blocks with snap-in mounting foot; for mounting on relay-modules; 6.4 mm wide	<a href="http://www.wago.com/209-120">www.wago.com/209-120</a>
	<b>Item no.: 209-137</b> Mounting adapter; can be used as end plate; 6.5 mm wide	<a href="http://www.wago.com/209-137">www.wago.com/209-137</a>



















### Carrier rail

















	<b>Item no.: 210-154</b> Aluminum carrier rail; 1000 mm long; 18 mm wide; 7 mm high	<a href="http://www.wago.com/210-154">www.wago.com/210-154</a>
------------------------------------------------------------------------------------	----------------------------------------------------------------------------------------	----------------------------------------------------------------













### End plate

	<b>Item no.: 262-363</b> End plate; with fixing flange	<a href="http://www.wago.com/262-363">www.wago.com/262-363</a>
	<b>Item no.: 262-373</b> End plate; with snap-in mounting foot	<a href="http://www.wago.com/262-373">www.wago.com/262-373</a>

### ferrule

	<b>Item no.: 216-101</b> Ferrule; Sleeve for 0.5 mm <sup>2</sup> / AWG 22; uninsulated; electro-tin plated	<a href="http://www.wago.com/216-101">www.wago.com/216-101</a>
	<b>Item no.: 216-102</b> Ferrule; Sleeve for 0.75 mm <sup>2</sup> / AWG 20; uninsulated; electro-tin plated	<a href="http://www.wago.com/216-102">www.wago.com/216-102</a>
	<b>Item no.: 216-103</b> Ferrule; Sleeve for 1 mm <sup>2</sup> / AWG 18; uninsulated; electro-tin plated	<a href="http://www.wago.com/216-103">www.wago.com/216-103</a>
	<b>Item no.: 216-104</b> Ferrule; Sleeve for 1.5 mm <sup>2</sup> / AWG 16; uninsulated; electro-tin plated	<a href="http://www.wago.com/216-104">www.wago.com/216-104</a>
	<b>Item no.: 216-108</b> Ferrule; Sleeve for 6 mm <sup>2</sup> / AWG 10; uninsulated; electro-tin plated	<a href="http://www.wago.com/216-108">www.wago.com/216-108</a>
	<b>Item no.: 216-109</b> Ferrule; Sleeve for 10 mm <sup>2</sup> / AWG 8; uninsulated; electro-tin plated	<a href="http://www.wago.com/216-109">www.wago.com/216-109</a>
	<b>Item no.: 216-110</b> Ferrule; Sleeve for 16 mm <sup>2</sup> / AWG 6; uninsulated; electro-tin plated	<a href="http://www.wago.com/216-110">www.wago.com/216-110</a>
	<b>Item no.: 216-121</b> Ferrule; Sleeve for 0.5 mm <sup>2</sup> / AWG 22; uninsulated; electro-tin plated	<a href="http://www.wago.com/216-121">www.wago.com/216-121</a>
	<b>Item no.: 216-122</b> Ferrule; Sleeve for 0.75 mm <sup>2</sup> / AWG 20; uninsulated; electro-tin plated	<a href="http://www.wago.com/216-122">www.wago.com/216-122</a>
	<b>Item no.: 216-123</b> Ferrule; Sleeve for 1 mm <sup>2</sup> / AWG 18; uninsulated; electro-tin plated	<a href="http://www.wago.com/216-123">www.wago.com/216-123</a>
	<b>Item no.: 216-124</b> Ferrule; Sleeve for 1.5 mm <sup>2</sup> / AWG 16; uninsulated; electro-tin plated	<a href="http://www.wago.com/216-124">www.wago.com/216-124</a>
	<b>Item no.: 216-131</b> Ferrule; Sleeve for 0.25 mm <sup>2</sup> / AWG 24; uninsulated; electro-tin plated	<a href="http://www.wago.com/216-131">www.wago.com/216-131</a>
	<b>Item no.: 216-132</b> Ferrule; Sleeve for 0.34 mm <sup>2</sup> / AWG 24; uninsulated; electro-tin plated	<a href="http://www.wago.com/216-132">www.wago.com/216-132</a>
	<b>Item no.: 216-141</b> Ferrule; Sleeve for 0.5 mm <sup>2</sup> / AWG 22; uninsulated; electro-tin plated; electrolytic copper; gastight crimped; acc. to DIN 46228, Part 1/08.92	<a href="http://www.wago.com/216-141">www.wago.com/216-141</a>
	<b>Item no.: 216-142</b> Ferrule; Sleeve for 0.75 mm <sup>2</sup> / AWG 20; uninsulated; electro-tin plated; electrolytic copper; gastight crimped; acc. to DIN 46228, Part 1/08.92	<a href="http://www.wago.com/216-142">www.wago.com/216-142</a>
	<b>Item no.: 216-143</b> Ferrule; Sleeve for 1 mm <sup>2</sup> / AWG 18; uninsulated; electro-tin plated; electrolytic copper; gastight crimped; acc. to DIN 46228, Part 1/08.92	<a href="http://www.wago.com/216-143">www.wago.com/216-143</a>
	<b>Item no.: 216-144</b> Ferrule; Sleeve for 1.5 mm <sup>2</sup> / AWG 16; uninsulated; electro-tin plated; electrolytic copper; gastight crimped; acc. to DIN 46228, Part 1/08.92	<a href="http://www.wago.com/216-144">www.wago.com/216-144</a>
	<b>Item no.: 216-151</b> Ferrule; Sleeve for 0.25 mm <sup>2</sup> / AWG 24; uninsulated; electro-tin plated	<a href="http://www.wago.com/216-151">www.wago.com/216-151</a>
	<b>Item no.: 216-152</b> Ferrule; Sleeve for 0.34 mm <sup>2</sup> / AWG 24; uninsulated; electro-tin plated	<a href="http://www.wago.com/216-152">www.wago.com/216-152</a>
	<b>Item no.: 216-201</b>	

	Ferrule; Sleeve for 0.5 mm <sup>2</sup> / AWG 22; insulated; electro-tin plated	<a href="http://www.wago.com/216-201">www.wago.com/216-201</a>
	<b>Item no.: 216-202</b> Ferrule; Sleeve for 0.75 mm <sup>2</sup> / AWG 20; insulated; electro-tin plated	<a href="http://www.wago.com/216-202">www.wago.com/216-202</a>
	<b>Item no.: 216-203</b> Ferrule; Sleeve for 1 mm <sup>2</sup> / AWG 18; insulated; electro-tin plated	<a href="http://www.wago.com/216-203">www.wago.com/216-203</a>
	<b>Item no.: 216-204</b> Ferrule; Sleeve for 1.5 mm <sup>2</sup> / AWG 16; insulated; electro-tin plated	<a href="http://www.wago.com/216-204">www.wago.com/216-204</a>
	<b>Item no.: 216-205</b> Ferrule; Sleeve for 2.08 mm <sup>2</sup> / AWG 14; insulated; electro-tin plated	<a href="http://www.wago.com/216-205">www.wago.com/216-205</a>
	<b>Item no.: 216-206</b> Ferrule; Sleeve for 2.5 mm <sup>2</sup> / AWG 14; insulated; electro-tin plated	<a href="http://www.wago.com/216-206">www.wago.com/216-206</a>
	<b>Item no.: 216-208</b> Ferrule; Sleeve for 6 mm <sup>2</sup> / AWG 10; insulated; electro-tin plated; electrolytic copper; gastight crimped; acc. to DIN 46228, Part 4/09.90	<a href="http://www.wago.com/216-208">www.wago.com/216-208</a>
	<b>Item no.: 216-209</b> Ferrule; Sleeve for 10 mm <sup>2</sup> / AWG 8; insulated; electro-tin plated	<a href="http://www.wago.com/216-209">www.wago.com/216-209</a>
	<b>Item no.: 216-210</b> Ferrule; Sleeve for 16 mm <sup>2</sup> / AWG 6; insulated; electro-tin plated; electrolytic copper; gastight crimped; acc. to DIN 46228, Part 4/09.90	<a href="http://www.wago.com/216-210">www.wago.com/216-210</a>
	<b>Item no.: 216-221</b> Ferrule; Sleeve for 0.5 mm <sup>2</sup> / AWG 22; insulated; electro-tin plated	<a href="http://www.wago.com/216-221">www.wago.com/216-221</a>
	<b>Item no.: 216-222</b> Ferrule; Sleeve for 0.75 mm <sup>2</sup> / AWG 20; insulated; electro-tin plated	<a href="http://www.wago.com/216-222">www.wago.com/216-222</a>
	<b>Item no.: 216-223</b> Ferrule; Sleeve for 1 mm <sup>2</sup> / AWG 18; insulated; electro-tin plated	<a href="http://www.wago.com/216-223">www.wago.com/216-223</a>
	<b>Item no.: 216-224</b> Ferrule; Sleeve for 1.5 mm <sup>2</sup> / AWG 16; insulated; electro-tin plated	<a href="http://www.wago.com/216-224">www.wago.com/216-224</a>
	<b>Item no.: 216-241</b> Ferrule; Sleeve for 0.5 mm <sup>2</sup> / AWG 22; insulated; electro-tin plated; electrolytic copper; gastight crimped; acc. to DIN 46228, Part 4/09.90	<a href="http://www.wago.com/216-241">www.wago.com/216-241</a>
	<b>Item no.: 216-242</b> Ferrule; Sleeve for 0.75 mm <sup>2</sup> / AWG 20; insulated; electro-tin plated; electrolytic copper; gastight crimped; acc. to DIN 46228, Part 4/09.90	<a href="http://www.wago.com/216-242">www.wago.com/216-242</a>
	<b>Item no.: 216-243</b> Ferrule; Sleeve for 1 mm <sup>2</sup> / AWG 18; insulated; electro-tin plated; electrolytic copper; gastight crimped; acc. to DIN 46228, Part 4/09.90	<a href="http://www.wago.com/216-243">www.wago.com/216-243</a>
	<b>Item no.: 216-244</b> Ferrule; Sleeve for 1.5 mm <sup>2</sup> / AWG 16; insulated; electro-tin plated; electrolytic copper; gastight crimped; acc. to DIN 46228, Part 4/09.90	<a href="http://www.wago.com/216-244">www.wago.com/216-244</a>
	<b>Item no.: 216-246</b> Ferrule; Sleeve for 2.5 mm <sup>2</sup> / AWG 14; insulated; electro-tin plated; electrolytic copper; gastight crimped; acc. to DIN 46228, Part 4/09.90	<a href="http://www.wago.com/216-246">www.wago.com/216-246</a>
	<b>Item no.: 216-262</b> Ferrule; Sleeve for 0.75 mm <sup>2</sup> / AWG 20; insulated; electro-tin plated; electrolytic copper; gastight crimped; acc. to DIN 46228, Part 4/09.90	<a href="http://www.wago.com/216-262">www.wago.com/216-262</a>

	<b>Item no.: 216-263</b> Ferrule; Sleeve for 1 mm <sup>2</sup> / AWG 18; insulated; electro-tin plated; electrolytic copper; gastight crimped; acc. to DIN 46228, Part 4/09.90	<a href="http://www.wago.com/216-263">www.wago.com/216-263</a>
	<b>Item no.: 216-264</b> Ferrule; Sleeve for 1.5 mm <sup>2</sup> / AWG 16; insulated; electro-tin plated; electrolytic copper; gastight crimped; acc. to DIN 46228, Part 4/09.90	<a href="http://www.wago.com/216-264">www.wago.com/216-264</a>
	<b>Item no.: 216-266</b> Ferrule; Sleeve for 2.5 mm <sup>2</sup> / AWG 14; insulated; electro-tin plated; electrolytic copper; gastight crimped; acc. to DIN 46228, Part 4/09.90	<a href="http://www.wago.com/216-266">www.wago.com/216-266</a>
	<b>Item no.: 216-267</b> Ferrule; Sleeve for 4 mm <sup>2</sup> / AWG 12; insulated; electro-tin plated; electrolytic copper; gastight crimped; acc. to DIN 46228, Part 4/09.90	<a href="http://www.wago.com/216-267">www.wago.com/216-267</a>
	<b>Item no.: 216-284</b> Ferrule; Sleeve for 1.5 mm <sup>2</sup> / AWG 16; insulated; electro-tin plated; electrolytic copper; gastight crimped; acc. to DIN 46228, Part 4/09.90	<a href="http://www.wago.com/216-284">www.wago.com/216-284</a>
	<b>Item no.: 216-286</b> Ferrule; Sleeve for 2.5 mm <sup>2</sup> / AWG 14; insulated; electro-tin plated; electrolytic copper; gastight crimped; acc. to DIN 46228, Part 4/09.90	<a href="http://www.wago.com/216-286">www.wago.com/216-286</a>
	<b>Item no.: 216-287</b> Ferrule; Sleeve for 4 mm <sup>2</sup> / AWG 12; insulated; electro-tin plated; electrolytic copper; gastight crimped; acc. to DIN 46228, Part 4/09.90	<a href="http://www.wago.com/216-287">www.wago.com/216-287</a>
	<b>Item no.: 216-288</b> Ferrule; Sleeve for 6 mm <sup>2</sup> / AWG 10; insulated; electro-tin plated; electrolytic copper; gastight crimped; acc. to DIN 46228, Part 4/09.90	<a href="http://www.wago.com/216-288">www.wago.com/216-288</a>
	<b>Item no.: 216-289</b> Ferrule; Sleeve for 10 mm <sup>2</sup> / AWG 8; insulated; electro-tin plated; electrolytic copper; gastight crimped; acc. to DIN 46228, Part 4/09.90	<a href="http://www.wago.com/216-289">www.wago.com/216-289</a>
	<b>Item no.: 216-301</b> Ferrule; Sleeve for 0.25 mm <sup>2</sup> / AWG 24; insulated; electro-tin plated	<a href="http://www.wago.com/216-301">www.wago.com/216-301</a>
	<b>Item no.: 216-302</b> Ferrule; Sleeve for 0.34 mm <sup>2</sup> / AWG 24; insulated; electro-tin plated	<a href="http://www.wago.com/216-302">www.wago.com/216-302</a>
	<b>Item no.: 216-321</b> Ferrule; Sleeve for 0.25 mm <sup>2</sup> / AWG 24; insulated; electro-tin plated	<a href="http://www.wago.com/216-321">www.wago.com/216-321</a>
	<b>Item no.: 216-322</b> Ferrule; Sleeve for 0.34 mm <sup>2</sup> / AWG 24; insulated; electro-tin plated	<a href="http://www.wago.com/216-322">www.wago.com/216-322</a>

## Downloads

## Documentation

## Bid Text

262-292

Oct 11, 2017

DOC  
25.1 kB

Download



Subject to changes.

---

WAGO Kontakttechnik GmbH & Co. KG  
Hansastr. 27  
32423 Minden  
Phone: +49571 887-0 | Fax: +49571 887-169  
Email: [info.de@wago.com](mailto:info.de@wago.com) | Web: [www.wago.com](http://www.wago.com)

Do you have any questions about our products?  
We are always happy to take your call at +49 (571) 887-44222.