

Data sheet | Item number: 264-286

4-conductor Ex e II terminal strip; with snap-in mounting feet; for plate thickness 0.6 - 1.2 mm; Fixing hole 3.5 mm Ø; also fits 210-154 aluminum rail or with 209-123 mounting carrier for DIN 35 rail; suitable for Ex e II applications; 6-pole

www.wago.com/264-286



RoHS Compliant

BOMcheck.net

Color: ■

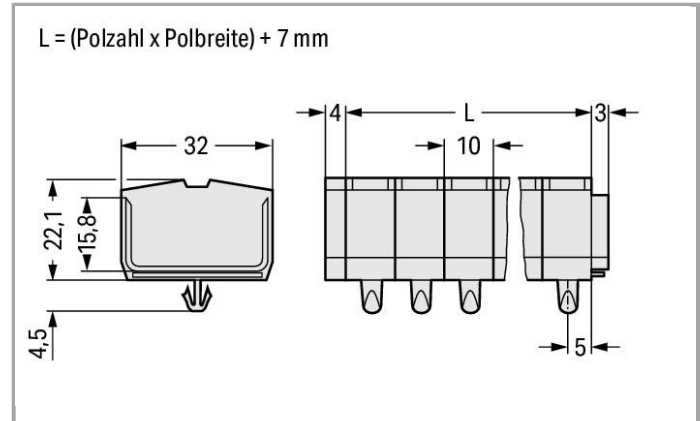

Data

Electrical data

Rated voltage EN (Ex e II) 690 V

Ratings per IEC/EN 60664-1

Rated current 23 A

Connection data

Connection technology	CAGE CLAMP®
Actuation type	Operating tool
Connectable conductor materials	Copper Aluminum
Solid conductor	0.08 ... 2.5 mm ² / 28 ... 12 AWG
Fine-stranded conductor	0.08 ... 2.5 mm ² / 28 ... 12 AWG
Strip length	8 ... 9 mm / 0.31 ... 0.35 Inch
No. of poles	6
Total number of connection points	24
Total number of potentials	6

Number of levels	1
Type of wiring	Front-entry wiring

Geometrical Data

Width	67 mm / 2.638 inch
Height from the surface	22.1 mm / 0.87 inch
Depth	32 mm / 1.26 inch

Mechanical data

Design	horizontal
Marking level	Center marking

Material Data



Color	light gray
Fire load	0.752 MJ
Weight	41 g

Commercial data

Country of origin	DE
GTIN	4044918415880
Customs Tariff No.	85369010000
Product Group	9 (Std. Chassis Mt. Blocks)

Approvals / Certificates

Ex-Approvals

Logo	Approval	Certificate name
	AEx UL International Germany GmbH c/o Physikalisch Technische Bundesanstalt	E185892
	ATEX Physikalisch Technische Bundesanstalt (PTB)	PTB 98 ATEX 3129 U (II 2 G/D EEx e II)
	IECEX Physikalisch Technische Bundesanstalt (PTB)	IECEX PTB 04.0003U (Ex e IIC Gb)

Country specific Approvals

Logo	Approval	Certificate name
	CSA DEKRA Certification B.V.	70010891



Ship Approvals

Logo	Approval	Certificate name
	LR Lloyds Register	91/20242 (E7)

UL-Approvals

Logo	Approval	Certificate name
	UR Underwriters Laboratories Inc.	E45172, sec. 6

Compatible products

assembling

	Item no.: 709-153 Cover; Type 1; suitable for cover carrier, type 1; 1 m long	www.wago.com/709-153
--	---	--





General accessories

	Item no.: 209-122 Plastic end stop; for WSB markers; for 210-154 aluminum rail	www.wago.com/209-122
--	--	--

check

	Item no.: 249-139 Test plug module; without locking device; modular; for 4-conductor terminal blocks	www.wago.com/249-139
--	--	--



















tools







	Item no.: 209-130 Operating tool; suitable for 264, 280 and 281 Series; 1-way; of insulating material	www.wago.com/209-130
	Item no.: 210-657 Operating tool with partially insulated shaft; Blade (3.5 x 0.5) mm; short	www.wago.com/210-657
	Item no.: 210-658 Operating tool with partially insulated shaft; Blade (3.5 x 0.5) mm; short; angled	www.wago.com/210-658
	Item no.: 210-720 Operating tool with partially insulated shaft; Type 2, blade (3.5 x 0.5) mm	www.wago.com/210-720
	Item no.: 280-432 Operating tool; of insulating material; 2-way	www.wago.com/280-432

Carrier rail









	Item no.: 210-154 Aluminum carrier rail; 1000 mm long; 18 mm wide; 7 mm high	www.wago.com/210-154
--	--	--

ferrule

	Item no.: 216-101 Ferrule; Sleeve for 0.5 mm ² / AWG 22; uninsulated; electro-tin plated	www.wago.com/216-101
	Item no.: 216-102 Ferrule; Sleeve for 0.75 mm ² / AWG 20; uninsulated; electro-tin plated	www.wago.com/216-102
	Item no.: 216-103 Ferrule; Sleeve for 1 mm ² / AWG 18; uninsulated; electro-tin plated	www.wago.com/216-103
	Item no.: 216-104 Ferrule; Sleeve for 1.5 mm ² / AWG 16; uninsulated; electro-tin plated	www.wago.com/216-104
	Item no.: 216-106 Ferrule; Sleeve for 2.5 mm ² / AWG 14; uninsulated; electro-tin plated	www.wago.com/216-106
	Item no.: 216-121 Ferrule; Sleeve for 0.5 mm ² / AWG 22; uninsulated; electro-tin plated	www.wago.com/216-121
	Item no.: 216-122 Ferrule; Sleeve for 0.75 mm ² / AWG 20; uninsulated; electro-tin plated	www.wago.com/216-122
	Item no.: 216-123 Ferrule; Sleeve for 1 mm ² / AWG 18; uninsulated; electro-tin plated	www.wago.com/216-123
	Item no.: 216-124 Ferrule; Sleeve for 1.5 mm ² / AWG 16; uninsulated; electro-tin plated	www.wago.com/216-124
	Item no.: 216-131 Ferrule; Sleeve for 0.25 mm ² / AWG 24; uninsulated; electro-tin plated	www.wago.com/216-131
	Item no.: 216-132 Ferrule; Sleeve for 0.34 mm ² / AWG 24; uninsulated; electro-tin plated	www.wago.com/216-132
	Item no.: 216-151 Ferrule; Sleeve for 0.25 mm ² / AWG 24; uninsulated; electro-tin plated	www.wago.com/216-151
	Item no.: 216-152 Ferrule; Sleeve for 0.34 mm ² / AWG 24; uninsulated; electro-tin plated	www.wago.com/216-152
	Item no.: 216-201 Ferrule; Sleeve for 0.5 mm ² / AWG 22; insulated; electro-tin plated	www.wago.com/216-201
	Item no.: 216-202 Ferrule; Sleeve for 0.75 mm ² / AWG 20; insulated; electro-tin plated	www.wago.com/216-202
	Item no.: 216-203 Ferrule; Sleeve for 1 mm ² / AWG 18; insulated; electro-tin plated	www.wago.com/216-203
	Item no.: 216-204 Ferrule; Sleeve for 1.5 mm ² / AWG 16; insulated; electro-tin plated	www.wago.com/216-204
	Item no.: 216-205 Ferrule; Sleeve for 2.08 mm ² / AWG 14; insulated; electro-tin plated	www.wago.com/216-205

	Item no.: 216-206 Ferrule; Sleeve for 2.5 mm ² / AWG 14; insulated; electro-tin plated	www.wago.com/216-206
	Item no.: 216-221 Ferrule; Sleeve for 0.5 mm ² / AWG 22; insulated; electro-tin plated	www.wago.com/216-221
	Item no.: 216-222 Ferrule; Sleeve for 0.75 mm ² / AWG 20; insulated; electro-tin plated	www.wago.com/216-222
	Item no.: 216-223 Ferrule; Sleeve for 1 mm ² / AWG 18; insulated; electro-tin plated	www.wago.com/216-223
	Item no.: 216-224 Ferrule; Sleeve for 1.5 mm ² / AWG 16; insulated; electro-tin plated	www.wago.com/216-224
	Item no.: 216-321 Ferrule; Sleeve for 0.25 mm ² / AWG 24; insulated; electro-tin plated	www.wago.com/216-321
	Item no.: 216-322 Ferrule; Sleeve for 0.34 mm ² / AWG 24; insulated; electro-tin plated	www.wago.com/216-322

Marking accessories

	Item no.: 2009-145 Mini-WSB Inline; for smartPRINTER; on reel; stretchable 5 - 5.2 mm; plain; snap-on type	www.wago.com/2009-145
	Item no.: 2009-145/000-002 Mini-WSB Inline; for smartPRINTER; on reel; stretchable 5 - 5.2 mm; plain; snap-on type	www.wago.com/2009-145/000-002
	Item no.: 2009-145/000-005 Mini-WSB Inline; for smartPRINTER; on reel; stretchable 5 - 5.2 mm; plain; snap-on type	www.wago.com/2009-145/000-005
	Item no.: 2009-145/000-006 Mini-WSB Inline; for smartPRINTER; on reel; stretchable 5 - 5.2 mm; plain; snap-on type	www.wago.com/2009-145/000-006
	Item no.: 2009-145/000-007 Mini-WSB Inline; for smartPRINTER; on reel; stretchable 5 - 5.2 mm; plain; snap-on type	www.wago.com/2009-145/000-007
	Item no.: 2009-145/000-012 Mini-WSB Inline; for smartPRINTER; on reel; stretchable 5 - 5.2 mm; plain; snap-on type	www.wago.com/2009-145/000-012
	Item no.: 2009-145/000-023 Mini-WSB Inline; for smartPRINTER; on reel; stretchable 5 - 5.2 mm; plain; snap-on type	www.wago.com/2009-145/000-023
	Item no.: 2009-145/000-024 Mini-WSB Inline; on reel; stretchable 5 - 5.2 mm; plain; snap-on type	www.wago.com/2009-145/000-024
	Item no.: 209-290 Marker tags; not stretchable; plain; snap-on type	www.wago.com/209-290

Item no.: 248-501



Miniature WSB Quick marking system; plain; Marker width 5 mm; 10 strips with 10 markers per card www.wago.com/248-501



Item no.: 248-501/000-002
Mini-WSB marking card; as card; not stretchable; plain; snap-on type

www.wago.com/248-501/000-002



Item no.: 248-501/000-005
Mini-WSB marking card; as card; plain; snap-on type

www.wago.com/248-501/000-005



Item no.: 248-501/000-006
Mini-WSB marking card; as card; not stretchable; plain; snap-on type

www.wago.com/248-501/000-006



Item no.: 248-501/000-007
Mini-WSB marking card; as card; not stretchable; plain; snap-on type

www.wago.com/248-501/000-007



Item no.: 248-501/000-012
Mini-WSB marking card; as card; not stretchable; plain; snap-on type

www.wago.com/248-501/000-012



Item no.: 248-501/000-017
Mini-WSB marking card; as card; not stretchable; plain; snap-on type

www.wago.com/248-501/000-017



Item no.: 248-501/000-023
Mini-WSB marking card; as card; not stretchable; plain; snap-on type

www.wago.com/248-501/000-023



Item no.: 248-501/000-024
Mini-WSB marking card; as card; not stretchable; plain; snap-on type

www.wago.com/248-501/000-024

Jumper



Item no.: 264-402
Comb-style jumper bar; insulated; 2-way; reduces conductor size to 1.5 mm

www.wago.com/264-402



Item no.: 280-492
Alternate comb-style jumper bar; insulated; 2-way; IN = IN terminal block

www.wago.com/280-492

Downloads

Documentation

Bid Text

264-286

Oct 11, 2017

DOC
25.6 kB

Download

smartDATA

CAD data



3D Download 264-286

URL

Download

Subject to changes.

WAGO Kontakttechnik GmbH & Co. KG
Hansastr. 27
32423 Minden
Phone: +49571 887-0 | Fax: +49571 887-169
Email: info.de@wago.com | Web: www.wago.com

Do you have any questions about our products?
We are always happy to take your call at +49 (571) 887-44222.