

Data sheet | Item number: 280-561

3-conductor sensor terminal block; for component plugs; with colored conductor entries; 2.5 mm²; CAGE CLAMP®

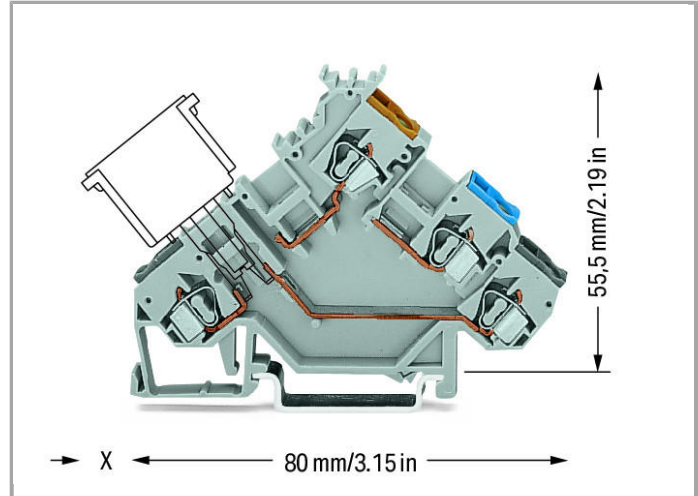

www.wago.com/280-561

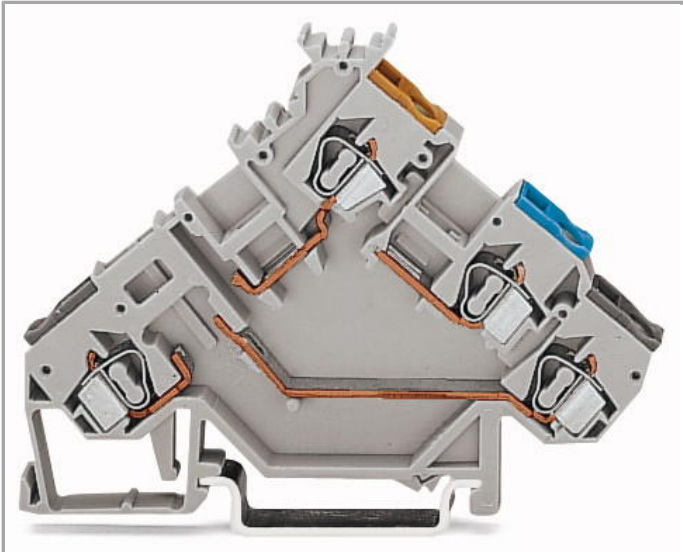

RoHS Compliant

[BOMcheck.net](https://www.bomcheck.net)

Color: ■

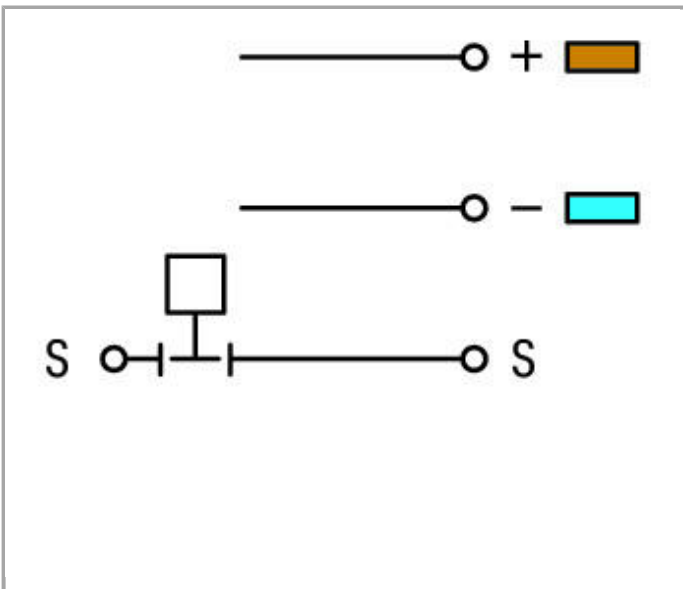

Data
Electrical data



Ratings per IEC/EN 60664-1

Rated voltage (III / 3)	250 V
Rated impulse voltage (III / 3)	4 kV
Rated current	6 A
Legend (ratings)	(III / 3) $\hat{=}$ Overvoltage category III / Pollution degree 3

Connection data

Connection technology	CAGE CLAMP®
Actuation type	Operating tool
Connectable conductor materials	Copper Aluminum
Solid conductor	0.08 ... 2.5 mm ² / 28 ... 12 AWG
Fine-stranded conductor	0.08 ... 2.5 mm ² / 28 ... 12 AWG
Strip length	8 ... 9 mm / 0.31 ... 0.35 Inch
Total number of connection points	4
Total number of potentials	4
Number of levels	3
Type of wiring	Front-entry wiring

Geometrical Data

Width	5 mm / 0.197 inch
Height from upper-edge of DIN-35 rail	55.5 mm / 2.185 inch
Depth	80 mm / 3.15 inch

Mechanical data

Design	angled
Type of mounting	DIN-35 rail
Marking level	Center marking

Material Data

Color	gray
Insulating material	Polyamide 66 (PA 66)
Fire load	0.181 MJ
Weight	10.489 g

Commercial data

Country of origin	DE
GTIN	4044918890199
Customs Tariff No.	85369010000

Product Group

1 (Rail Mounted Terminal Blocks)

Approvals / Certificates

Country specific Approvals

Logo	Approval	Certificate name
	CCA DEKRA Certification B.V.	2160584.53

Ship Approvals









Logo	Approval	Certificate name
	ABS American Bureau of Shipping	14-HG1293677-PDA















UL-Approvals

Logo	Approval	Certificate name
	UR Underwriters Laboratories Inc.	E45172

Compatible products

ferrule

	Item no.: 216-101 Ferrule; Sleeve for 0.5 mm ² / AWG 22; uninsulated; electro-tin plated	www.wago.com/216-101
	Item no.: 216-102 Ferrule; Sleeve for 0.75 mm ² / AWG 20; uninsulated; electro-tin plated	www.wago.com/216-102
	Item no.: 216-103 Ferrule; Sleeve for 1 mm ² / AWG 18; uninsulated; electro-tin plated	www.wago.com/216-103
	Item no.: 216-104 Ferrule; Sleeve for 1.5 mm ² / AWG 16; uninsulated; electro-tin plated	www.wago.com/216-104
	Item no.: 216-201 Ferrule; Sleeve for 0.5 mm ² / AWG 22; insulated; electro-tin plated	www.wago.com/216-201
	Item no.: 216-202 Ferrule; Sleeve for 0.75 mm ² / AWG 20; insulated; electro-tin plated	www.wago.com/216-202
	Item no.: 216-203 Ferrule; Sleeve for 1 mm ² / AWG 18; insulated; electro-tin plated	www.wago.com/216-203
	Item no.: 216-204 Ferrule; Sleeve for 1.5 mm ² / AWG 16; insulated; electro-tin plated	www.wago.com/216-204

	<p>Item no.: 216-301 Ferrule; Sleeve for 0.25 mm² / AWG 24; insulated; electro-tin plated</p>	www.wago.com/216-301
	<p>Item no.: 216-302 Ferrule; Sleeve for 0.34 mm² / AWG 24; insulated; electro-tin plated</p>	www.wago.com/216-302
Marking accessories		
	<p>Item no.: 2009-115 WMB-Inline; for smartPRINTER; on reel; stretchable 5 - 5.2 mm; plain; snap-on type</p>	www.wago.com/2009-115
	<p>Item no.: 2009-115/000-002 WMB-Inline; for smartPRINTER; on reel; stretchable 5 - 5.2 mm; plain; snap-on type</p>	www.wago.com/2009-115/000-002
	<p>Item no.: 2009-115/000-006 WMB-Inline; for smartPRINTER; on reel; stretchable 5 - 5.2 mm; plain; snap-on type</p>	www.wago.com/2009-115/000-006
	<p>Item no.: 2009-115/000-007 WMB-Inline; for smartPRINTER; on reel; stretchable 5 - 5.2 mm; plain; snap-on type</p>	www.wago.com/2009-115/000-007
	<p>Item no.: 2009-115/000-012 WMB-Inline; for smartPRINTER; on reel; stretchable 5 - 5.2 mm; plain; snap-on type</p>	www.wago.com/2009-115/000-012
	<p>Item no.: 2009-115/000-017 WMB-Inline; for smartPRINTER; on reel; stretchable 5 - 5.2 mm; plain; snap-on type</p>	www.wago.com/2009-115/000-017
	<p>Item no.: 2009-115/000-023 WMB-Inline; for smartPRINTER; on reel; stretchable 5 - 5.2 mm; plain; snap-on type</p>	www.wago.com/2009-115/000-023
	<p>Item no.: 2009-115/000-024 WMB-Inline; for smartPRINTER; on reel; stretchable 5 - 5.2 mm; plain; snap-on type</p>	www.wago.com/2009-115/000-024
	<p>Item no.: 793-501 WMB marking card; as card; not stretchable; plain; snap-on type</p>	www.wago.com/793-501
	<p>Item no.: 793-501/000-002 WMB marking card; as card; not stretchable; plain; snap-on type</p>	www.wago.com/793-501/000-002
	<p>Item no.: 793-501/000-005 WMB marking card; as card; not stretchable; plain; snap-on type</p>	www.wago.com/793-501/000-005
	<p>Item no.: 793-501/000-006 WMB marking card; as card; not stretchable; plain; snap-on type</p>	www.wago.com/793-501/000-006
	<p>Item no.: 793-501/000-007 WMB marking card; as card; not stretchable; plain; snap-on type</p>	www.wago.com/793-501/000-007



Item no.: 793-501/000-012
WMB marking card; as card; not stretchable; plain; snap-on type

www.wago.com/793-501/000-012



Item no.: 793-501/000-017
WMB marking card; as card; not stretchable; plain; snap-on type

www.wago.com/793-501/000-017



Item no.: 793-501/000-023
WMB marking card; as card; not stretchable; plain; snap-on type

www.wago.com/793-501/000-023



Item no.: 793-501/000-024
WMB marking card; as card; not stretchable; plain; snap-on type

www.wago.com/793-501/000-024



Item no.: 793-5501
WMB marking card; as card; for terminal block width 5 - 17.5 mm; stretchable 5 - 5.2 mm; plain; snap-on type

www.wago.com/793-5501



Item no.: 793-5501/000-002
WMB marking card; as card; for terminal block width 5 - 17.5 mm; stretchable 5 - 5.2 mm; plain; snap-on type

www.wago.com/793-5501/000-002



Item no.: 793-5501/000-005
WMB marking card; as card; stretchable 5 - 5.2 mm; plain; snap-on type

www.wago.com/793-5501/000-005



Item no.: 793-5501/000-006
WMB marking card; as card; stretchable 5 - 5.2 mm; plain; snap-on type

www.wago.com/793-5501/000-006



Item no.: 793-5501/000-007
WMB marking card; as card; stretchable 5 - 5.2 mm; plain; snap-on type

www.wago.com/793-5501/000-007



Item no.: 793-5501/000-012
WMB marking card; as card; stretchable 5 - 5.2 mm; plain; snap-on type

www.wago.com/793-5501/000-012



Item no.: 793-5501/000-017
WMB marking card; as card; stretchable 5 - 5.2 mm; plain; snap-on type

www.wago.com/793-5501/000-017



Item no.: 793-5501/000-023
WMB marking card; as card; stretchable 5 - 5.2 mm; plain; snap-on type

www.wago.com/793-5501/000-023



Item no.: 793-5501/000-024
WMB marking card; as card; stretchable 5 - 5.2 mm; plain; snap-on type

www.wago.com/793-5501/000-024

General accessories

















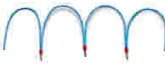

Item no.: 280-801
Empty component plug housing; 5 mm wide; 2-pole; Type 1

www.wago.com/280-801



Item no.: 281-511
Fuse plug with pull-tab; for miniature metric fuses 5 x 20 mm and 5 x 25 mm; 6 mm wide

www.wago.com/281-511

	<p>Item no.: 281-512 Fuse plug with pull-tab; for miniature metric fuses 5 x 20 mm and 5 x 25 mm; with hole for one led (for self-assembly); 6 mm wide</p>	www.wago.com/281-512
	<p>Item no.: 281-512/281-417 Fuse plug with pull-tab; for miniature metric fuses 5 x 20 mm and 5 x 25 mm; with neon lamp, 230 V AC/DC; 6 mm wide</p>	www.wago.com/281-512/281-417
	<p>Item no.: 281-512/281-418 Fuse plug with pull-tab; for miniature metric fuses 5 x 20 mm and 5 x 25 mm; with neon lamp, 120 V AC/DC; 6 mm wide</p>	www.wago.com/281-512/281-418
	<p>Item no.: 281-512/281-501 Fuse plug with pull-tab; for miniature metric fuses 5 x 20 mm and 5 x 25 mm; with LED indicator; 24 V AC/DC; 6 mm wide</p>	www.wago.com/281-512/281-501
Jumper		
	<p>Item no.: 210-103 Wire commoning chain; insulated; 50 connections</p>	www.wago.com/210-103
	<p>Item no.: 210-123 Wire commoning chain; insulated; 50 connections</p>	www.wago.com/210-123
	<p>Item no.: 249-123 Push-in type wire jumper; insulated; wire length 180 mm; Conductor cross section 0.75 mm²</p>	www.wago.com/249-123
	<p>Item no.: 249-125 Push-in type wire jumper; insulated; wire length 60 mm; Conductor cross section 0.75 mm²</p>	www.wago.com/249-125
	<p>Item no.: 249-126 Push-in type wire jumper; insulated; wire length 110 mm; Conductor cross section 0.75 mm²</p>	www.wago.com/249-126
	<p>Item no.: 249-127 Push-in type wire jumper; insulated; wire length 250 mm; Conductor cross section 0.75 mm²</p>	www.wago.com/249-127
	<p>Item no.: 280-402 Adjacent jumper; insulated; IN = IN terminal block</p>	www.wago.com/280-402
	<p>Item no.: 280-482 Comb-style jumper bar; insulated; 2-way; IN = IN terminal block</p>	www.wago.com/280-482
	<p>Item no.: 280-483 Comb-style jumper bar; insulated; 3-way; IN = IN terminal block</p>	www.wago.com/280-483
	<p>Item no.: 280-484 Comb-style jumper bar; insulated; 4-way; IN = IN terminal block</p>	www.wago.com/280-484
	<p>Item no.: 280-485 Comb-style jumper bar; insulated; 5-way; IN = IN terminal block</p>	www.wago.com/280-485
	<p>Item no.: 280-490 Comb-style jumper bar; insulated; 10-way; IN = IN terminal block</p>	www.wago.com/280-490
	<p>Item no.: 280-492 Alternate comb-style jumper bar; insulated; 2-way; IN = IN terminal block</p>	www.wago.com/280-492
	<p>Item no.: 709-110 Wire commoning chain; insulated; 4 connections; 3 x 110 mm</p>	www.wago.com/709-110



Item no.: 709-111
Wire commoning chain; insulated; 3 connections; 2 x 120 mm

www.wago.com/709-111



Item no.: 709-112
Wire commoning chain; insulated; 3 connections; 2 x 170 mm

www.wago.com/709-112



Item no.: 780-452
Staggered jumper; insulated; from 1 to 2; Spacing: 5 mm; suitable for 2-conductor female plugs

www.wago.com/780-452



Item no.: 780-453
Staggered jumper; insulated; from 1 to 3; Spacing: 5 mm; suitable for 2-conductor female plugs

www.wago.com/780-453



Item no.: 780-454
Staggered jumper; insulated; from 1 to 4; Spacing: 5 mm; suitable for 2-conductor female plugs

www.wago.com/780-454



Item no.: 780-455
Staggered jumper; insulated; from 1 to 5; Spacing: 5 mm; suitable for 2-conductor female plugs

www.wago.com/780-455



Item no.: 780-456
Staggered jumper; insulated; from 1 to 6; Spacing: 5 mm; suitable for 2-conductor female plugs

www.wago.com/780-456



Item no.: 780-457
Staggered jumper; insulated; from 1 to 7; Spacing: 5 mm; suitable for 2-conductor female plugs

www.wago.com/780-457



Item no.: 780-458
Staggered jumper; insulated; from 1 to 8; Spacing: 5 mm; suitable for 2-conductor female plugs

www.wago.com/780-458

Protective Warning Marker



Item no.: 280-415
Protective warning marker; with high-voltage symbol, black; for 5 terminal blocks

www.wago.com/280-415

assembling



Item no.: 709-154
Cover; Type 2; suitable for cover carrier, type 2; 1 m long

www.wago.com/709-154

Insulation stop



Item no.: 280-470
Insulation stop; 0.08 - 0.2 mm² "s" (0.14 mm² "f-st"); 5 pieces/strip

www.wago.com/280-470



Item no.: 280-471
Insulation stop; 0.25 - 0.5 mm²; 5 pieces/strip

www.wago.com/280-471



Item no.: 280-472
Insulation stop; 0.75 - 1 mm²; 5 pieces/strip

www.wago.com/280-472

Carrier rail



Item no.: 210-112
Steel carrier rail; 35 x 7.5 mm; 1 mm thick; 2 m long; slotted; according to EN 60715; "Hole width 25 mm"

www.wago.com/210-112











Item no.: 210-113
Steel carrier rail; 35 x 7.5 mm; 1 mm thick; 2 m long; unslotted; according to EN 60715

www.wago.com/210-113





Item no.: 210-114
Steel carrier rail; 35 x 15 mm; 1.5 mm thick; 2 m long; unslotted; similar to EN 60715







www.wago.com/210-114













	Item no.: 210-115 Steel carrier rail; 35 x 7.5 mm; 1 mm thick; 2 m long; slotted; according to EN 60715; "Hole width 18 mm	www.wago.com/210-115
	Item no.: 210-118 Steel carrier rail; 35 x 15 mm; 2.3 mm thick; 2 m long; unslotted; according to EN 60715	www.wago.com/210-118
	Item no.: 210-196 Aluminum carrier rail; 35 x 8.2 mm; 1.6 mm thick; 2 m long; unslotted; similar to EN 60715	www.wago.com/210-196
	Item no.: 210-197 Steel carrier rail; 35 x 15 mm; 1.5 mm thick; 2 m long; slotted; similar to EN 60715	www.wago.com/210-197
	Item no.: 210-198 Copper carrier rail; 35 x 15 mm; 2.3 mm thick; 2 m long; unslotted; according to EN 60715	www.wago.com/210-198
	Item no.: 210-504 Steel carrier rail; 35 x 7.5 mm; 1 mm thick; 2 m long; slotted; galvanized; according to EN 60715	www.wago.com/210-504
	Item no.: 210-505 Steel carrier rail; 35 x 7.5 mm; 1 mm thick; 2 m long; unslotted; galvanized; according to EN 60715	www.wago.com/210-505
	Item no.: 210-506 Steel carrier rail; 35 x 15 mm; 1.5 mm thick; 2 m long; unslotted; galvanized; similar to EN 60715	www.wago.com/210-506
	Item no.: 210-508 Steel carrier rail; 35 x 15 mm; 1.5 mm thick; 2 m long; slotted; galvanized; similar to EN 60715	www.wago.com/210-508

End plate

	Item no.: 280-319 End and intermediate plate; 1 mm thick; for triple-deck terminal blocks	www.wago.com/280-319
	Item no.: 280-321 End and intermediate plate; 1 mm thick; for triple-deck terminal blocks	www.wago.com/280-321

plug

	Item no.: 280-850 Fuse plug; 5 mm wide; with soldered miniature fuse; 250 mA FF	www.wago.com/280-850
	Item no.: 280-850/281-413 Fuse plug; 5 mm wide; with soldered miniature fuse; with additional indicator lamp; red LED; DC 15 - 30 V; 250 mA FF	www.wago.com/280-850/281-413
	Item no.: 280-850/281-414 Fuse plug; 5 mm wide; with soldered miniature fuse; with additional indicator lamp; red LED; DC 30 - 65 V; 250 mA FF	www.wago.com/280-850/281-414
	Item no.: 280-850/281-415 Fuse plug; 5 mm wide; with soldered miniature fuse; with additional indicator lamp; red LED; AC 15 - 30 V; 250 mA FF	www.wago.com/280-850/281-415
	Item no.: 280-852 Fuse plug; 5 mm wide; with soldered miniature fuse; 500 mA FF	www.wago.com/280-852
	Item no.: 280-852/281-413 Fuse plug; 5 mm wide; with soldered miniature fuse; with additional indicator lamp; red LED; DC 15 - 30 V; 500 mA FF	www.wago.com/280-852/281-413

	Item no.: 280-852/281-414 Fuse plug; 5 mm wide; with soldered miniature fuse; with additional indicator lamp; red LED; DC 30 - 65 V; 500 mA FF	www.wago.com/280-852/281-414
	Item no.: 280-852/281-415 Fuse plug; 5 mm wide; with soldered miniature fuse; with additional indicator lamp; red LED; AC 15 - 30 V; 500 mA FF	www.wago.com/280-852/281-415
	Item no.: 280-854 Fuse plug; 5 mm wide; with soldered miniature fuse; 1 A FF	www.wago.com/280-854
	Item no.: 280-854/281-413 Fuse plug; 5 mm wide; with soldered miniature fuse; with additional indicator lamp; red LED; DC 15 - 30 V; 1 A FF	www.wago.com/280-854/281-413
	Item no.: 280-854/281-414 Fuse plug; 5 mm wide; with soldered miniature fuse; with additional indicator lamp; red LED; DC 30 - 65 V; 1 A FF	www.wago.com/280-854/281-414
	Item no.: 280-854/281-415 Fuse plug; 5 mm wide; with soldered miniature fuse; with additional indicator lamp; red LED; AC 15 - 30 V; 1 A FF	www.wago.com/280-854/281-415
	Item no.: 280-856 Fuse plug; 5 mm wide; with soldered miniature fuse; 2 A FF	www.wago.com/280-856
	Item no.: 280-856/281-413 Fuse plug; 5 mm wide; with soldered miniature fuse; with additional indicator lamp; red LED; DC 15 - 30 V; 2 A FF	www.wago.com/280-856/281-413
	Item no.: 280-856/281-414 Fuse plug; 5 mm wide; with soldered miniature fuse; with additional indicator lamp; red LED; DC 30 - 65 V; 2 A FF	www.wago.com/280-856/281-414
	Item no.: 280-856/281-415 Fuse plug; 5 mm wide; with soldered miniature fuse; with additional indicator lamp; red LED; AC 15 - 30 V; 2 A FF	www.wago.com/280-856/281-415
tools		
	Item no.: 210-657 Operating tool with partially insulated shaft; Blade (3.5 x 0.5) mm; short	www.wago.com/210-657
	Item no.: 210-658 Operating tool with partially insulated shaft; Blade (3.5 x 0.5) mm; short; angled	www.wago.com/210-658
	Item no.: 210-720 Operating tool with partially insulated shaft; Type 2, blade (3.5 x 0.5) mm	www.wago.com/210-720

Downloads**Documentation****Bid Text**

280-561

Oct 12, 2017

DOC

Download



Subject to changes.