

Data sheet | Item number: 280-565/280-319

2-conductor actuator terminal block; with colored conductor entries; 2.5 mm<sup>2</sup>; CAGE CLAMP®

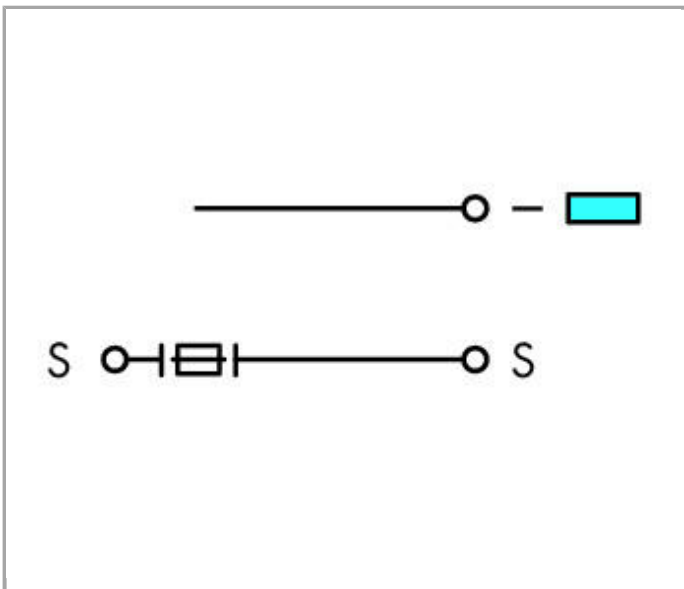

[www.wago.com/280-565/280-319](http://www.wago.com/280-565/280-319)

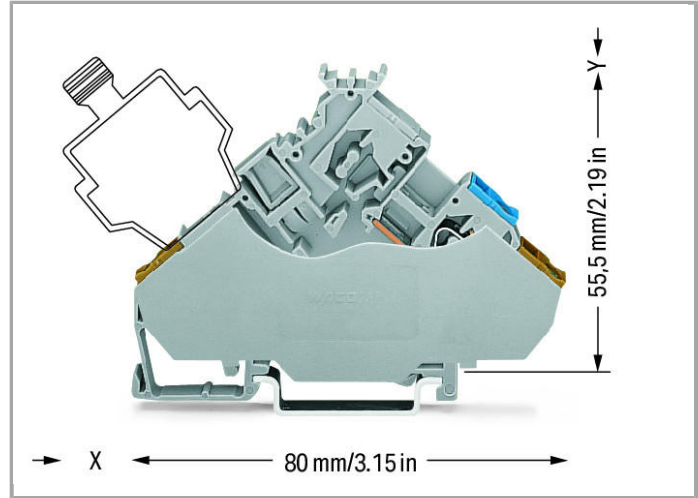
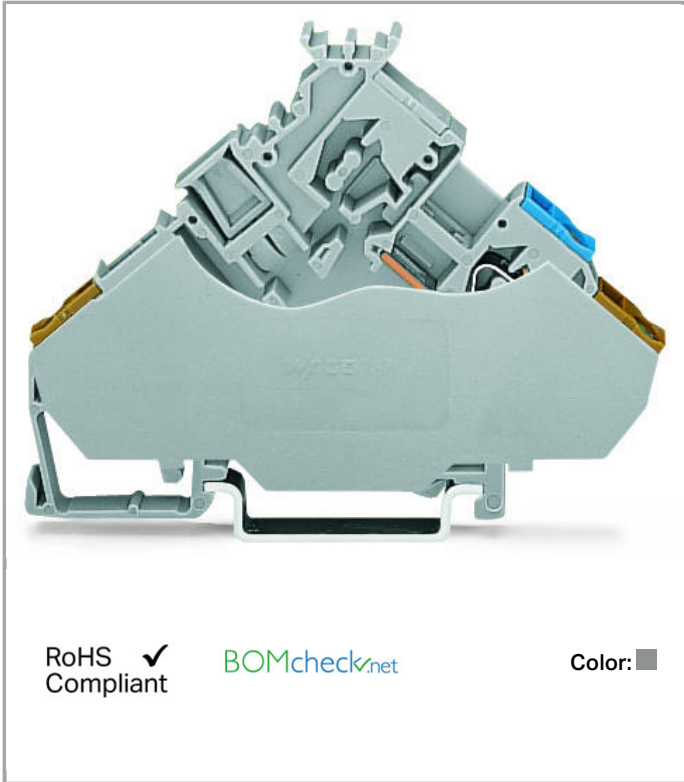

Data  
Electrical data



### Ratings per IEC/EN 60664-1

Rated voltage (III / 3)	125 V
Rated current	5 A
Rated voltage (III / 3) 2	250 V
Rated current (2)	6.3 A
Legend (ratings)	(III / 3) ≙ Overvoltage category III / Pollution degree 3

### Connection data

Connection technology	CAGE CLAMP®
Actuation type	Operating tool
Connectable conductor materials	Copper Aluminum
Solid conductor	0.08 ... 2.5 mm <sup>2</sup> / 28 ... 12 AWG
Fine-stranded conductor	0.08 ... 2.5 mm <sup>2</sup> / 28 ... 12 AWG
Strip length	8 ... 9 mm / 0.31 ... 0.35 Inch
Total number of connection points	3
Total number of potentials	2
Number of levels	3
Type of wiring	Front-entry wiring

### Geometrical Data

Width	6 mm / 0.236 inch
Height from upper-edge of DIN-35 rail	55.5 mm / 2.185 inch
Depth	80 mm / 3.15 inch

### Mechanical data

Design	angled
Type of mounting	DIN-35 rail
Marking level	Center marking

### Material Data

Color	gray
Insulating material	Polyamide 66 (PA 66)
Fire load	0.268 MJ
Weight	12.524 g

### Commercial data

Country of origin	DE
GTIN	4044918890229

Customs Tariff No.

85369010000

Product Group

1 (Rail Mounted Terminal Blocks)

## Approvals / Certificates

### Country specific Approvals

Logo	Approval	Certificate name
	CCA DEKRA Certification B.V.	2160584.53

### Ship Approvals







Logo	Approval	Certificate name
	ABS American Bureau of Shipping	14-HG1293677-PDA















### UL-Approvals

Logo	Approval	Certificate name
	UR Underwriters Laboratories Inc.	E45172

## Compatible products

### Marking accessories

	Item no.: 2009-115 WMB-Inline; for smartPRINTER; on reel; stretchable 5 - 5.2 mm; plain; snap-on type	<a href="http://www.wago.com/2009-115">www.wago.com/2009-115</a>
	Item no.: 2009-115/000-002 WMB-Inline; for smartPRINTER; on reel; stretchable 5 - 5.2 mm; plain; snap-on type	<a href="http://www.wago.com/2009-115/000-002">www.wago.com/2009-115/000-002</a>
	Item no.: 2009-115/000-006 WMB-Inline; for smartPRINTER; on reel; stretchable 5 - 5.2 mm; plain; snap-on type	<a href="http://www.wago.com/2009-115/000-006">www.wago.com/2009-115/000-006</a>
	Item no.: 2009-115/000-007 WMB-Inline; for smartPRINTER; on reel; stretchable 5 - 5.2 mm; plain; snap-on type	<a href="http://www.wago.com/2009-115/000-007">www.wago.com/2009-115/000-007</a>
	Item no.: 2009-115/000-012 WMB-Inline; for smartPRINTER; on reel; stretchable 5 - 5.2 mm; plain; snap-on type	<a href="http://www.wago.com/2009-115/000-012">www.wago.com/2009-115/000-012</a>
	Item no.: 2009-115/000-017 WMB-Inline; for smartPRINTER; on reel; stretchable 5 - 5.2 mm; plain; snap-on type	<a href="http://www.wago.com/2009-115/000-017">www.wago.com/2009-115/000-017</a>

	<p><b>Item no.: 2009-115/000-023</b> WMB-Inline; for smartPRINTER; on reel; stretchable 5 - 5.2 mm; plain; snap-on type</p>	<a href="http://www.wago.com/2009-115/000-023">www.wago.com/2009-115/000-023</a>
	<p><b>Item no.: 2009-115/000-024</b> WMB-Inline; for smartPRINTER; on reel; stretchable 5 - 5.2 mm; plain; snap-on type</p>	<a href="http://www.wago.com/2009-115/000-024">www.wago.com/2009-115/000-024</a>
	<p><b>Item no.: 793-501</b> WMB marking card; as card; not stretchable; plain; snap-on type</p>	<a href="http://www.wago.com/793-501">www.wago.com/793-501</a>
	<p><b>Item no.: 793-501/000-002</b> WMB marking card; as card; not stretchable; plain; snap-on type</p>	<a href="http://www.wago.com/793-501/000-002">www.wago.com/793-501/000-002</a>
	<p><b>Item no.: 793-501/000-005</b> WMB marking card; as card; not stretchable; plain; snap-on type</p>	<a href="http://www.wago.com/793-501/000-005">www.wago.com/793-501/000-005</a>
	<p><b>Item no.: 793-501/000-006</b> WMB marking card; as card; not stretchable; plain; snap-on type</p>	<a href="http://www.wago.com/793-501/000-006">www.wago.com/793-501/000-006</a>
	<p><b>Item no.: 793-501/000-007</b> WMB marking card; as card; not stretchable; plain; snap-on type</p>	<a href="http://www.wago.com/793-501/000-007">www.wago.com/793-501/000-007</a>
	<p><b>Item no.: 793-501/000-012</b> WMB marking card; as card; not stretchable; plain; snap-on type</p>	<a href="http://www.wago.com/793-501/000-012">www.wago.com/793-501/000-012</a>
	<p><b>Item no.: 793-501/000-017</b> WMB marking card; as card; not stretchable; plain; snap-on type</p>	<a href="http://www.wago.com/793-501/000-017">www.wago.com/793-501/000-017</a>
	<p><b>Item no.: 793-501/000-023</b> WMB marking card; as card; not stretchable; plain; snap-on type</p>	<a href="http://www.wago.com/793-501/000-023">www.wago.com/793-501/000-023</a>
	<p><b>Item no.: 793-501/000-024</b> WMB marking card; as card; not stretchable; plain; snap-on type</p>	<a href="http://www.wago.com/793-501/000-024">www.wago.com/793-501/000-024</a>
	<p><b>Item no.: 793-5501</b> WMB marking card; as card; for terminal block width 5 - 17.5 mm; stretchable 5 - 5.2 mm; plain; snap-on type</p>	<a href="http://www.wago.com/793-5501">www.wago.com/793-5501</a>
	<p><b>Item no.: 793-5501/000-002</b> WMB marking card; as card; for terminal block width 5 - 17.5 mm; stretchable 5 - 5.2 mm; plain; snap-on type</p>	<a href="http://www.wago.com/793-5501/000-002">www.wago.com/793-5501/000-002</a>
	<p><b>Item no.: 793-5501/000-005</b> WMB marking card; as card; stretchable 5 - 5.2 mm; plain; snap-on type</p>	<a href="http://www.wago.com/793-5501/000-005">www.wago.com/793-5501/000-005</a>
	<p><b>Item no.: 793-5501/000-006</b> WMB marking card; as card; stretchable 5 - 5.2 mm; plain; snap-on type</p>	<a href="http://www.wago.com/793-5501/000-006">www.wago.com/793-5501/000-006</a>



**Item no.: 793-5501/000-007**  
WMB marking card; as card; stretchable 5 - 5.2 mm; plain; snap-on type

[www.wago.com/793-5501/000-007](http://www.wago.com/793-5501/000-007)



**Item no.: 793-5501/000-012**  
WMB marking card; as card; stretchable 5 - 5.2 mm; plain; snap-on type

[www.wago.com/793-5501/000-012](http://www.wago.com/793-5501/000-012)



**Item no.: 793-5501/000-017**  
WMB marking card; as card; stretchable 5 - 5.2 mm; plain; snap-on type

[www.wago.com/793-5501/000-017](http://www.wago.com/793-5501/000-017)



**Item no.: 793-5501/000-023**  
WMB marking card; as card; stretchable 5 - 5.2 mm; plain; snap-on type

[www.wago.com/793-5501/000-023](http://www.wago.com/793-5501/000-023)



**Item no.: 793-5501/000-024**  
WMB marking card; as card; stretchable 5 - 5.2 mm; plain; snap-on type

[www.wago.com/793-5501/000-024](http://www.wago.com/793-5501/000-024)

## plug



**Item no.: 280-850**  
Fuse plug; 5 mm wide; with soldered miniature fuse; 250 mA FF

[www.wago.com/280-850](http://www.wago.com/280-850)



**Item no.: 280-850/281-413**  
Fuse plug; 5 mm wide; with soldered miniature fuse; with additional indicator lamp; red LED; DC 15 - 30 V; 250 mA FF

[www.wago.com/280-850/281-413](http://www.wago.com/280-850/281-413)



**Item no.: 280-850/281-414**  
Fuse plug; 5 mm wide; with soldered miniature fuse; with additional indicator lamp; red LED; DC 30 - 65 V; 250 mA FF

[www.wago.com/280-850/281-414](http://www.wago.com/280-850/281-414)



**Item no.: 280-850/281-415**  
Fuse plug; 5 mm wide; with soldered miniature fuse; with additional indicator lamp; red LED; AC 15 - 30 V; 250 mA FF

[www.wago.com/280-850/281-415](http://www.wago.com/280-850/281-415)



**Item no.: 280-852**  
Fuse plug; 5 mm wide; with soldered miniature fuse; 500 mA FF

[www.wago.com/280-852](http://www.wago.com/280-852)



**Item no.: 280-852/281-413**  
Fuse plug; 5 mm wide; with soldered miniature fuse; with additional indicator lamp; red LED; DC 15 - 30 V; 500 mA FF

[www.wago.com/280-852/281-413](http://www.wago.com/280-852/281-413)



**Item no.: 280-852/281-414**  
Fuse plug; 5 mm wide; with soldered miniature fuse; with additional indicator lamp; red LED; DC 30 - 65 V; 500 mA FF

[www.wago.com/280-852/281-414](http://www.wago.com/280-852/281-414)



**Item no.: 280-852/281-415**  
Fuse plug; 5 mm wide; with soldered miniature fuse; with additional indicator lamp; red LED; AC 15 - 30 V; 500 mA FF

[www.wago.com/280-852/281-415](http://www.wago.com/280-852/281-415)



**Item no.: 280-854**  
Fuse plug; 5 mm wide; with soldered miniature fuse; 1 A FF

[www.wago.com/280-854](http://www.wago.com/280-854)



**Item no.: 280-854/281-413**  
Fuse plug; 5 mm wide; with soldered miniature fuse; with additional indicator lamp; red LED; DC 15 - 30 V; 1 A FF

[www.wago.com/280-854/281-413](http://www.wago.com/280-854/281-413)

**Item no.: 280-854/281-414**

Fuse plug; 5 mm wide; with soldered miniature fuse; with additional indicator lamp; red LED; DC 30 - 65 V; 1 A FF

[www.wago.com/280-854/281-414](http://www.wago.com/280-854/281-414)**Item no.: 280-854/281-415**

Fuse plug; 5 mm wide; with soldered miniature fuse; with additional indicator lamp; red LED; AC 15 - 30 V; 1 A FF

[www.wago.com/280-854/281-415](http://www.wago.com/280-854/281-415)**Item no.: 280-856**

Fuse plug; 5 mm wide; with soldered miniature fuse; 2 A FF

[www.wago.com/280-856](http://www.wago.com/280-856)**Item no.: 280-856/281-413**

Fuse plug; 5 mm wide; with soldered miniature fuse; with additional indicator lamp; red LED; DC 15 - 30 V; 2 A FF

[www.wago.com/280-856/281-413](http://www.wago.com/280-856/281-413)**Item no.: 280-856/281-414**

Fuse plug; 5 mm wide; with soldered miniature fuse; with additional indicator lamp; red LED; DC 30 - 65 V; 2 A FF

[www.wago.com/280-856/281-414](http://www.wago.com/280-856/281-414)**Item no.: 280-856/281-415**

Fuse plug; 5 mm wide; with soldered miniature fuse; with additional indicator lamp; red LED; AC 15 - 30 V; 2 A FF

[www.wago.com/280-856/281-415](http://www.wago.com/280-856/281-415)**Carrier rail****Item no.: 210-112**

Steel carrier rail; 35 x 7.5 mm; 1 mm thick; 2 m long; slotted; according to EN 60715; "Hole width 25 mm

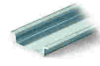
[www.wago.com/210-112](http://www.wago.com/210-112)**Item no.: 210-113**

Steel carrier rail; 35 x 7.5 mm; 1 mm thick; 2 m long; unslotted; according to EN 60715

[www.wago.com/210-113](http://www.wago.com/210-113)**Item no.: 210-114**

Steel carrier rail; 35 x 15 mm; 1.5 mm thick; 2 m long; unslotted; similar to EN 60715

[www.wago.com/210-114](http://www.wago.com/210-114)**Item no.: 210-115**

Steel carrier rail; 35 x 7.5 mm; 1 mm thick; 2 m long; slotted; according to EN 60715; "Hole width 18 mm

[www.wago.com/210-115](http://www.wago.com/210-115)**Item no.: 210-118**

Steel carrier rail; 35 x 15 mm; 2.3 mm thick; 2 m long; unslotted; according to EN 60715

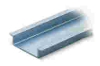
[www.wago.com/210-118](http://www.wago.com/210-118)**Item no.: 210-196**

Aluminum carrier rail; 35 x 8.2 mm; 1.6 mm thick; 2 m long; unslotted; similar to EN 60715

[www.wago.com/210-196](http://www.wago.com/210-196)**Item no.: 210-197**

Steel carrier rail; 35 x 15 mm; 1.5 mm thick; 2 m long; slotted; similar to EN 60715

[www.wago.com/210-197](http://www.wago.com/210-197)**Item no.: 210-198**

Copper carrier rail; 35 x 15 mm; 2.3 mm thick; 2 m long; unslotted; according to EN 60715

[www.wago.com/210-198](http://www.wago.com/210-198)**Item no.: 210-504**

Steel carrier rail; 35 x 7.5 mm; 1 mm thick; 2 m long; slotted; galvanized; according to EN 60715

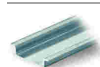
[www.wago.com/210-504](http://www.wago.com/210-504)**Item no.: 210-505**

Steel carrier rail; 35 x 7.5 mm; 1 mm thick; 2 m long; unslotted; galvanized; according to EN 60715

[www.wago.com/210-505](http://www.wago.com/210-505)**Item no.: 210-506**

Steel carrier rail; 35 x 15 mm; 1.5 mm thick; 2 m long; unslotted; galvanized; similar to EN 60715

[www.wago.com/210-506](http://www.wago.com/210-506)



**Item no.: 210-508**  
Steel carrier rail; 35 x 15 mm; 1.5 mm thick; 2 m long; slotted; galvanized; similar to EN 60715

[www.wago.com/210-508](http://www.wago.com/210-508)

tools



**Item no.: 210-657**  
Operating tool with partially insulated shaft; Blade (3.5 x 0.5) mm; short

[www.wago.com/210-657](http://www.wago.com/210-657)



**Item no.: 210-658**  
Operating tool with partially insulated shaft; Blade (3.5 x 0.5) mm; short; angled

[www.wago.com/210-658](http://www.wago.com/210-658)



**Item no.: 210-720**  
Operating tool with partially insulated shaft; Type 2, blade (3.5 x 0.5) mm

[www.wago.com/210-720](http://www.wago.com/210-720)

assembling



**Item no.: 709-154**  
Cover; Type 2; suitable for cover carrier, type 2; 1 m long

[www.wago.com/709-154](http://www.wago.com/709-154)

Insulation stop



**Item no.: 280-470**  
Insulation stop; 0.08 - 0.2 mm<sup>2</sup> "s" (0.14 mm<sup>2</sup> "f-st"); 5 pieces/strip

[www.wago.com/280-470](http://www.wago.com/280-470)



**Item no.: 280-471**  
Insulation stop; 0.25 - 0.5 mm<sup>2</sup>; 5 pieces/strip

[www.wago.com/280-471](http://www.wago.com/280-471)



**Item no.: 280-472**  
Insulation stop; 0.75 - 1 mm<sup>2</sup>; 5 pieces/strip

[www.wago.com/280-472](http://www.wago.com/280-472)

General accessories



**Item no.: 280-801**  
Empty component plug housing; 5 mm wide; 2-pole; Type 1

[www.wago.com/280-801](http://www.wago.com/280-801)



**Item no.: 281-511**  
Fuse plug with pull-tab; for miniature metric fuses 5 x 20 mm and 5 x 25 mm; 6 mm wide

[www.wago.com/281-511](http://www.wago.com/281-511)



**Item no.: 281-512**  
Fuse plug with pull-tab; for miniature metric fuses 5 x 20 mm and 5 x 25 mm; with hole for one led (for self-assembly); 6 mm wide

[www.wago.com/281-512](http://www.wago.com/281-512)



**Item no.: 281-512/281-417**  
Fuse plug with pull-tab; for miniature metric fuses 5 x 20 mm and 5 x 25 mm; with neon lamp, 230 V AC/DC; 6 mm wide

[www.wago.com/281-512/281-417](http://www.wago.com/281-512/281-417)



**Item no.: 281-512/281-418**  
Fuse plug with pull-tab; for miniature metric fuses 5 x 20 mm and 5 x 25 mm; with neon lamp, 120 V AC/DC; 6 mm wide

[www.wago.com/281-512/281-418](http://www.wago.com/281-512/281-418)



**Item no.: 281-512/281-501**  
Fuse plug with pull-tab; for miniature metric fuses 5 x 20 mm and 5 x 25 mm; with LED indicator; 24 V AC/DC; 6 mm wide

[www.wago.com/281-512/281-501](http://www.wago.com/281-512/281-501)











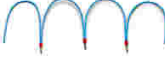







Protective Warning Marker







**Item no.: 280-415**  
Protective warning marker; with high-voltage symbol, black; for 5 terminal blocks

[www.wago.com/280-415](http://www.wago.com/280-415)

**Jumper**

	<b>Item no.: 210-103</b> Wire commoning chain; insulated; 50 connections	<a href="http://www.wago.com/210-103">www.wago.com/210-103</a>
	<b>Item no.: 210-123</b> Wire commoning chain; insulated; 50 connections	<a href="http://www.wago.com/210-123">www.wago.com/210-123</a>
	<b>Item no.: 249-123</b> Push-in type wire jumper; insulated; wire length 180 mm; Conductor cross section 0.75 mm <sup>2</sup>	<a href="http://www.wago.com/249-123">www.wago.com/249-123</a>
	<b>Item no.: 249-125</b> Push-in type wire jumper; insulated; wire length 60 mm; Conductor cross section 0.75 mm <sup>2</sup>	<a href="http://www.wago.com/249-125">www.wago.com/249-125</a>
	<b>Item no.: 249-126</b> Push-in type wire jumper; insulated; wire length 110 mm; Conductor cross section 0.75 mm <sup>2</sup>	<a href="http://www.wago.com/249-126">www.wago.com/249-126</a>
	<b>Item no.: 249-127</b> Push-in type wire jumper; insulated; wire length 250 mm; Conductor cross section 0.75 mm <sup>2</sup>	<a href="http://www.wago.com/249-127">www.wago.com/249-127</a>
	<b>Item no.: 280-402</b> Adjacent jumper; insulated; IN = IN terminal block	<a href="http://www.wago.com/280-402">www.wago.com/280-402</a>
	<b>Item no.: 280-482</b> Comb-style jumper bar; insulated; 2-way; IN = IN terminal block	<a href="http://www.wago.com/280-482">www.wago.com/280-482</a>
	<b>Item no.: 280-483</b> Comb-style jumper bar; insulated; 3-way; IN = IN terminal block	<a href="http://www.wago.com/280-483">www.wago.com/280-483</a>
	<b>Item no.: 280-484</b> Comb-style jumper bar; insulated; 4-way; IN = IN terminal block	<a href="http://www.wago.com/280-484">www.wago.com/280-484</a>
	<b>Item no.: 280-485</b> Comb-style jumper bar; insulated; 5-way; IN = IN terminal block	<a href="http://www.wago.com/280-485">www.wago.com/280-485</a>
	<b>Item no.: 280-490</b> Comb-style jumper bar; insulated; 10-way; IN = IN terminal block	<a href="http://www.wago.com/280-490">www.wago.com/280-490</a>
	<b>Item no.: 280-492</b> Alternate comb-style jumper bar; insulated; 2-way; IN = IN terminal block	<a href="http://www.wago.com/280-492">www.wago.com/280-492</a>
	<b>Item no.: 709-110</b> Wire commoning chain; insulated; 4 connections; 3 x 110 mm	<a href="http://www.wago.com/709-110">www.wago.com/709-110</a>
	<b>Item no.: 709-111</b> Wire commoning chain; insulated; 3 connections; 2 x 120 mm	<a href="http://www.wago.com/709-111">www.wago.com/709-111</a>
	<b>Item no.: 709-112</b> Wire commoning chain; insulated; 3 connections; 2 x 170 mm	<a href="http://www.wago.com/709-112">www.wago.com/709-112</a>
	<b>Item no.: 780-452</b> Staggered jumper; insulated; from 1 to 2; Spacing: 5 mm; suitable for 2-conductor female plugs	<a href="http://www.wago.com/780-452">www.wago.com/780-452</a>
	<b>Item no.: 780-453</b> Staggered jumper; insulated; from 1 to 3; Spacing: 5 mm; suitable for 2-conductor female plugs	<a href="http://www.wago.com/780-453">www.wago.com/780-453</a>
	<b>Item no.: 780-454</b> Staggered jumper; insulated; from 1 to 4; Spacing: 5 mm; suitable for 2-conductor female plugs	<a href="http://www.wago.com/780-454">www.wago.com/780-454</a>













	<b>Item no.: 780-455</b> Staggered jumper; insulated; from 1 to 5; Spacing: 5 mm; suitable for 2-conductor female plugs	<a href="http://www.wago.com/780-455">www.wago.com/780-455</a>
	<b>Item no.: 780-456</b> Staggered jumper; insulated; from 1 to 6; Spacing: 5 mm; suitable for 2-conductor female plugs	<a href="http://www.wago.com/780-456">www.wago.com/780-456</a>
	<b>Item no.: 780-457</b> Staggered jumper; insulated; from 1 to 7; Spacing: 5 mm; suitable for 2-conductor female plugs	<a href="http://www.wago.com/780-457">www.wago.com/780-457</a>
	<b>Item no.: 780-458</b> Staggered jumper; insulated; from 1 to 8; Spacing: 5 mm; suitable for 2-conductor female plugs	<a href="http://www.wago.com/780-458">www.wago.com/780-458</a>

**End plate**

	<b>Item no.: 280-319</b> End and intermediate plate; 1 mm thick; for triple-deck terminal blocks	<a href="http://www.wago.com/280-319">www.wago.com/280-319</a>
--	---	--

**ferrule**

	<b>Item no.: 216-101</b> Ferrule; Sleeve for 0.5 mm <sup>2</sup> / AWG 22; uninsulated; electro-tin plated	<a href="http://www.wago.com/216-101">www.wago.com/216-101</a>
	<b>Item no.: 216-102</b> Ferrule; Sleeve for 0.75 mm <sup>2</sup> / AWG 20; uninsulated; electro-tin plated	<a href="http://www.wago.com/216-102">www.wago.com/216-102</a>
	<b>Item no.: 216-103</b> Ferrule; Sleeve for 1 mm <sup>2</sup> / AWG 18; uninsulated; electro-tin plated	<a href="http://www.wago.com/216-103">www.wago.com/216-103</a>
	<b>Item no.: 216-104</b> Ferrule; Sleeve for 1.5 mm <sup>2</sup> / AWG 16; uninsulated; electro-tin plated	<a href="http://www.wago.com/216-104">www.wago.com/216-104</a>
	<b>Item no.: 216-201</b> Ferrule; Sleeve for 0.5 mm <sup>2</sup> / AWG 22; insulated; electro-tin plated	<a href="http://www.wago.com/216-201">www.wago.com/216-201</a>
	<b>Item no.: 216-202</b> Ferrule; Sleeve for 0.75 mm <sup>2</sup> / AWG 20; insulated; electro-tin plated	<a href="http://www.wago.com/216-202">www.wago.com/216-202</a>
	<b>Item no.: 216-203</b> Ferrule; Sleeve for 1 mm <sup>2</sup> / AWG 18; insulated; electro-tin plated	<a href="http://www.wago.com/216-203">www.wago.com/216-203</a>
	<b>Item no.: 216-204</b> Ferrule; Sleeve for 1.5 mm <sup>2</sup> / AWG 16; insulated; electro-tin plated	<a href="http://www.wago.com/216-204">www.wago.com/216-204</a>
	<b>Item no.: 216-301</b> Ferrule; Sleeve for 0.25 mm <sup>2</sup> / AWG 24; insulated; electro-tin plated	<a href="http://www.wago.com/216-301">www.wago.com/216-301</a>
	<b>Item no.: 216-302</b> Ferrule; Sleeve for 0.34 mm <sup>2</sup> / AWG 24; insulated; electro-tin plated	<a href="http://www.wago.com/216-302">www.wago.com/216-302</a>

**Downloads**

**Documentation**

**Bid Text**

280-565/280-319	Oct 12, 2017	DOC	Download
		25.6 kB	



Subject to changes.

---

WAGO Kontakttechnik GmbH & Co. KG  
Hansastr. 27  
32423 Minden  
Phone: +49571 887-0 | Fax: +49571 887-169  
Email: [info.de@wago.com](mailto:info.de@wago.com) | Web: [www.wago.com](http://www.wago.com)

Do you have any questions about our products?  
We are always happy to take your call at +49 (571) 887-44222.