

Data sheet | Item number: 280-803/281-411  
Diode module; with diode 1N4007; 10 mm wide

[www.wago.com/280-803/281-411](http://www.wago.com/280-803/281-411)

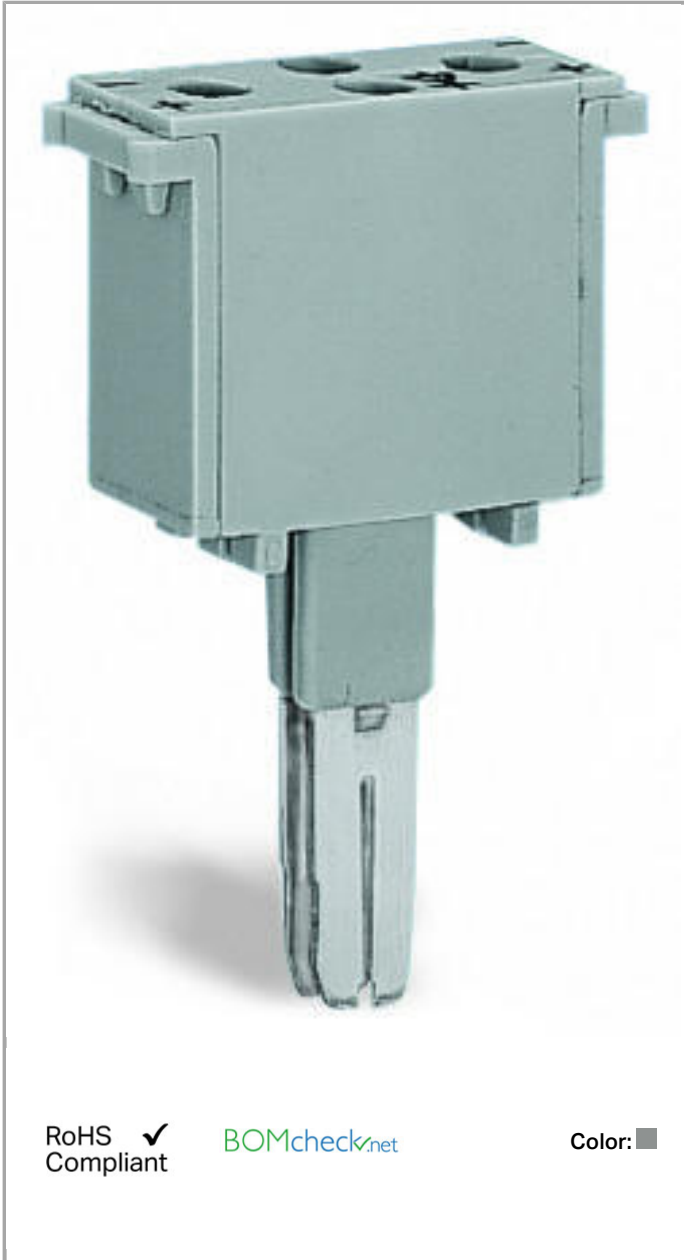

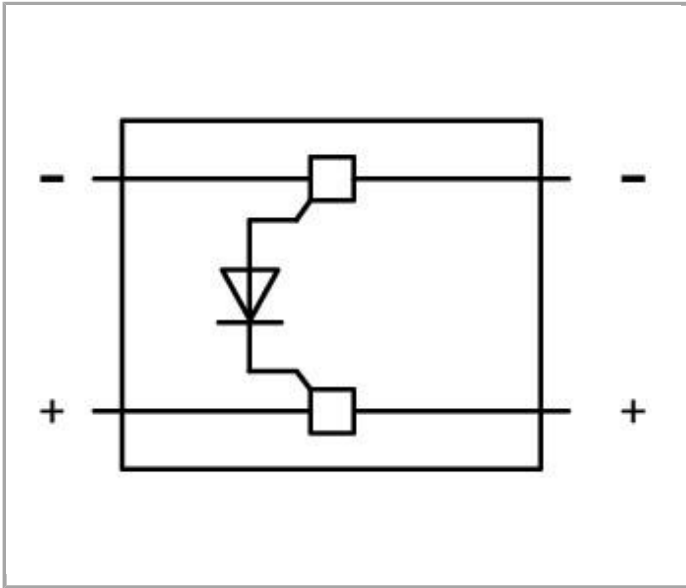

## Data

### Electrical data

Nominal voltage	250 V
Reverse voltage	1000 V

### Ratings per IEC/EN 60664-1

Rated current	0.5 A
---------------	-------

### Geometrical Data

Width	10 mm / 0.394 inch
Plug width	10 mm / 0.394 inch







### Material Data

Color	gray
Insulating material	Polyamide 66 (PA 66)
Fire load	0.087 MJ
Weight	4.2 g

### Commercial data

Country of origin	DE
GTIN	4045454195977
Customs Tariff No.	85369010000
Product Group	1 (Rail Mounted Terminal Blocks)

## Compatible products

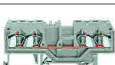
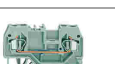
clamps		
	<b>Item no.: 280-101</b> 2-conductor through terminal block; 2.5 mm <sup>2</sup> ; lateral marker slots; for DIN-rail 35 x 15 and 35 x 7.5; CAGE CLAMP®	<a href="http://www.wago.com/280-101">www.wago.com/280-101</a>
	<b>Item no.: 280-601</b> 2-conductor through terminal block; 2.5 mm <sup>2</sup> ; lateral marker slots; for DIN-rail 35 x 15 and 35 x 7.5; CAGE CLAMP®	<a href="http://www.wago.com/280-601">www.wago.com/280-601</a>
	<b>Item no.: 280-603</b> 4-conductor through terminal block; 2.5 mm <sup>2</sup> ; center marking; for DIN-rail 35 x 15 and 35 x 7.5; CAGE CLAMP®	<a href="http://www.wago.com/280-603">www.wago.com/280-603</a>
	<b>Item no.: 280-621</b> 4-conductor through terminal block; 2.5 mm <sup>2</sup> ; lateral marker slots; for DIN-rail 35 x 15 and 35 x 7.5; CAGE CLAMP®	<a href="http://www.wago.com/280-621">www.wago.com/280-621</a>
	<b>Item no.: 280-633</b> 4-conductor through terminal block; 2.5 mm <sup>2</sup> ; center marking; for DIN-rail 35 x 15 and 35 x 7.5; CAGE CLAMP®	<a href="http://www.wago.com/280-633">www.wago.com/280-633</a>
	<b>Item no.: 280-681</b> 3-conductor through terminal block; 2.5 mm <sup>2</sup> ; center marking; for DIN-rail 35 x 15 and 35 x 7.5; CAGE CLAMP®	<a href="http://www.wago.com/280-681">www.wago.com/280-681</a>
	<b>Item no.: 280-833</b> 4-conductor through terminal block; 2.5 mm <sup>2</sup> ; center marking; for DIN-rail 35 x 15 and 35 x 7.5; CAGE CLAMP®	<a href="http://www.wago.com/280-833">www.wago.com/280-833</a>
	<b>Item no.: 280-901</b> 2-conductor through terminal block; 2.5 mm <sup>2</sup> ; center marking; for DIN-rail 35 x 15 and 35 x 7.5; CAGE CLAMP®	<a href="http://www.wago.com/280-901">www.wago.com/280-901</a>

## Downloads

### Documentation

#### Bid Text

280-803/281-411	Oct 12, 2017	DOC 23.6 kB	Download
-----------------	--------------	----------------	----------

### smartDATA

#### CAD data

3D Download 280-803/281-411	URL	Download
-----------------------------	-----	----------



Subject to changes.

---

WAGO Kontakttechnik GmbH & Co. KG

Hansastr. 27

32423 Minden

Phone: +49571 887-0 | Fax: +49571 887-169

Email: [info.de@wago.com](mailto:info.de@wago.com) | Web: [www.wago.com](http://www.wago.com)

Do you have any questions about our products?

We are always happy to take your call at +49 (571) 887-44222.