

Data sheet | Item number: 280-803/281-416
LED module; with red LED; 10 mm wide; AC/DC 48 V

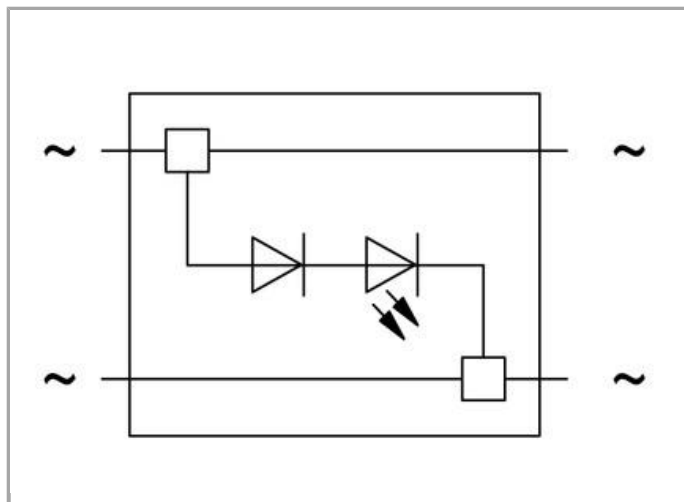

www.wago.com/280-803/281-416



Data

Electrical data

Voltage type (1)

AC/DC

Geometrical Data

Width	10 mm / 0.394 inch
Plug width	10 mm / 0.394 inch

Material Data









Color	gray
Insulating material	Polyamide 66 (PA 66)
Fire load	0.103 MJ
Weight	4.55 g

Commercial data

Country of origin	DE
GTIN	4050821864967
Customs Tariff No.	85369010000
Product Group	1 (Rail Mounted Terminal Blocks)

Compatible products

clamps

	Item no.: 280-101 2-conductor through terminal block; 2.5 mm ² ; lateral marker slots; for DIN-rail 35 x 15 and 35 x 7.5; CAGE CLAMP®	www.wago.com/280-101
	Item no.: 280-601 2-conductor through terminal block; 2.5 mm ² ; lateral marker slots; for DIN-rail 35 x 15 and 35 x 7.5; CAGE CLAMP®	www.wago.com/280-601
	Item no.: 280-603 4-conductor through terminal block; 2.5 mm ² ; center marking; for DIN-rail 35 x 15 and 35 x 7.5; CAGE CLAMP®	www.wago.com/280-603
	Item no.: 280-621 4-conductor through terminal block; 2.5 mm ² ; lateral marker slots; for DIN-rail 35 x 15 and 35 x 7.5; CAGE CLAMP®	www.wago.com/280-621
	Item no.: 280-633 4-conductor through terminal block; 2.5 mm ² ; center marking; for DIN-rail 35 x 15 and 35 x 7.5; CAGE CLAMP®	www.wago.com/280-633
	Item no.: 280-681 3-conductor through terminal block; 2.5 mm ² ; center marking; for DIN-rail 35 x 15 and 35 x 7.5; CAGE CLAMP®	www.wago.com/280-681
	Item no.: 280-833 4-conductor through terminal block; 2.5 mm ² ; center marking; for DIN-rail 35 x 15 and 35 x 7.5; CAGE CLAMP®	www.wago.com/280-833
	Item no.: 280-901 2-conductor through terminal block; 2.5 mm ² ; center marking; for DIN-rail 35 x 15 and 35 x 7.5; CAGE CLAMP®	www.wago.com/280-901



Downloads

Documentation

Bid Text

280-803/281-416	Oct 12, 2017	DOC 24.1 kB	Download
-----------------	--------------	----------------	----------

smartDATA

CAD data

3D Download 280-803/281-416	URL	Download
-----------------------------	-----	----------

Subject to changes.