

**FUSED DISCONNECT TERMINAL  
BLOCK WITH PIVOTABLE FUSE  
HOLDER for miniature fuses 1/4" x 1"  
WITHOUT BLOWN FUSE INDICATION**

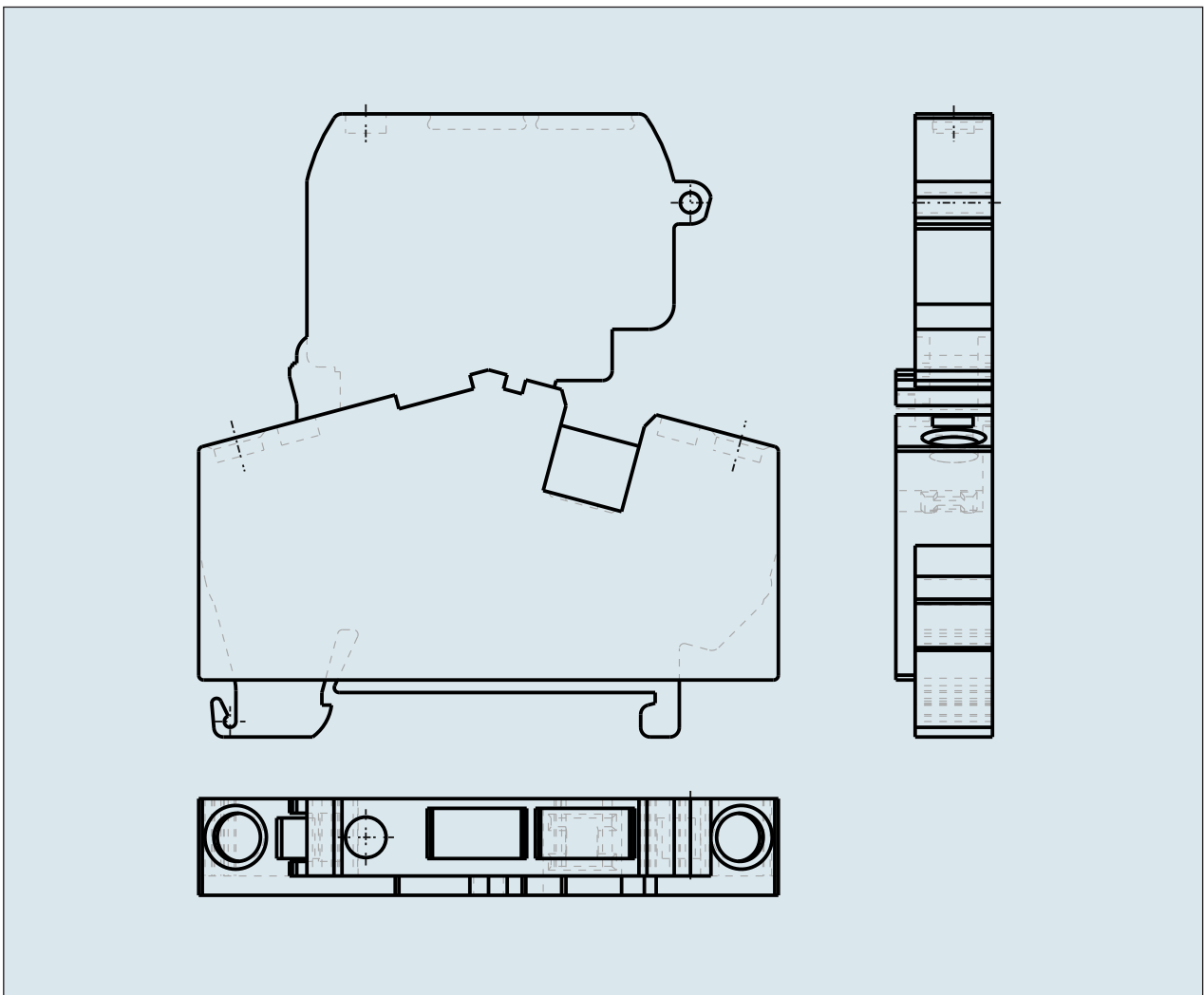
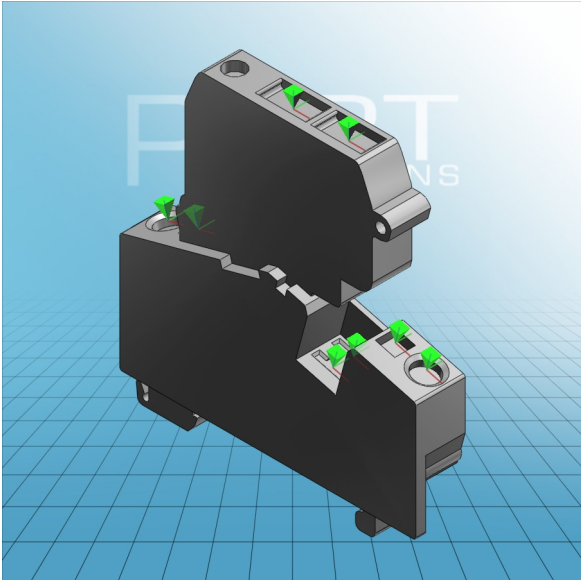

**FUSED DISCONNECT TERMINAL  
BLOCK WITH PIVOTABLE FUSE  
HOLDER for miniature fuses 1/4" x 1"  
WITHOUT BLOWN FUSE INDICATION  
281-613**

<b>ITEM-NO. (ITEM-NO.)</b>	281-613
<b>Cross section1 (Cross section / mm<sup>2</sup>)</b>	0.08 - 4
<b>Cross section2 (Cross section / AWG)</b>	28 - 12
<b>Strip length (Strip length / mm)</b>	9 - 10
<b>Measured voltage (Measured voltage / V)</b>	800
<b>Measured shock voltage (Measured shock voltage / kV)</b>	8
<b>Pollution degree (Pollution degree)</b>	3
<b>Current intensity (Current intensity / A)</b>	10
<b>Height (Height / mm)</b>	60
<b>Width (Width / mm)</b>	10
<b>Depth (Depth / mm)</b>	60
<b>No. of connection Points (No. of connection Points)</b>	2
<b>No. of potentials (No. of potentials)</b>	2
<b>COLOR (COLOR)</b>	grau
<b>WEIGHT (WEIGHT / g)</b>	19.49