

Data sheet | Item number: 281-613/281-417

Fuse disconnect terminal block with pivoting fuse holder; "for miniature metric fuse L¹ x 1¹; 230 V; with blown fuse indication by neon lamp

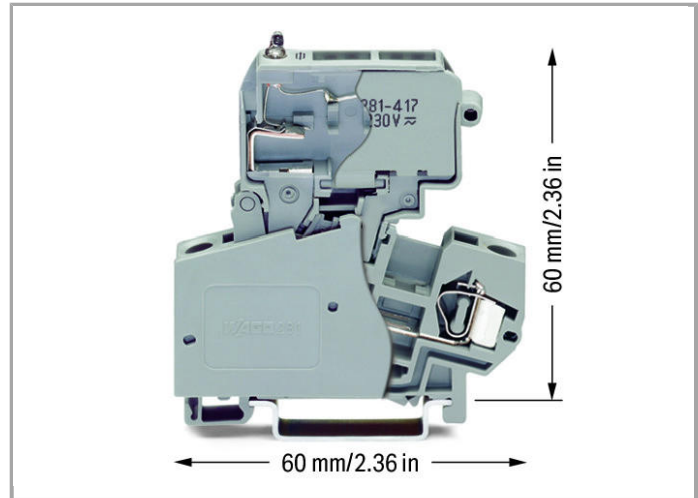

www.wago.com/281-613/281-417

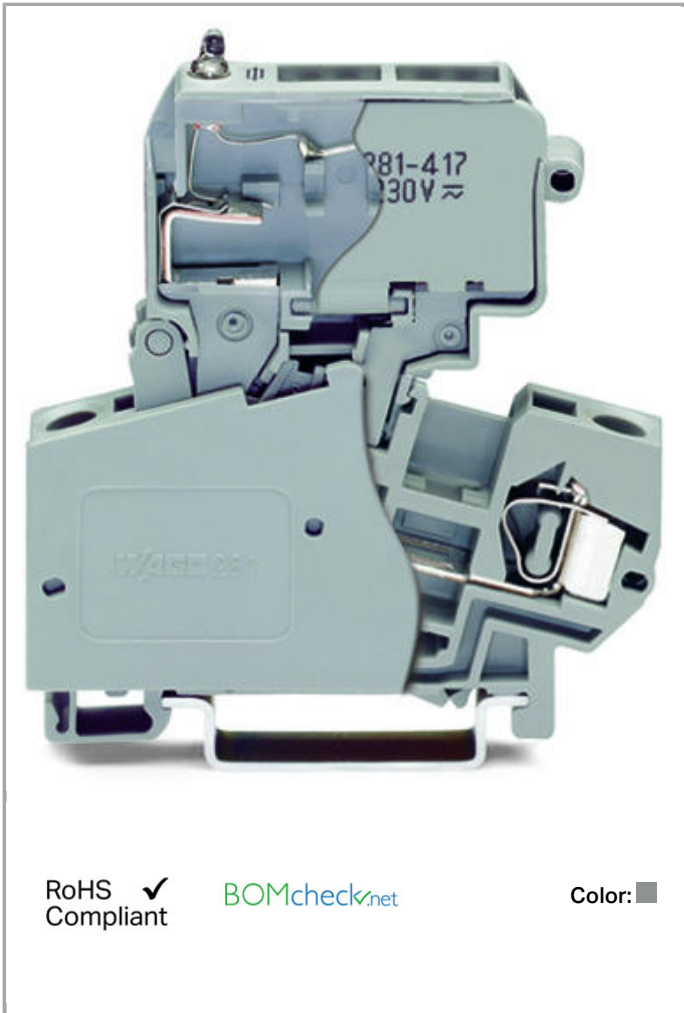

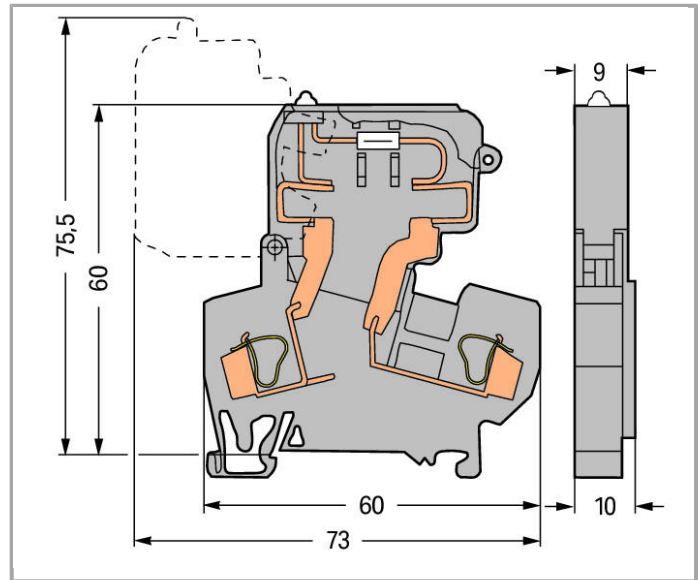
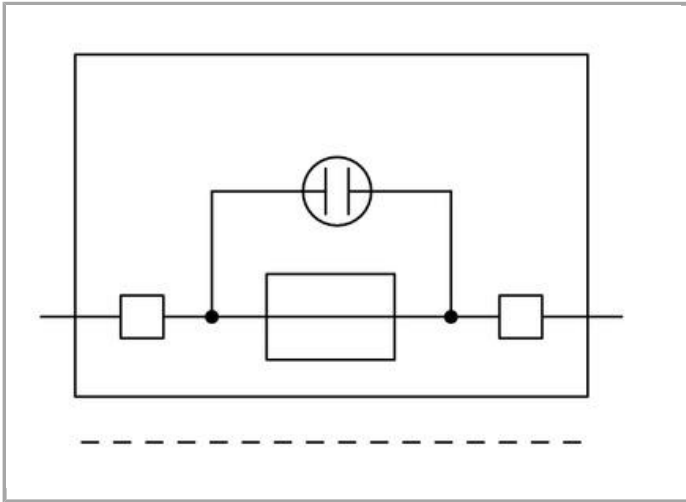

Data

Electrical data

Ratings per IEC/EN 60664-1

| | |
|---------------------------------|---|
| Rated voltage (III / 3) | 800 V |
| Rated impulse voltage (III / 3) | 8 kV |
| Rated current | 10 A |
| Legend (ratings) | (III / 3) ≙ Overvoltage category III / Pollution degree 3 |

Connection data

| | |
|-----------------------------------|--|
| Connection technology | CAGE CLAMP® |
| Actuation type | Operating tool |
| Connectable conductor materials | Copper Aluminum |
| Solid conductor | 0.08 ... 4 mm ² / 28 ... 12 AWG |
| Fine-stranded conductor | 0.08 ... 4 mm ² / 28 ... 12 AWG |
| Strip length | 9 ... 10 mm / 0.35 ... 0.39 Inch |
| Total number of connection points | 2 |
| Total number of potentials | 2 |
| Number of levels | 1 |
| Type of wiring | Front-entry wiring |

Geometrical Data

| | |
|---------------------------------------|--------------------|
| Width | 10 mm / 0.394 inch |
| Height from upper-edge of DIN-35 rail | 60 mm / 2.362 inch |
| Depth | 60 mm / 2.362 inch |

Mechanical data

| | |
|------------------|----------------|
| Design | angled |
| Type of mounting | DIN-35 rail |
| Marking level | Center marking |

Material Data

| | |
|---------------------|----------------------|
| Color | gray |
| Insulating material | Polyamide 66 (PA 66) |
| Fire load | 0.395 MJ |
| Weight | 20.088 g |

Commercial data

| | |
|--------------------|----------------------------------|
| Country of origin | DE |
| GTIN | 4045454197025 |
| Customs Tariff No. | 85369095990 |
| Product Group | 1 (Rail Mounted Terminal Blocks) |

Approvals / Certificates

Country specific Approvals

| Logo | Approval | Certificate name |
|------|---------------------------------|------------------|
| | CSA DEKRA Certification B.V. | 1505034 |

Ship Approvals

| Logo | Approval | Certificate name |
|--|------------------------------------|------------------|
|  | ABS American Bureau of Shipping | 14-HG1293677-PDA |

UL-Approvals

| Logo | Approval | Certificate name |
|--|--------------------------------------|------------------|
|  | UR Underwriters Laboratories Inc. | E45172 |



















Compatible products















Carrier rail















Item no.: 210-112

















Steel carrier rail; 35 x 7.5 mm; 1 mm thick; 2 m long; slotted; according to EN 60715; "Hole width 25

www.wago.com/210-112

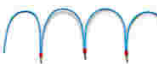
| | | |
|--|--|--|
|  | mm | |
|  | Item no.: 210-113 Steel carrier rail; 35 x 7.5 mm; 1 mm thick; 2 m long; unslotted; according to EN 60715 | www.wago.com/210-113 |
|  | Item no.: 210-114 Steel carrier rail; 35 x 15 mm; 1.5 mm thick; 2 m long; unslotted; similar to EN 60715 | www.wago.com/210-114 |
|  | Item no.: 210-115 Steel carrier rail; 35 x 7.5 mm; 1 mm thick; 2 m long; slotted; according to EN 60715; "Hole width 18 mm | www.wago.com/210-115 |
|  | Item no.: 210-118 Steel carrier rail; 35 x 15 mm; 2.3 mm thick; 2 m long; unslotted; according to EN 60715 | www.wago.com/210-118 |
|  | Item no.: 210-196 Aluminum carrier rail; 35 x 8.2 mm; 1.6 mm thick; 2 m long; unslotted; similar to EN 60715 | www.wago.com/210-196 |
|  | Item no.: 210-197 Steel carrier rail; 35 x 15 mm; 1.5 mm thick; 2 m long; slotted; similar to EN 60715 | www.wago.com/210-197 |
|  | Item no.: 210-198 Copper carrier rail; 35 x 15 mm; 2.3 mm thick; 2 m long; unslotted; according to EN 60715 | www.wago.com/210-198 |
|  | Item no.: 210-504 Steel carrier rail; 35 x 7.5 mm; 1 mm thick; 2 m long; slotted; galvanized; according to EN 60715 | www.wago.com/210-504 |
|  | Item no.: 210-505 Steel carrier rail; 35 x 7.5 mm; 1 mm thick; 2 m long; unslotted; galvanized; according to EN 60715 | www.wago.com/210-505 |
|  | Item no.: 210-506 Steel carrier rail; 35 x 15 mm; 1.5 mm thick; 2 m long; unslotted; galvanized; similar to EN 60715 | www.wago.com/210-506 |
|  | Item no.: 210-508 Steel carrier rail; 35 x 15 mm; 1.5 mm thick; 2 m long; slotted; galvanized; similar to EN 60715 | www.wago.com/210-508 |
| ferrule | | |
|  | Item no.: 216-106 Ferrule; Sleeve for 2.5 mm ² / AWG 14; uninsulated; electro-tin plated | www.wago.com/216-106 |
|  | Item no.: 216-201 Ferrule; Sleeve for 0.5 mm ² / AWG 22; insulated; electro-tin plated | www.wago.com/216-201 |
|  | Item no.: 216-202 Ferrule; Sleeve for 0.75 mm ² / AWG 20; insulated; electro-tin plated | www.wago.com/216-202 |
|  | Item no.: 216-203 Ferrule; Sleeve for 1 mm ² / AWG 18; insulated; electro-tin plated | www.wago.com/216-203 |
|  | Item no.: 216-204 Ferrule; Sleeve for 1.5 mm ² / AWG 16; insulated; electro-tin plated | www.wago.com/216-204 |
|  | Item no.: 216-205 Ferrule; Sleeve for 2.08 mm ² / AWG 14; insulated; electro-tin plated | www.wago.com/216-205 |
|  | Item no.: 216-206 Ferrule; Sleeve for 2.5 mm ² / AWG 14; insulated; electro-tin plated | www.wago.com/216-206 |

| | | |
|--|--|--|
|  | Item no.: 216-241 Ferrule; Sleeve for 0.5 mm ² / AWG 22; insulated; electro-tin plated; electrolytic copper; gastight crimped; acc. to DIN 46228, Part 4/09.90 | www.wago.com/216-241 |
|  | Item no.: 216-242 Ferrule; Sleeve for 0.75 mm ² / AWG 20; insulated; electro-tin plated; electrolytic copper; gastight crimped; acc. to DIN 46228, Part 4/09.90 | www.wago.com/216-242 |
|  | Item no.: 216-243 Ferrule; Sleeve for 1 mm ² / AWG 18; insulated; electro-tin plated; electrolytic copper; gastight crimped; acc. to DIN 46228, Part 4/09.90 | www.wago.com/216-243 |
|  | Item no.: 216-244 Ferrule; Sleeve for 1.5 mm ² / AWG 16; insulated; electro-tin plated; electrolytic copper; gastight crimped; acc. to DIN 46228, Part 4/09.90 | www.wago.com/216-244 |
|  | Item no.: 216-246 Ferrule; Sleeve for 2.5 mm ² / AWG 14; insulated; electro-tin plated; electrolytic copper; gastight crimped; acc. to DIN 46228, Part 4/09.90 | www.wago.com/216-246 |
|  | Item no.: 216-301 Ferrule; Sleeve for 0.25 mm ² / AWG 24; insulated; electro-tin plated | www.wago.com/216-301 |
|  | Item no.: 216-302 Ferrule; Sleeve for 0.34 mm ² / AWG 24; insulated; electro-tin plated | www.wago.com/216-302 |
| check | | |
|  | Item no.: 210-137 Test plug; 2.3 mm Ø; with 500 mm cable | www.wago.com/210-137 |
| tools | | |
|  | Item no.: 210-657 Operating tool with partially insulated shaft; Blade (3.5 x 0.5) mm; short | www.wago.com/210-657 |
|  | Item no.: 210-658 Operating tool with partially insulated shaft; Blade (3.5 x 0.5) mm; short; angled | www.wago.com/210-658 |
|  | Item no.: 210-720 Operating tool with partially insulated shaft; Type 2, blade (3.5 x 0.5) mm | www.wago.com/210-720 |
| End plate | | |
|  | Item no.: 281-309 End and intermediate plate; 2.5 mm thick | www.wago.com/281-309 |
|  | Item no.: 281-311 End and intermediate plate; 2.5 mm thick | www.wago.com/281-311 |
| Marking accessories | | |
|  | Item no.: 2009-115 WMB-Inline; for smartPRINTER; on reel; stretchable 5 - 5.2 mm; plain; snap-on type | www.wago.com/2009-115 |
|  | Item no.: 2009-115/000-002 WMB-Inline; for smartPRINTER; on reel; stretchable 5 - 5.2 mm; plain; snap-on type | www.wago.com/2009-115/000-002 |

| | | |
|--|---|--|
|  | Item no.: 2009-115/000-006 WMB-Inline; for smartPRINTER; on reel; stretchable 5 - 5.2 mm; plain; snap-on type | www.wago.com/2009-115/000-006 |
|  | Item no.: 2009-115/000-007 WMB-Inline; for smartPRINTER; on reel; stretchable 5 - 5.2 mm; plain; snap-on type | www.wago.com/2009-115/000-007 |
|  | Item no.: 2009-115/000-012 WMB-Inline; for smartPRINTER; on reel; stretchable 5 - 5.2 mm; plain; snap-on type | www.wago.com/2009-115/000-012 |
|  | Item no.: 2009-115/000-017 WMB-Inline; for smartPRINTER; on reel; stretchable 5 - 5.2 mm; plain; snap-on type | www.wago.com/2009-115/000-017 |
|  | Item no.: 2009-115/000-023 WMB-Inline; for smartPRINTER; on reel; stretchable 5 - 5.2 mm; plain; snap-on type | www.wago.com/2009-115/000-023 |
|  | Item no.: 2009-115/000-024 WMB-Inline; for smartPRINTER; on reel; stretchable 5 - 5.2 mm; plain; snap-on type | www.wago.com/2009-115/000-024 |
|  | Item no.: 793-501 WMB marking card; as card; not stretchable; plain; snap-on type | www.wago.com/793-501 |
|  | Item no.: 793-501/000-002 WMB marking card; as card; not stretchable; plain; snap-on type | www.wago.com/793-501/000-002 |
|  | Item no.: 793-501/000-005 WMB marking card; as card; not stretchable; plain; snap-on type | www.wago.com/793-501/000-005 |
|  | Item no.: 793-501/000-006 WMB marking card; as card; not stretchable; plain; snap-on type | www.wago.com/793-501/000-006 |
|  | Item no.: 793-501/000-007 WMB marking card; as card; not stretchable; plain; snap-on type | www.wago.com/793-501/000-007 |
|  | Item no.: 793-501/000-012 WMB marking card; as card; not stretchable; plain; snap-on type | www.wago.com/793-501/000-012 |
|  | Item no.: 793-501/000-017 WMB marking card; as card; not stretchable; plain; snap-on type | www.wago.com/793-501/000-017 |
|  | Item no.: 793-501/000-023 WMB marking card; as card; not stretchable; plain; snap-on type | www.wago.com/793-501/000-023 |
|  | Item no.: 793-501/000-024 WMB marking card; as card; not stretchable; plain; snap-on type | www.wago.com/793-501/000-024 |

| | | |
|--|---|--|
|  | Item no.: 793-5501 WMB marking card; as card; for terminal block width 5 - 17.5 mm; stretchable 5 - 5.2 mm; plain; snap-on type | www.wago.com/793-5501 |
|  | Item no.: 793-5501/000-002 WMB marking card; as card; for terminal block width 5 - 17.5 mm; stretchable 5 - 5.2 mm; plain; snap-on type | www.wago.com/793-5501/000-002 |
|  | Item no.: 793-5501/000-005 WMB marking card; as card; stretchable 5 - 5.2 mm; plain; snap-on type | www.wago.com/793-5501/000-005 |
|  | Item no.: 793-5501/000-006 WMB marking card; as card; stretchable 5 - 5.2 mm; plain; snap-on type | www.wago.com/793-5501/000-006 |
|  | Item no.: 793-5501/000-007 WMB marking card; as card; stretchable 5 - 5.2 mm; plain; snap-on type | www.wago.com/793-5501/000-007 |
|  | Item no.: 793-5501/000-012 WMB marking card; as card; stretchable 5 - 5.2 mm; plain; snap-on type | www.wago.com/793-5501/000-012 |
|  | Item no.: 793-5501/000-017 WMB marking card; as card; stretchable 5 - 5.2 mm; plain; snap-on type | www.wago.com/793-5501/000-017 |
|  | Item no.: 793-5501/000-023 WMB marking card; as card; stretchable 5 - 5.2 mm; plain; snap-on type | www.wago.com/793-5501/000-023 |
|  | Item no.: 793-5501/000-024 WMB marking card; as card; stretchable 5 - 5.2 mm; plain; snap-on type | www.wago.com/793-5501/000-024 |
| Jumper | | |
|  | Item no.: 210-103 Wire commoning chain; insulated; 50 connections | www.wago.com/210-103 |
|  | Item no.: 210-123 Wire commoning chain; insulated; 50 connections | www.wago.com/210-123 |
|  | Item no.: 249-123 Push-in type wire jumper; insulated; wire length 180 mm; Conductor cross section 0.75 mm ² | www.wago.com/249-123 |
|  | Item no.: 249-125 Push-in type wire jumper; insulated; wire length 60 mm; Conductor cross section 0.75 mm ² | www.wago.com/249-125 |
|  | Item no.: 249-126 Push-in type wire jumper; insulated; wire length 110 mm; Conductor cross section 0.75 mm ² | www.wago.com/249-126 |
|  | Item no.: 249-127 Push-in type wire jumper; insulated; wire length 250 mm; Conductor cross section 0.75 mm ² | www.wago.com/249-127 |
|  | Item no.: 281-402 Adjacent jumper; insulated; IN = IN terminal block | www.wago.com/281-402 |



Item no.: 709-110
Wire commoning chain; insulated; 4 connections; 3 x 110 mm

www.wago.com/709-110



Item no.: 709-111
Wire commoning chain; insulated; 3 connections; 2 x 120 mm

www.wago.com/709-111



Item no.: 709-112
Wire commoning chain; insulated; 3 connections; 2 x 170 mm

www.wago.com/709-112

General accessories



Item no.: 249-120
Group marker carrier

www.wago.com/249-120



Item no.: 280-404
Test plug adapter; 5 mm wide; for test plug 210-137 (2.3 mm Ø); suitable for 1.5 mm² - 4 mm² tbs

www.wago.com/280-404



Item no.: 281-407
Test plug; 6 mm wide; Nominal current 24 A; for 0.08 mm² - 2.5 mm²

www.wago.com/281-407

N-busbar



Item no.: 210-254
Interlocking link; mechanically locks multiple links; 1 m long

www.wago.com/210-254

assembling



Item no.: 209-106
Mounting carrier; for isolated mounting on DIN 35 rails

www.wago.com/209-106



Item no.: 709-153
Cover; Type 1; suitable for cover carrier, type 1; 1 m long

www.wago.com/709-153

Downloads

Documentation

Bid Text

| | | | |
|-----------------|--------------|----------------|----------|
| 281-613/281-417 | Oct 12, 2017 | DOC 26.6 kB | Download |
|-----------------|--------------|----------------|----------|

smartDATA

CAD data

| | | |
|-----------------------------|-----|----------|
| 3D Download 281-613/281-417 | URL | Download |
|-----------------------------|-----|----------|



Subject to changes.

WAGO Kontakttechnik GmbH & Co. KG

Hansastr. 27

32423 Minden

Phone: +49571 887-0 | Fax: +49571 887-169

Email: info.de@wago.com | Web: www.wago.com

Do you have any questions about our products?

We are always happy to take your call at +49 (571) 887-44222.