

Data sheet | Item number: 281-613/281-542

Fuse disconnect terminal block with pivoting fuse holder; "for miniature metric fuse L<sup>1</sup> x 1<sup>1</sup>"; 30 - 65 V; with blown fuse indication by LED

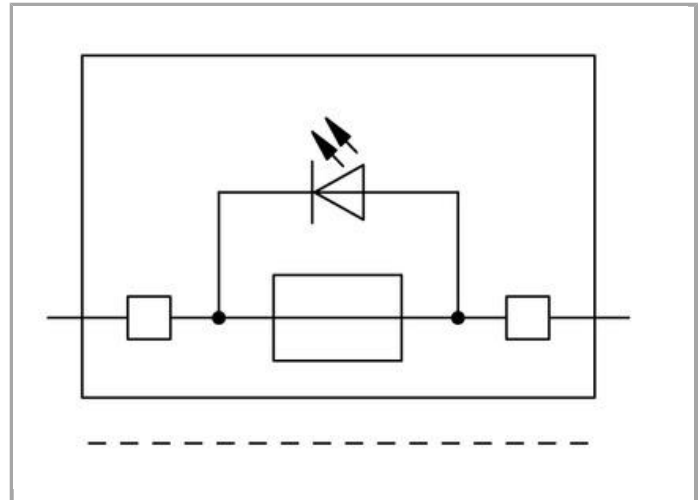

[www.wago.com/281-613/281-542](http://www.wago.com/281-613/281-542)



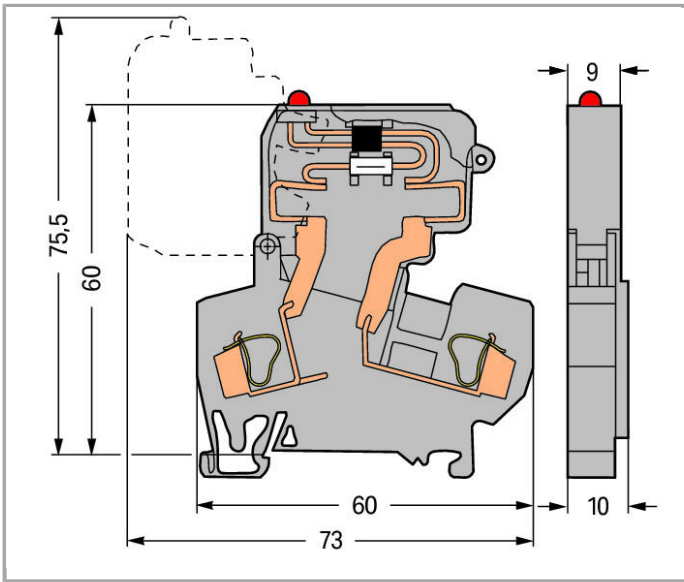

## Data

### Electrical data

#### Ratings per IEC/EN 60664-1

Rated voltage (III / 3)	800 V
Rated impulse voltage (III / 3)	8 kV
Rated current	10 A
Legend (ratings)	(III / 3) $\hat{=}$ Overvoltage category III / Pollution degree 3

### Connection data

Connection technology	CAGE CLAMP®
Actuation type	Operating tool
Connectable conductor materials	Copper Aluminum
Solid conductor	0.08 ... 4 mm <sup>2</sup> / 28 ... 12 AWG
Fine-stranded conductor	0.08 ... 4 mm <sup>2</sup> / 28 ... 12 AWG
Strip length	9 ... 10 mm / 0.35 ... 0.39 Inch
Total number of connection points	2
Total number of potentials	2
Number of levels	1
Type of wiring	Front-entry wiring

### Geometrical Data

Width	10 mm / 0.394 inch
Height from upper-edge of DIN-35 rail	60 mm / 2.362 inch
Depth	60 mm / 2.362 inch

## Mechanical data

Design	angled
Type of mounting	DIN-35 rail
Marking level	Center marking

## Material Data









Color	gray
Insulating material	Polyamide 66 (PA 66)
Fire load	0.4 MJ
Weight	20.1 g

















## Commercial data

Country of origin	DE
GTIN	4045454319458
Customs Tariff No.	85369095990
Product Group	1 (Rail Mounted Terminal Blocks)

## Compatible products

### Carrier rail

	<b>Item no.: 210-112</b> Steel carrier rail; 35 x 7.5 mm; 1 mm thick; 2 m long; slotted; according to EN 60715; "Hole width 25 mm	<a href="http://www.wago.com/210-112">www.wago.com/210-112</a>
	<b>Item no.: 210-113</b> Steel carrier rail; 35 x 7.5 mm; 1 mm thick; 2 m long; unslotted; according to EN 60715	<a href="http://www.wago.com/210-113">www.wago.com/210-113</a>
	<b>Item no.: 210-114</b> Steel carrier rail; 35 x 15 mm; 1.5 mm thick; 2 m long; unslotted; similar to EN 60715	<a href="http://www.wago.com/210-114">www.wago.com/210-114</a>
	<b>Item no.: 210-115</b> Steel carrier rail; 35 x 7.5 mm; 1 mm thick; 2 m long; slotted; according to EN 60715; "Hole width 18 mm	<a href="http://www.wago.com/210-115">www.wago.com/210-115</a>
	<b>Item no.: 210-118</b> Steel carrier rail; 35 x 15 mm; 2.3 mm thick; 2 m long; unslotted; according to EN 60715	<a href="http://www.wago.com/210-118">www.wago.com/210-118</a>
	<b>Item no.: 210-196</b> Aluminum carrier rail; 35 x 8.2 mm; 1.6 mm thick; 2 m long; unslotted; similar to EN 60715	<a href="http://www.wago.com/210-196">www.wago.com/210-196</a>
	<b>Item no.: 210-197</b> Steel carrier rail; 35 x 15 mm; 1.5 mm thick; 2 m long; slotted; similar to EN 60715	<a href="http://www.wago.com/210-197">www.wago.com/210-197</a>
	<b>Item no.: 210-198</b> Copper carrier rail; 35 x 15 mm; 2.3 mm thick; 2 m long; unslotted; according to EN 60715	<a href="http://www.wago.com/210-198">www.wago.com/210-198</a>
	<b>Item no.: 210-504</b> Steel carrier rail; 35 x 7.5 mm; 1 mm thick; 2 m long; slotted; galvanized; according to EN 60715	<a href="http://www.wago.com/210-504">www.wago.com/210-504</a>
	<b>Item no.: 210-505</b>	

	Steel carrier rail; 35 x 7.5 mm; 1 mm thick; 2 m long; unslotted; galvanized; according to EN 60715	<a href="http://www.wago.com/210-505">www.wago.com/210-505</a>
	<b>Item no.: 210-506</b> Steel carrier rail; 35 x 15 mm; 1.5 mm thick; 2 m long; unslotted; galvanized; similar to EN 60715	<a href="http://www.wago.com/210-506">www.wago.com/210-506</a>
	<b>Item no.: 210-508</b> Steel carrier rail; 35 x 15 mm; 1.5 mm thick; 2 m long; slotted; galvanized; similar to EN 60715	<a href="http://www.wago.com/210-508">www.wago.com/210-508</a>
<b>assembling</b>		
	<b>Item no.: 209-106</b> Mounting carrier; for isolated mounting on DIN 35 rails	<a href="http://www.wago.com/209-106">www.wago.com/209-106</a>
	<b>Item no.: 709-153</b> Cover; Type 1; suitable for cover carrier, type 1; 1 m long	<a href="http://www.wago.com/709-153">www.wago.com/709-153</a>
<b>tools</b>		
	<b>Item no.: 210-657</b> Operating tool with partially insulated shaft; Blade (3.5 x 0.5) mm; short	<a href="http://www.wago.com/210-657">www.wago.com/210-657</a>
	<b>Item no.: 210-658</b> Operating tool with partially insulated shaft; Blade (3.5 x 0.5) mm; short; angled	<a href="http://www.wago.com/210-658">www.wago.com/210-658</a>
	<b>Item no.: 210-720</b> Operating tool with partially insulated shaft; Type 2, blade (3.5 x 0.5) mm	<a href="http://www.wago.com/210-720">www.wago.com/210-720</a>
<b>check</b>		
	<b>Item no.: 210-137</b> Test plug; 2.3 mm Ø; with 500 mm cable	<a href="http://www.wago.com/210-137">www.wago.com/210-137</a>
<b>Jumper</b>		
	<b>Item no.: 210-103</b> Wire commoning chain; insulated; 50 connections	<a href="http://www.wago.com/210-103">www.wago.com/210-103</a>
	<b>Item no.: 210-123</b> Wire commoning chain; insulated; 50 connections	<a href="http://www.wago.com/210-123">www.wago.com/210-123</a>
	<b>Item no.: 249-123</b> Push-in type wire jumper; insulated; wire length 180 mm; Conductor cross section 0.75 mm <sup>2</sup>	<a href="http://www.wago.com/249-123">www.wago.com/249-123</a>
	<b>Item no.: 249-125</b> Push-in type wire jumper; insulated; wire length 60 mm; Conductor cross section 0.75 mm <sup>2</sup>	<a href="http://www.wago.com/249-125">www.wago.com/249-125</a>
	<b>Item no.: 249-126</b> Push-in type wire jumper; insulated; wire length 110 mm; Conductor cross section 0.75 mm <sup>2</sup>	<a href="http://www.wago.com/249-126">www.wago.com/249-126</a>
	<b>Item no.: 249-127</b> Push-in type wire jumper; insulated; wire length 250 mm; Conductor cross section 0.75 mm <sup>2</sup>	<a href="http://www.wago.com/249-127">www.wago.com/249-127</a>
	<b>Item no.: 281-402</b> Adjacent jumper; insulated; IN = IN terminal block	<a href="http://www.wago.com/281-402">www.wago.com/281-402</a>
	<b>Item no.: 709-110</b> Wire commoning chain; insulated; 4 connections; 3 x 110 mm	<a href="http://www.wago.com/709-110">www.wago.com/709-110</a>



**Item no.: 709-111**  
Wire commoning chain; insulated; 3 connections; 2 x 120 mm

[www.wago.com/709-111](http://www.wago.com/709-111)



**Item no.: 709-112**  
Wire commoning chain; insulated; 3 connections; 2 x 170 mm

[www.wago.com/709-112](http://www.wago.com/709-112)

#### ferrule



**Item no.: 216-106**  
Ferrule; Sleeve for 2.5 mm<sup>2</sup> / AWG 14; uninsulated; electro-tin plated

[www.wago.com/216-106](http://www.wago.com/216-106)



**Item no.: 216-201**  
Ferrule; Sleeve for 0.5 mm<sup>2</sup> / AWG 22; insulated; electro-tin plated

[www.wago.com/216-201](http://www.wago.com/216-201)



**Item no.: 216-202**  
Ferrule; Sleeve for 0.75 mm<sup>2</sup> / AWG 20; insulated; electro-tin plated

[www.wago.com/216-202](http://www.wago.com/216-202)



**Item no.: 216-203**  
Ferrule; Sleeve for 1 mm<sup>2</sup> / AWG 18; insulated; electro-tin plated

[www.wago.com/216-203](http://www.wago.com/216-203)



**Item no.: 216-204**  
Ferrule; Sleeve for 1.5 mm<sup>2</sup> / AWG 16; insulated; electro-tin plated

[www.wago.com/216-204](http://www.wago.com/216-204)



**Item no.: 216-205**  
Ferrule; Sleeve for 2.08 mm<sup>2</sup> / AWG 14; insulated; electro-tin plated

[www.wago.com/216-205](http://www.wago.com/216-205)



**Item no.: 216-206**  
Ferrule; Sleeve for 2.5 mm<sup>2</sup> / AWG 14; insulated; electro-tin plated

[www.wago.com/216-206](http://www.wago.com/216-206)



**Item no.: 216-241**  
Ferrule; Sleeve for 0.5 mm<sup>2</sup> / AWG 22; insulated; electro-tin plated; electrolytic copper; gastight crimped; acc. to DIN 46228, Part 4/09.90

[www.wago.com/216-241](http://www.wago.com/216-241)



**Item no.: 216-242**  
Ferrule; Sleeve for 0.75 mm<sup>2</sup> / AWG 20; insulated; electro-tin plated; electrolytic copper; gastight crimped; acc. to DIN 46228, Part 4/09.90

[www.wago.com/216-242](http://www.wago.com/216-242)



**Item no.: 216-243**  
Ferrule; Sleeve for 1 mm<sup>2</sup> / AWG 18; insulated; electro-tin plated; electrolytic copper; gastight crimped; acc. to DIN 46228, Part 4/09.90

[www.wago.com/216-243](http://www.wago.com/216-243)



**Item no.: 216-244**  
Ferrule; Sleeve for 1.5 mm<sup>2</sup> / AWG 16; insulated; electro-tin plated; electrolytic copper; gastight crimped; acc. to DIN 46228, Part 4/09.90

[www.wago.com/216-244](http://www.wago.com/216-244)



**Item no.: 216-246**  
Ferrule; Sleeve for 2.5 mm<sup>2</sup> / AWG 14; insulated; electro-tin plated; electrolytic copper; gastight crimped; acc. to DIN 46228, Part 4/09.90

[www.wago.com/216-246](http://www.wago.com/216-246)



**Item no.: 216-301**  
Ferrule; Sleeve for 0.25 mm<sup>2</sup> / AWG 24; insulated; electro-tin plated

[www.wago.com/216-301](http://www.wago.com/216-301)



**Item no.: 216-302**  
Ferrule; Sleeve for 0.34 mm<sup>2</sup> / AWG 24; insulated; electro-tin plated

[www.wago.com/216-302](http://www.wago.com/216-302)

#### General accessories



**Item no.: 249-120**  
Group marker carrier

[www.wago.com/249-120](http://www.wago.com/249-120)

**Item no.: 280-404**Test plug adapter; 5 mm wide; for test plug 210-137 (2.3 mm Ø); suitable for 1.5 mm<sup>2</sup> - 4 mm<sup>2</sup> tbs[www.wago.com/280-404](http://www.wago.com/280-404)**Item no.: 281-407**Test plug; 6 mm wide; Nominal current 24 A; for 0.08 mm<sup>2</sup> - 2.5 mm<sup>2</sup>[www.wago.com/281-407](http://www.wago.com/281-407)**Marking accessories****Item no.: 2009-115**

WMB-Inline; for smartPRINTER; on reel; stretchable 5 - 5.2 mm; plain; snap-on type

[www.wago.com/2009-115](http://www.wago.com/2009-115)**Item no.: 2009-115/000-002**

WMB-Inline; for smartPRINTER; on reel; stretchable 5 - 5.2 mm; plain; snap-on type

[www.wago.com/2009-115/000-002](http://www.wago.com/2009-115/000-002)**Item no.: 2009-115/000-006**

WMB-Inline; for smartPRINTER; on reel; stretchable 5 - 5.2 mm; plain; snap-on type

[www.wago.com/2009-115/000-006](http://www.wago.com/2009-115/000-006)**Item no.: 2009-115/000-007**

WMB-Inline; for smartPRINTER; on reel; stretchable 5 - 5.2 mm; plain; snap-on type

[www.wago.com/2009-115/000-007](http://www.wago.com/2009-115/000-007)**Item no.: 2009-115/000-012**

WMB-Inline; for smartPRINTER; on reel; stretchable 5 - 5.2 mm; plain; snap-on type

[www.wago.com/2009-115/000-012](http://www.wago.com/2009-115/000-012)**Item no.: 2009-115/000-017**

WMB-Inline; for smartPRINTER; on reel; stretchable 5 - 5.2 mm; plain; snap-on type

[www.wago.com/2009-115/000-017](http://www.wago.com/2009-115/000-017)**Item no.: 2009-115/000-023**

WMB-Inline; for smartPRINTER; on reel; stretchable 5 - 5.2 mm; plain; snap-on type

[www.wago.com/2009-115/000-023](http://www.wago.com/2009-115/000-023)**Item no.: 2009-115/000-024**

WMB-Inline; for smartPRINTER; on reel; stretchable 5 - 5.2 mm; plain; snap-on type

[www.wago.com/2009-115/000-024](http://www.wago.com/2009-115/000-024)**Item no.: 793-501**

WMB marking card; as card; not stretchable; plain; snap-on type

[www.wago.com/793-501](http://www.wago.com/793-501)**Item no.: 793-501/000-002**

WMB marking card; as card; not stretchable; plain; snap-on type

[www.wago.com/793-501/000-002](http://www.wago.com/793-501/000-002)**Item no.: 793-501/000-005**

WMB marking card; as card; not stretchable; plain; snap-on type

[www.wago.com/793-501/000-005](http://www.wago.com/793-501/000-005)**Item no.: 793-501/000-006**

WMB marking card; as card; not stretchable; plain; snap-on type

[www.wago.com/793-501/000-006](http://www.wago.com/793-501/000-006)**Item no.: 793-501/000-007**

WMB marking card; as card; not stretchable; plain; snap-on type

[www.wago.com/793-501/000-007](http://www.wago.com/793-501/000-007)



**Item no.: 793-501/000-012**  
WMB marking card; as card; not stretchable; plain; snap-on type

[www.wago.com/793-501/000-012](http://www.wago.com/793-501/000-012)



**Item no.: 793-501/000-017**  
WMB marking card; as card; not stretchable; plain; snap-on type

[www.wago.com/793-501/000-017](http://www.wago.com/793-501/000-017)



**Item no.: 793-501/000-023**  
WMB marking card; as card; not stretchable; plain; snap-on type

[www.wago.com/793-501/000-023](http://www.wago.com/793-501/000-023)



**Item no.: 793-501/000-024**  
WMB marking card; as card; not stretchable; plain; snap-on type

[www.wago.com/793-501/000-024](http://www.wago.com/793-501/000-024)



**Item no.: 793-5501**  
WMB marking card; as card; for terminal block width 5 - 17.5 mm; stretchable 5 - 5.2 mm; plain; snap-on type

[www.wago.com/793-5501](http://www.wago.com/793-5501)



**Item no.: 793-5501/000-002**  
WMB marking card; as card; for terminal block width 5 - 17.5 mm; stretchable 5 - 5.2 mm; plain; snap-on type

[www.wago.com/793-5501/000-002](http://www.wago.com/793-5501/000-002)



**Item no.: 793-5501/000-005**  
WMB marking card; as card; stretchable 5 - 5.2 mm; plain; snap-on type

[www.wago.com/793-5501/000-005](http://www.wago.com/793-5501/000-005)



**Item no.: 793-5501/000-006**  
WMB marking card; as card; stretchable 5 - 5.2 mm; plain; snap-on type

[www.wago.com/793-5501/000-006](http://www.wago.com/793-5501/000-006)



**Item no.: 793-5501/000-007**  
WMB marking card; as card; stretchable 5 - 5.2 mm; plain; snap-on type

[www.wago.com/793-5501/000-007](http://www.wago.com/793-5501/000-007)



**Item no.: 793-5501/000-012**  
WMB marking card; as card; stretchable 5 - 5.2 mm; plain; snap-on type

[www.wago.com/793-5501/000-012](http://www.wago.com/793-5501/000-012)



**Item no.: 793-5501/000-017**  
WMB marking card; as card; stretchable 5 - 5.2 mm; plain; snap-on type

[www.wago.com/793-5501/000-017](http://www.wago.com/793-5501/000-017)



**Item no.: 793-5501/000-023**  
WMB marking card; as card; stretchable 5 - 5.2 mm; plain; snap-on type

[www.wago.com/793-5501/000-023](http://www.wago.com/793-5501/000-023)



**Item no.: 793-5501/000-024**  
WMB marking card; as card; stretchable 5 - 5.2 mm; plain; snap-on type

[www.wago.com/793-5501/000-024](http://www.wago.com/793-5501/000-024)

#### End plate



**Item no.: 281-309**  
End and intermediate plate; 2.5 mm thick

[www.wago.com/281-309](http://www.wago.com/281-309)



**Item no.: 281-311**  
End and intermediate plate; 2.5 mm thick

[www.wago.com/281-311](http://www.wago.com/281-311)

N-busbar



Item no.: 210-254

Interlocking link; mechanically locks multiple links; 1 m long

[www.wago.com/210-254](http://www.wago.com/210-254)

Downloads

Documentation

Bid Text

281-613/281-542	Oct 12, 2017	DOC 26.1 kB	Download
-----------------	--------------	----------------	----------

smartDATA

CAD data

3D Download 281-613/281-542	URL	Download
-----------------------------	-----	----------

Subject to changes.