

Data sheet | Item number: 281-683

3-conductor disconnect terminal block; for DIN-rail 35 x 15 and 35 x 7.5; 4 mm<sup>2</sup>; CAGE CLAMP®

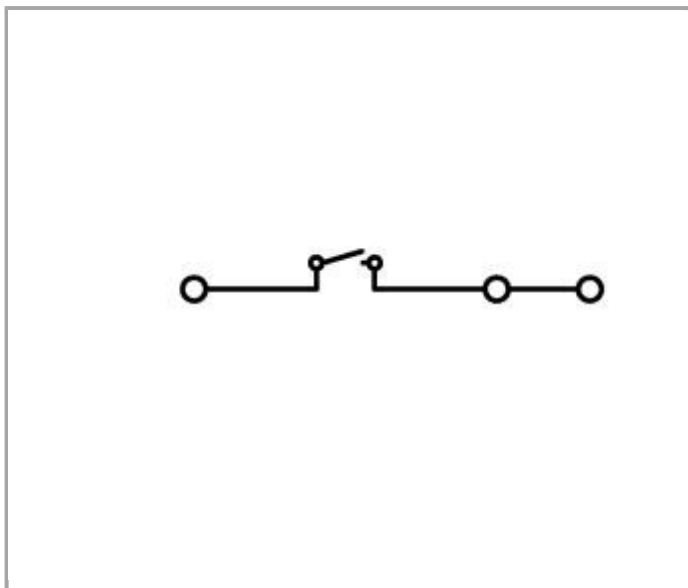

[www.wago.com/281-683](http://www.wago.com/281-683)

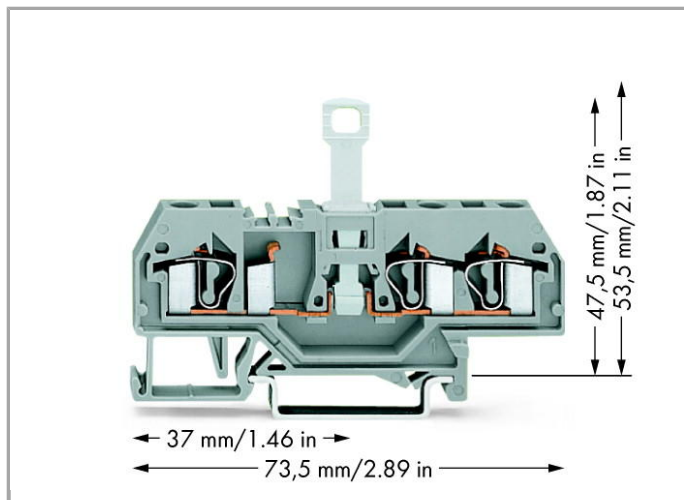
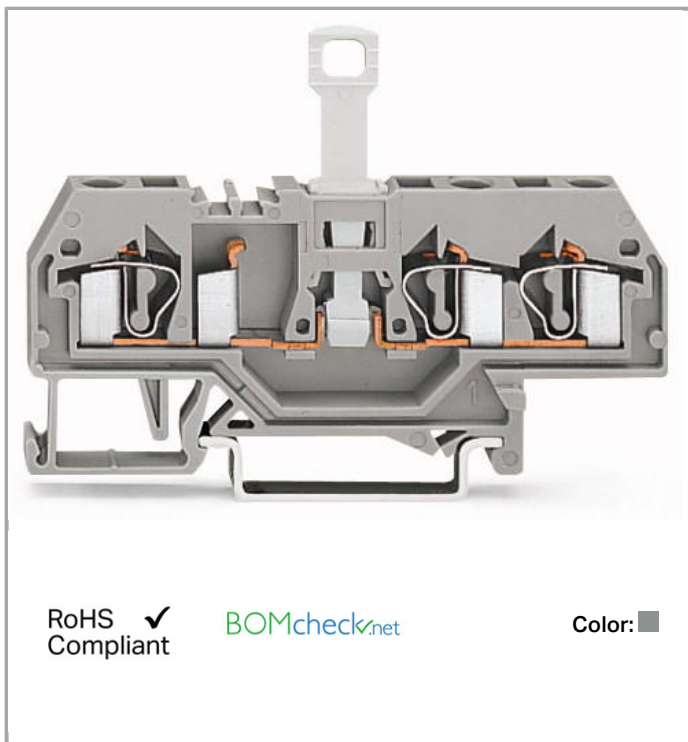

Data  
Electrical data

### Ratings per IEC/EN 60664-1

Rated voltage (III / 3)	400 V
Rated impulse voltage (III / 3)	6 kV
Rated current	10 A
Legend (ratings)	(III / 3) $\triangleq$ Overvoltage category III / Pollution degree 3

### Connection data

Connection technology	CAGE CLAMP®
Actuation type	Operating tool
Connectable conductor materials	Copper Aluminum
Solid conductor	0.08 ... 4 mm <sup>2</sup> / 28 ... 12 AWG
Fine-stranded conductor	0.08 ... 4 mm <sup>2</sup> / 28 ... 12 AWG
Strip length	9 ... 10 mm / 0.35 ... 0.39 Inch
Total number of connection points	3
Total number of potentials	2
Number of levels	1
Type of wiring	Front-entry wiring

### Geometrical Data

Width	6 mm / 0.236 inch
Height from upper-edge of DIN-35 rail	53.5 mm / 2.106 inch
Depth	73.5 mm / 2.894 inch

### Mechanical data

Design	horizontal
Type of mounting	DIN-35 rail
Marking level	Center marking

### Material Data

Color	gray
Insulating material	Polyamide 66 (PA 66)
Fire load	0.191 MJ
Weight	11.515 g

### Commercial data

Country of origin	DE
GTIN	4044918632027

Customs Tariff No.



85365080990

Product Group



1 (Rail Mounted Terminal Blocks)

## Approvals / Certificates

### Country specific Approvals



Logo	Approval	Certificate name
	CCA DEKRA Certification B.V.	NTR NL-7454/A1
	CCA DEKRA Certification B.V.	NTR NL-7454/A1
	CSA DEKRA Certification B.V.	1505034
	CSA DEKRA Certification B.V.	1505034

### Ship Approvals



















Logo	Approval	Certificate name
	ABS American Bureau of Shipping	14-HG1293677-PDA
	BV Bureau Veritas S.A.	07436/E0 BV
	LR Lloyds Register	91/20112 (E9)

## Compatible products











### Insulation stop

	Item no.: 281-470 Insulation stop; 0.08 - 0.2 mm <sup>2</sup> "s" (0.14 mm <sup>2</sup> "f-st"); 5 pieces/strip	<a href="http://www.wago.com/281-470">www.wago.com/281-470</a>
	Item no.: 281-471 Insulation stop; 0.25 - 0.5 mm <sup>2</sup> ; 5 pieces/strip	<a href="http://www.wago.com/281-471">www.wago.com/281-471</a>
	Item no.: 281-472 Insulation stop; 0.75 - 1.5 mm <sup>2</sup> ; 5 pieces/strip	<a href="http://www.wago.com/281-472">www.wago.com/281-472</a>



### Carrier rail

	<b>Item no.: 210-112</b> Steel carrier rail; 35 x 7.5 mm; 1 mm thick; 2 m long; slotted; according to EN 60715; "Hole width 25 mm	<a href="http://www.wago.com/210-112">www.wago.com/210-112</a>
	<b>Item no.: 210-113</b> Steel carrier rail; 35 x 7.5 mm; 1 mm thick; 2 m long; unslotted; according to EN 60715	<a href="http://www.wago.com/210-113">www.wago.com/210-113</a>
	<b>Item no.: 210-114</b> Steel carrier rail; 35 x 15 mm; 1.5 mm thick; 2 m long; unslotted; similar to EN 60715	<a href="http://www.wago.com/210-114">www.wago.com/210-114</a>
	<b>Item no.: 210-115</b> Steel carrier rail; 35 x 7.5 mm; 1 mm thick; 2 m long; slotted; according to EN 60715; "Hole width 18 mm	<a href="http://www.wago.com/210-115">www.wago.com/210-115</a>
	<b>Item no.: 210-118</b> Steel carrier rail; 35 x 15 mm; 2.3 mm thick; 2 m long; unslotted; according to EN 60715	<a href="http://www.wago.com/210-118">www.wago.com/210-118</a>
	<b>Item no.: 210-196</b> Aluminum carrier rail; 35 x 8.2 mm; 1.6 mm thick; 2 m long; unslotted; similar to EN 60715	<a href="http://www.wago.com/210-196">www.wago.com/210-196</a>
	<b>Item no.: 210-197</b> Steel carrier rail; 35 x 15 mm; 1.5 mm thick; 2 m long; slotted; similar to EN 60715	<a href="http://www.wago.com/210-197">www.wago.com/210-197</a>
	<b>Item no.: 210-198</b> Copper carrier rail; 35 x 15 mm; 2.3 mm thick; 2 m long; unslotted; according to EN 60715	<a href="http://www.wago.com/210-198">www.wago.com/210-198</a>
	<b>Item no.: 210-504</b> Steel carrier rail; 35 x 7.5 mm; 1 mm thick; 2 m long; slotted; galvanized; according to EN 60715	<a href="http://www.wago.com/210-504">www.wago.com/210-504</a>
	<b>Item no.: 210-505</b> Steel carrier rail; 35 x 7.5 mm; 1 mm thick; 2 m long; unslotted; galvanized; according to EN 60715	<a href="http://www.wago.com/210-505">www.wago.com/210-505</a>
	<b>Item no.: 210-506</b> Steel carrier rail; 35 x 15 mm; 1.5 mm thick; 2 m long; unslotted; galvanized; similar to EN 60715	<a href="http://www.wago.com/210-506">www.wago.com/210-506</a>
	<b>Item no.: 210-508</b> Steel carrier rail; 35 x 15 mm; 1.5 mm thick; 2 m long; slotted; galvanized; similar to EN 60715	<a href="http://www.wago.com/210-508">www.wago.com/210-508</a>
<b>check</b>		
	<b>Item no.: 210-136</b> Test plug; 2 mm Ø; with 500 mm cable	<a href="http://www.wago.com/210-136">www.wago.com/210-136</a>
	<b>Item no.: 210-137</b> Test plug; 2.3 mm Ø; with 500 mm cable	<a href="http://www.wago.com/210-137">www.wago.com/210-137</a>
<b>End plate</b>		
	<b>Item no.: 281-324</b> End and intermediate plate; 2.5 mm thick	<a href="http://www.wago.com/281-324">www.wago.com/281-324</a>
	<b>Item no.: 281-326</b> End and intermediate plate; 2.5 mm thick	<a href="http://www.wago.com/281-326">www.wago.com/281-326</a>
	<b>Item no.: 281-344</b> Separator plate; 2 mm thick; oversized	<a href="http://www.wago.com/281-344">www.wago.com/281-344</a>
	<b>Item no.: 281-346</b> Separator plate; 2 mm thick; oversized	<a href="http://www.wago.com/281-346">www.wago.com/281-346</a>

## Jumper

	<b>Item no.: 210-103</b> Wire commoning chain; insulated; 50 connections	<a href="http://www.wago.com/210-103">www.wago.com/210-103</a>
	<b>Item no.: 210-123</b> Wire commoning chain; insulated; 50 connections	<a href="http://www.wago.com/210-123">www.wago.com/210-123</a>
	<b>Item no.: 281-482</b> Comb-style jumper bar; insulated; 2-way; IN = IN terminal block	<a href="http://www.wago.com/281-482">www.wago.com/281-482</a>
	<b>Item no.: 281-483</b> Comb-style jumper bar; insulated; 3-way; IN = IN terminal block	<a href="http://www.wago.com/281-483">www.wago.com/281-483</a>
	<b>Item no.: 281-485</b> Comb-style jumper bar; insulated; 5-way; IN = IN terminal block	<a href="http://www.wago.com/281-485">www.wago.com/281-485</a>
	<b>Item no.: 281-490</b> Comb-style jumper bar; insulated; 10-way; IN = IN terminal block	<a href="http://www.wago.com/281-490">www.wago.com/281-490</a>
	<b>Item no.: 281-492</b> Alternate comb-style jumper bar; insulated; 2-way; IN = IN terminal block	<a href="http://www.wago.com/281-492">www.wago.com/281-492</a>
	<b>Item no.: 709-110</b> Wire commoning chain; insulated; 4 connections; 3 x 110 mm	<a href="http://www.wago.com/709-110">www.wago.com/709-110</a>
	<b>Item no.: 709-111</b> Wire commoning chain; insulated; 3 connections; 2 x 120 mm	<a href="http://www.wago.com/709-111">www.wago.com/709-111</a>
	<b>Item no.: 709-112</b> Wire commoning chain; insulated; 3 connections; 2 x 170 mm	<a href="http://www.wago.com/709-112">www.wago.com/709-112</a>
	<b>Item no.: 781-455</b> Staggered jumper; insulated; from 1 to 5; Spacing: 6 mm	<a href="http://www.wago.com/781-455">www.wago.com/781-455</a>



## tools

	<b>Item no.: 210-657</b> Operating tool with partially insulated shaft; Blade (3.5 x 0.5) mm; short	<a href="http://www.wago.com/210-657">www.wago.com/210-657</a>
	<b>Item no.: 210-658</b> Operating tool with partially insulated shaft; Blade (3.5 x 0.5) mm; short; angled	<a href="http://www.wago.com/210-658">www.wago.com/210-658</a>
	<b>Item no.: 210-720</b> Operating tool with partially insulated shaft; Type 2, blade (3.5 x 0.5) mm	<a href="http://www.wago.com/210-720">www.wago.com/210-720</a>















## Protective Warning Marker

	<b>Item no.: 281-415</b> Protective warning marker; with high-voltage symbol, black; for 5 terminal blocks	<a href="http://www.wago.com/281-415">www.wago.com/281-415</a>
------------------------------------------------------------------------------------	---------------------------------------------------------------------------------------------------------------	----------------------------------------------------------------



## assembling















	<b>Item no.: 209-106</b> Mounting carrier; for isolated mounting on DIN 35 rails	<a href="http://www.wago.com/209-106">www.wago.com/209-106</a>
	<b>Item no.: 709-153</b> Cover; Type 1; suitable for cover carrier, type 1; 1 m long	<a href="http://www.wago.com/709-153">www.wago.com/709-153</a>

## ferrule

	<b>Item no.: 216-106</b> Ferrule; Sleeve for 2.5 mm <sup>2</sup> / AWG 14; uninsulated; electro-tin plated	<a href="http://www.wago.com/216-106">www.wago.com/216-106</a>
	<b>Item no.: 216-201</b> Ferrule; Sleeve for 0.5 mm <sup>2</sup> / AWG 22; insulated; electro-tin plated	<a href="http://www.wago.com/216-201">www.wago.com/216-201</a>
	<b>Item no.: 216-202</b> Ferrule; Sleeve for 0.75 mm <sup>2</sup> / AWG 20; insulated; electro-tin plated	<a href="http://www.wago.com/216-202">www.wago.com/216-202</a>
	<b>Item no.: 216-203</b> Ferrule; Sleeve for 1 mm <sup>2</sup> / AWG 18; insulated; electro-tin plated	<a href="http://www.wago.com/216-203">www.wago.com/216-203</a>
	<b>Item no.: 216-204</b> Ferrule; Sleeve for 1.5 mm <sup>2</sup> / AWG 16; insulated; electro-tin plated	<a href="http://www.wago.com/216-204">www.wago.com/216-204</a>
	<b>Item no.: 216-205</b> Ferrule; Sleeve for 2.08 mm <sup>2</sup> / AWG 14; insulated; electro-tin plated	<a href="http://www.wago.com/216-205">www.wago.com/216-205</a>
	<b>Item no.: 216-206</b> Ferrule; Sleeve for 2.5 mm <sup>2</sup> / AWG 14; insulated; electro-tin plated	<a href="http://www.wago.com/216-206">www.wago.com/216-206</a>
	<b>Item no.: 216-241</b> Ferrule; Sleeve for 0.5 mm <sup>2</sup> / AWG 22; insulated; electro-tin plated; electrolytic copper; gastight crimped; acc. to DIN 46228, Part 4/09.90	<a href="http://www.wago.com/216-241">www.wago.com/216-241</a>
	<b>Item no.: 216-242</b> Ferrule; Sleeve for 0.75 mm <sup>2</sup> / AWG 20; insulated; electro-tin plated; electrolytic copper; gastight crimped; acc. to DIN 46228, Part 4/09.90	<a href="http://www.wago.com/216-242">www.wago.com/216-242</a>
	<b>Item no.: 216-243</b> Ferrule; Sleeve for 1 mm <sup>2</sup> / AWG 18; insulated; electro-tin plated; electrolytic copper; gastight crimped; acc. to DIN 46228, Part 4/09.90	<a href="http://www.wago.com/216-243">www.wago.com/216-243</a>
	<b>Item no.: 216-244</b> Ferrule; Sleeve for 1.5 mm <sup>2</sup> / AWG 16; insulated; electro-tin plated; electrolytic copper; gastight crimped; acc. to DIN 46228, Part 4/09.90	<a href="http://www.wago.com/216-244">www.wago.com/216-244</a>
	<b>Item no.: 216-246</b> Ferrule; Sleeve for 2.5 mm <sup>2</sup> / AWG 14; insulated; electro-tin plated; electrolytic copper; gastight crimped; acc. to DIN 46228, Part 4/09.90	<a href="http://www.wago.com/216-246">www.wago.com/216-246</a>
	<b>Item no.: 216-301</b> Ferrule; Sleeve for 0.25 mm <sup>2</sup> / AWG 24; insulated; electro-tin plated	<a href="http://www.wago.com/216-301">www.wago.com/216-301</a>
	<b>Item no.: 216-302</b> Ferrule; Sleeve for 0.34 mm <sup>2</sup> / AWG 24; insulated; electro-tin plated	<a href="http://www.wago.com/216-302">www.wago.com/216-302</a>

## Marking accessories

	<b>Item no.: 2009-115</b> WMB-Inline; for smartPRINTER; on reel; stretchable 5 - 5.2 mm; plain; snap-on type	<a href="http://www.wago.com/2009-115">www.wago.com/2009-115</a>
	<b>Item no.: 2009-115/000-002</b> WMB-Inline; for smartPRINTER; on reel; stretchable 5 - 5.2 mm; plain; snap-on type	<a href="http://www.wago.com/2009-115/000-002">www.wago.com/2009-115/000-002</a>
	<b>Item no.: 2009-115/000-006</b> WMB-Inline; for smartPRINTER; on reel; stretchable 5 - 5.2 mm; plain; snap-on type	<a href="http://www.wago.com/2009-115/000-006">www.wago.com/2009-115/000-006</a>

	<b>Item no.: 2009-115/000-007</b> WMB-Inline; for smartPRINTER; on reel; stretchable 5 - 5.2 mm; plain; snap-on type	<a href="http://www.wago.com/2009-115/000-007">www.wago.com/2009-115/000-007</a>
	<b>Item no.: 2009-115/000-012</b> WMB-Inline; for smartPRINTER; on reel; stretchable 5 - 5.2 mm; plain; snap-on type	<a href="http://www.wago.com/2009-115/000-012">www.wago.com/2009-115/000-012</a>
	<b>Item no.: 2009-115/000-017</b> WMB-Inline; for smartPRINTER; on reel; stretchable 5 - 5.2 mm; plain; snap-on type	<a href="http://www.wago.com/2009-115/000-017">www.wago.com/2009-115/000-017</a>
	<b>Item no.: 2009-115/000-023</b> WMB-Inline; for smartPRINTER; on reel; stretchable 5 - 5.2 mm; plain; snap-on type	<a href="http://www.wago.com/2009-115/000-023">www.wago.com/2009-115/000-023</a>
	<b>Item no.: 2009-115/000-024</b> WMB-Inline; for smartPRINTER; on reel; stretchable 5 - 5.2 mm; plain; snap-on type	<a href="http://www.wago.com/2009-115/000-024">www.wago.com/2009-115/000-024</a>
	<b>Item no.: 793-501</b> WMB marking card; as card; not stretchable; plain; snap-on type	<a href="http://www.wago.com/793-501">www.wago.com/793-501</a>
	<b>Item no.: 793-501/000-002</b> WMB marking card; as card; not stretchable; plain; snap-on type	<a href="http://www.wago.com/793-501/000-002">www.wago.com/793-501/000-002</a>
	<b>Item no.: 793-501/000-005</b> WMB marking card; as card; not stretchable; plain; snap-on type	<a href="http://www.wago.com/793-501/000-005">www.wago.com/793-501/000-005</a>
	<b>Item no.: 793-501/000-006</b> WMB marking card; as card; not stretchable; plain; snap-on type	<a href="http://www.wago.com/793-501/000-006">www.wago.com/793-501/000-006</a>
	<b>Item no.: 793-501/000-007</b> WMB marking card; as card; not stretchable; plain; snap-on type	<a href="http://www.wago.com/793-501/000-007">www.wago.com/793-501/000-007</a>
	<b>Item no.: 793-501/000-012</b> WMB marking card; as card; not stretchable; plain; snap-on type	<a href="http://www.wago.com/793-501/000-012">www.wago.com/793-501/000-012</a>
	<b>Item no.: 793-501/000-017</b> WMB marking card; as card; not stretchable; plain; snap-on type	<a href="http://www.wago.com/793-501/000-017">www.wago.com/793-501/000-017</a>
	<b>Item no.: 793-501/000-023</b> WMB marking card; as card; not stretchable; plain; snap-on type	<a href="http://www.wago.com/793-501/000-023">www.wago.com/793-501/000-023</a>
	<b>Item no.: 793-501/000-024</b> WMB marking card; as card; not stretchable; plain; snap-on type	<a href="http://www.wago.com/793-501/000-024">www.wago.com/793-501/000-024</a>
	<b>Item no.: 793-5501</b> WMB marking card; as card; for terminal block width 5 - 17.5 mm; stretchable 5 - 5.2 mm; plain; snap-on type	<a href="http://www.wago.com/793-5501">www.wago.com/793-5501</a>

**Item no.: 793-5501/000-002**

WMB marking card; as card; for terminal block width 5 - 17.5 mm; stretchable 5 - 5.2 mm; plain; snap-on type

[www.wago.com/793-5501/000-002](http://www.wago.com/793-5501/000-002)**Item no.: 793-5501/000-005**

WMB marking card; as card; stretchable 5 - 5.2 mm; plain; snap-on type

[www.wago.com/793-5501/000-005](http://www.wago.com/793-5501/000-005)**Item no.: 793-5501/000-006**

WMB marking card; as card; stretchable 5 - 5.2 mm; plain; snap-on type

[www.wago.com/793-5501/000-006](http://www.wago.com/793-5501/000-006)**Item no.: 793-5501/000-007**

WMB marking card; as card; stretchable 5 - 5.2 mm; plain; snap-on type

[www.wago.com/793-5501/000-007](http://www.wago.com/793-5501/000-007)**Item no.: 793-5501/000-012**

WMB marking card; as card; stretchable 5 - 5.2 mm; plain; snap-on type

[www.wago.com/793-5501/000-012](http://www.wago.com/793-5501/000-012)**Item no.: 793-5501/000-017**

WMB marking card; as card; stretchable 5 - 5.2 mm; plain; snap-on type

[www.wago.com/793-5501/000-017](http://www.wago.com/793-5501/000-017)**Item no.: 793-5501/000-023**

WMB marking card; as card; stretchable 5 - 5.2 mm; plain; snap-on type

[www.wago.com/793-5501/000-023](http://www.wago.com/793-5501/000-023)**Item no.: 793-5501/000-024**

WMB marking card; as card; stretchable 5 - 5.2 mm; plain; snap-on type

[www.wago.com/793-5501/000-024](http://www.wago.com/793-5501/000-024)**General accessories****Item no.: 209-107**

Test socket; insulated; 2 mm Ø

[www.wago.com/209-107](http://www.wago.com/209-107)**Item no.: 209-108**

Test socket; insulated; 2.3 mm Ø

[www.wago.com/209-108](http://www.wago.com/209-108)**Item no.: 249-105**

Group marker carrier

[www.wago.com/249-105](http://www.wago.com/249-105)**Item no.: 709-170**

Disconnect lock; for disconnect tab used on 280/281 and 769 Series disconnect terminal blocks

[www.wago.com/709-170](http://www.wago.com/709-170)**Downloads****Documentation****Bid Text**

281-683

Oct 12, 2017

DOC  
24.6 kB

Download





smartDATA

CAD data

3D Download 281-683

URL

Download

---

Subject to changes.