

Data sheet | Item number: 281-912

2-conductor disconnect terminal block; for DIN-rail 35 x 15 and 35 x 7.5; 4 mm²; CAGE CLAMP®

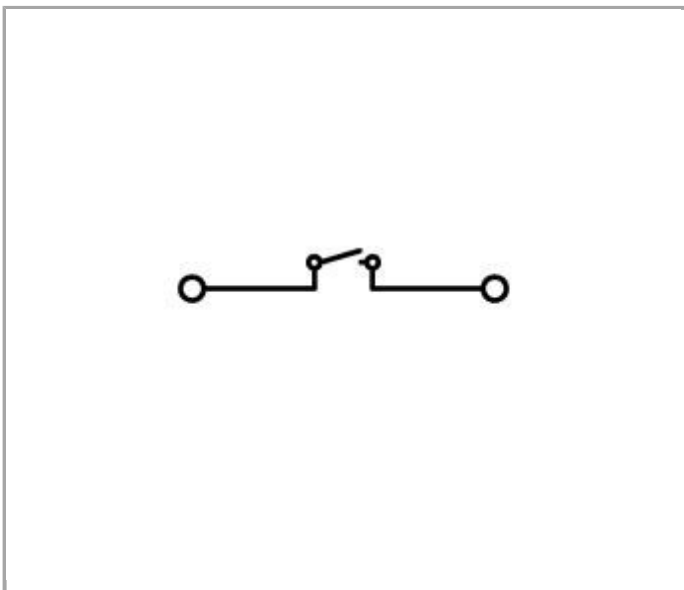

www.wago.com/281-912

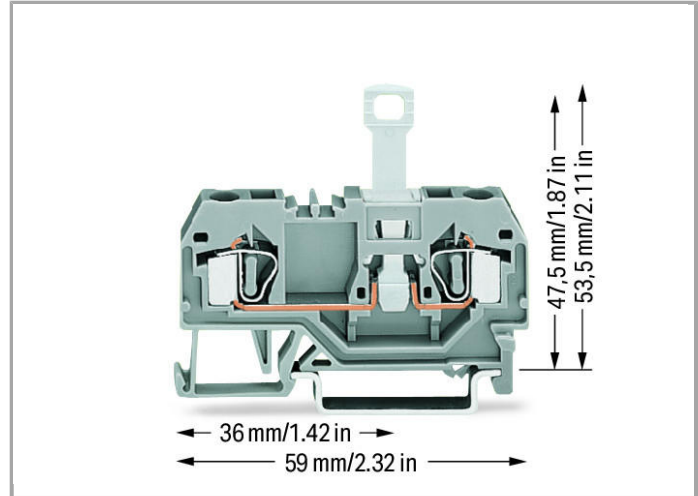
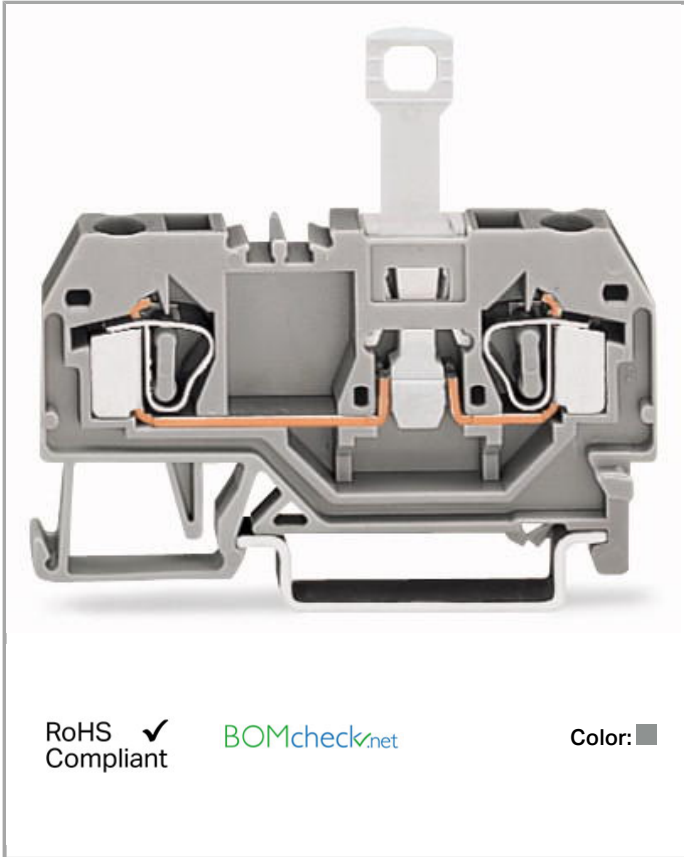

Data



Electrical data

Ratings per IEC/EN 60664-1

Rated voltage (III / 3)	400 V
Rated impulse voltage (III / 3)	6 kV
Rated current	10 A
Legend (ratings)	(III / 3) $\hat{=}$ Overvoltage category III / Pollution degree 3

Connection data

Connection technology	CAGE CLAMP®
Actuation type	Operating tool
Connectable conductor materials	Copper Aluminum
Solid conductor	0.08 ... 4 mm ² / 28 ... 12 AWG
Fine-stranded conductor	0.08 ... 4 mm ² / 28 ... 12 AWG
Strip length	9 ... 10 mm / 0.35 ... 0.39 Inch
Total number of connection points	2
Total number of potentials	2
Number of levels	1
Type of wiring	Front-entry wiring

Geometrical Data

Width	6 mm / 0.236 inch
Height from upper-edge of DIN-35 rail	53.5 mm / 2.106 inch
Depth	59 mm / 2.323 inch

Mechanical data

Design	horizontal
Type of mounting	DIN-35 rail
Marking level	Center marking

Material Data

Color	gray
Insulating material	Polyamide 66 (PA 66)
Fire load	0.158 MJ
Weight	8.473 g



Commercial data

Country of origin	DE
-------------------	----



GTIN	4044918631778
Customs Tariff No.	85365080990
Product Group	1 (Rail Mounted Terminal Blocks)

Approvals / Certificates

Country specific Approvals



Logo	Approval	Certificate name
	CCA DEKRA Certification B.V.	NTR NL-7454/A1
	CCA DEKRA Certification B.V.	NTR NL-7454/A1
	CSA DEKRA Certification B.V.	1505034
	CSA DEKRA Certification B.V.	1505034















Ship Approvals

Logo	Approval	Certificate name
	ABS American Bureau of Shipping	14-HG1293677-PDA
	BV Bureau Veritas S.A.	07436/E0 BV
	LR Lloyds Register	91/20112 (E9)

Compatible products

Marking accessories

	Item no.: 2009-115 WMB-Inline; for smartPRINTER; on reel; stretchable 5 - 5.2 mm; plain; snap-on type	www.wago.com/2009-115
	Item no.: 2009-115/000-002 WMB-Inline; for smartPRINTER; on reel; stretchable 5 - 5.2 mm; plain; snap-on type	www.wago.com/2009-115/000-002
	Item no.: 2009-115/000-006 WMB-Inline; for smartPRINTER; on reel; stretchable 5 - 5.2 mm; plain; snap-on type	www.wago.com/2009-115/000-006

	Item no.: 2009-115/000-007 WMB-Inline; for smartPRINTER; on reel; stretchable 5 - 5.2 mm; plain; snap-on type	www.wago.com/2009-115/000-007
	Item no.: 2009-115/000-012 WMB-Inline; for smartPRINTER; on reel; stretchable 5 - 5.2 mm; plain; snap-on type	www.wago.com/2009-115/000-012
	Item no.: 2009-115/000-017 WMB-Inline; for smartPRINTER; on reel; stretchable 5 - 5.2 mm; plain; snap-on type	www.wago.com/2009-115/000-017
	Item no.: 2009-115/000-023 WMB-Inline; for smartPRINTER; on reel; stretchable 5 - 5.2 mm; plain; snap-on type	www.wago.com/2009-115/000-023
	Item no.: 2009-115/000-024 WMB-Inline; for smartPRINTER; on reel; stretchable 5 - 5.2 mm; plain; snap-on type	www.wago.com/2009-115/000-024
	Item no.: 793-501 WMB marking card; as card; not stretchable; plain; snap-on type	www.wago.com/793-501
	Item no.: 793-501/000-002 WMB marking card; as card; not stretchable; plain; snap-on type	www.wago.com/793-501/000-002
	Item no.: 793-501/000-005 WMB marking card; as card; not stretchable; plain; snap-on type	www.wago.com/793-501/000-005
	Item no.: 793-501/000-006 WMB marking card; as card; not stretchable; plain; snap-on type	www.wago.com/793-501/000-006
	Item no.: 793-501/000-007 WMB marking card; as card; not stretchable; plain; snap-on type	www.wago.com/793-501/000-007
	Item no.: 793-501/000-012 WMB marking card; as card; not stretchable; plain; snap-on type	www.wago.com/793-501/000-012
	Item no.: 793-501/000-017 WMB marking card; as card; not stretchable; plain; snap-on type	www.wago.com/793-501/000-017
	Item no.: 793-501/000-023 WMB marking card; as card; not stretchable; plain; snap-on type	www.wago.com/793-501/000-023
	Item no.: 793-501/000-024 WMB marking card; as card; not stretchable; plain; snap-on type	www.wago.com/793-501/000-024
	Item no.: 793-5501 WMB marking card; as card; for terminal block width 5 - 17.5 mm; stretchable 5 - 5.2 mm; plain; snap-on type	www.wago.com/793-5501

**Item no.: 793-5501/000-002**

WMB marking card; as card; for terminal block width 5 - 17.5 mm; stretchable 5 - 5.2 mm; plain; snap-on type

www.wago.com/793-5501/000-002**Item no.: 793-5501/000-005**

WMB marking card; as card; stretchable 5 - 5.2 mm; plain; snap-on type

www.wago.com/793-5501/000-005**Item no.: 793-5501/000-006**

WMB marking card; as card; stretchable 5 - 5.2 mm; plain; snap-on type

www.wago.com/793-5501/000-006**Item no.: 793-5501/000-007**

WMB marking card; as card; stretchable 5 - 5.2 mm; plain; snap-on type

www.wago.com/793-5501/000-007**Item no.: 793-5501/000-012**

WMB marking card; as card; stretchable 5 - 5.2 mm; plain; snap-on type

www.wago.com/793-5501/000-012**Item no.: 793-5501/000-017**

WMB marking card; as card; stretchable 5 - 5.2 mm; plain; snap-on type



















www.wago.com/793-5501/000-017**Item no.: 793-5501/000-023**

WMB marking card; as card; stretchable 5 - 5.2 mm; plain; snap-on type

www.wago.com/793-5501/000-023**Item no.: 793-5501/000-024**

WMB marking card; as card; stretchable 5 - 5.2 mm; plain; snap-on type

www.wago.com/793-5501/000-024**ferrule****Item no.: 216-106**Ferrule; Sleeve for 2.5 mm² / AWG 14; uninsulated; electro-tin platedwww.wago.com/216-106**Item no.: 216-201**Ferrule; Sleeve for 0.5 mm² / AWG 22; insulated; electro-tin platedwww.wago.com/216-201**Item no.: 216-202**Ferrule; Sleeve for 0.75 mm² / AWG 20; insulated; electro-tin platedwww.wago.com/216-202**Item no.: 216-203**Ferrule; Sleeve for 1 mm² / AWG 18; insulated; electro-tin platedwww.wago.com/216-203**Item no.: 216-204**Ferrule; Sleeve for 1.5 mm² / AWG 16; insulated; electro-tin platedwww.wago.com/216-204**Item no.: 216-205**Ferrule; Sleeve for 2.08 mm² / AWG 14; insulated; electro-tin platedwww.wago.com/216-205**Item no.: 216-206**Ferrule; Sleeve for 2.5 mm² / AWG 14; insulated; electro-tin platedwww.wago.com/216-206**Item no.: 216-241**Ferrule; Sleeve for 0.5 mm² / AWG 22; insulated; electro-tin plated; electrolytic copper; gastight crimped; acc. to DIN 46228, Part 4/09.90www.wago.com/216-241

	Item no.: 216-242 Ferrule; Sleeve for 0.75 mm ² / AWG 20; insulated; electro-tin plated; electrolytic copper; gastight crimped; acc. to DIN 46228, Part 4/09.90	www.wago.com/216-242
	Item no.: 216-243 Ferrule; Sleeve for 1 mm ² / AWG 18; insulated; electro-tin plated; electrolytic copper; gastight crimped; acc. to DIN 46228, Part 4/09.90	www.wago.com/216-243
	Item no.: 216-244 Ferrule; Sleeve for 1.5 mm ² / AWG 16; insulated; electro-tin plated; electrolytic copper; gastight crimped; acc. to DIN 46228, Part 4/09.90	www.wago.com/216-244
	Item no.: 216-246 Ferrule; Sleeve for 2.5 mm ² / AWG 14; insulated; electro-tin plated; electrolytic copper; gastight crimped; acc. to DIN 46228, Part 4/09.90	www.wago.com/216-246
	Item no.: 216-301 Ferrule; Sleeve for 0.25 mm ² / AWG 24; insulated; electro-tin plated	www.wago.com/216-301
	Item no.: 216-302 Ferrule; Sleeve for 0.34 mm ² / AWG 24; insulated; electro-tin plated	www.wago.com/216-302
Jumper		
	Item no.: 210-103 Wire commoning chain; insulated; 50 connections	www.wago.com/210-103
	Item no.: 210-123 Wire commoning chain; insulated; 50 connections	www.wago.com/210-123
	Item no.: 249-123 Push-in type wire jumper; insulated; wire length 180 mm; Conductor cross section 0.75 mm ²	www.wago.com/249-123
	Item no.: 249-125 Push-in type wire jumper; insulated; wire length 60 mm; Conductor cross section 0.75 mm ²	www.wago.com/249-125
	Item no.: 249-126 Push-in type wire jumper; insulated; wire length 110 mm; Conductor cross section 0.75 mm ²	www.wago.com/249-126
	Item no.: 249-127 Push-in type wire jumper; insulated; wire length 250 mm; Conductor cross section 0.75 mm ²	www.wago.com/249-127
	Item no.: 281-482 Comb-style jumper bar; insulated; 2-way; IN = IN terminal block	www.wago.com/281-482
	Item no.: 281-483 Comb-style jumper bar; insulated; 3-way; IN = IN terminal block	www.wago.com/281-483
	Item no.: 281-485 Comb-style jumper bar; insulated; 5-way; IN = IN terminal block	www.wago.com/281-485
	Item no.: 281-490 Comb-style jumper bar; insulated; 10-way; IN = IN terminal block	www.wago.com/281-490
	Item no.: 281-492 Alternate comb-style jumper bar; insulated; 2-way; IN = IN terminal block	www.wago.com/281-492
	Item no.: 709-110 Wire commoning chain; insulated; 4 connections; 3 x 110 mm	www.wago.com/709-110
	Item no.: 709-111	



Wire commoning chain; insulated; 3 connections; 2 x 120 mm

www.wago.com/709-111**Item no.: 709-112**

Wire commoning chain; insulated; 3 connections; 2 x 170 mm

www.wago.com/709-112**Protective Warning Marker****Item no.: 281-415**

Protective warning marker; with high-voltage symbol, black; for 5 terminal blocks

www.wago.com/281-415**Carrier rail****Item no.: 210-112**

Steel carrier rail; 35 x 7.5 mm; 1 mm thick; 2 m long; slotted; according to EN 60715; Hole width 25 mm

www.wago.com/210-112**Item no.: 210-113**

Steel carrier rail; 35 x 7.5 mm; 1 mm thick; 2 m long; unslotted; according to EN 60715

www.wago.com/210-113**Item no.: 210-114**

Steel carrier rail; 35 x 15 mm; 1.5 mm thick; 2 m long; unslotted; similar to EN 60715

www.wago.com/210-114**Item no.: 210-115**

Steel carrier rail; 35 x 7.5 mm; 1 mm thick; 2 m long; slotted; according to EN 60715; Hole width 18 mm

www.wago.com/210-115**Item no.: 210-118**

Steel carrier rail; 35 x 15 mm; 2.3 mm thick; 2 m long; unslotted; according to EN 60715

www.wago.com/210-118**Item no.: 210-196**

Aluminum carrier rail; 35 x 8.2 mm; 1.6 mm thick; 2 m long; unslotted; similar to EN 60715

www.wago.com/210-196**Item no.: 210-197**

Steel carrier rail; 35 x 15 mm; 1.5 mm thick; 2 m long; slotted; similar to EN 60715

www.wago.com/210-197**Item no.: 210-198**

Copper carrier rail; 35 x 15 mm; 2.3 mm thick; 2 m long; unslotted; according to EN 60715

www.wago.com/210-198**Item no.: 210-504**

Steel carrier rail; 35 x 7.5 mm; 1 mm thick; 2 m long; slotted; galvanized; according to EN 60715

www.wago.com/210-504**Item no.: 210-505**

Steel carrier rail; 35 x 7.5 mm; 1 mm thick; 2 m long; unslotted; galvanized; according to EN 60715

www.wago.com/210-505**Item no.: 210-506**

Steel carrier rail; 35 x 15 mm; 1.5 mm thick; 2 m long; unslotted; galvanized; similar to EN 60715

www.wago.com/210-506**Item no.: 210-508**

Steel carrier rail; 35 x 15 mm; 1.5 mm thick; 2 m long; slotted; galvanized; similar to EN 60715

www.wago.com/210-508**tools****Item no.: 210-657**

Operating tool with partially insulated shaft; Blade (3.5 x 0.5) mm; short

www.wago.com/210-657**Item no.: 210-658**

Operating tool with partially insulated shaft; Blade (3.5 x 0.5) mm; short; angled

www.wago.com/210-658



Item no.: 210-720
Operating tool with partially insulated shaft; Type 2, blade (3.5 x 0.5) mm

www.wago.com/210-720

End plate



Item no.: 281-328
End and intermediate plate; 2.5 mm thick

www.wago.com/281-328



Item no.: 281-329
End and intermediate plate; 2.5 mm thick

www.wago.com/281-329



Item no.: 281-330
Separator plate; 2 mm thick; oversized

www.wago.com/281-330



Item no.: 281-331
Separator plate; 2 mm thick; oversized

www.wago.com/281-331

Insulation stop



Item no.: 281-470
Insulation stop; 0.08 - 0.2 mm² "s" (0.14 mm² "f-st"); 5 pieces/strip

www.wago.com/281-470



Item no.: 281-471
Insulation stop; 0.25 - 0.5 mm²; 5 pieces/strip

www.wago.com/281-471



Item no.: 281-472
Insulation stop; 0.75 - 1.5 mm²; 5 pieces/strip

www.wago.com/281-472

assembling



Item no.: 209-106
Mounting carrier; for isolated mounting on DIN 35 rails

www.wago.com/209-106



Item no.: 709-153
Cover; Type 1; suitable for cover carrier, type 1; 1 m long

www.wago.com/709-153

General accessories



Item no.: 209-107
Test socket; insulated; 2 mm Ø

www.wago.com/209-107



Item no.: 209-108
Test socket; insulated; 2.3 mm Ø

www.wago.com/209-108



Item no.: 249-105
Group marker carrier

www.wago.com/249-105



Item no.: 709-170
Disconnect lock; for disconnect tab used on 280/281 and 769 Series disconnect terminal blocks

www.wago.com/709-170

Downloads

Documentation

Bid Text

281-912



Oct 12, 2017

DOC
24.6 kB

Download

Subject to changes.

WAGO Kontakttechnik GmbH & Co. KG
Hansastr. 27
32423 Minden
Phone: +49571 887-0 | Fax: +49571 887-169
Email: info.de@wago.com | Web: www.wago.com

Do you have any questions about our products?
We are always happy to take your call at +49 (571) 887-44222.