

Data sheet | Item number: 282-641

Ground conductor disconnect terminal block; with test option; with orange disconnect link; 48 V; 6 mm²; CAGE CLAMP®

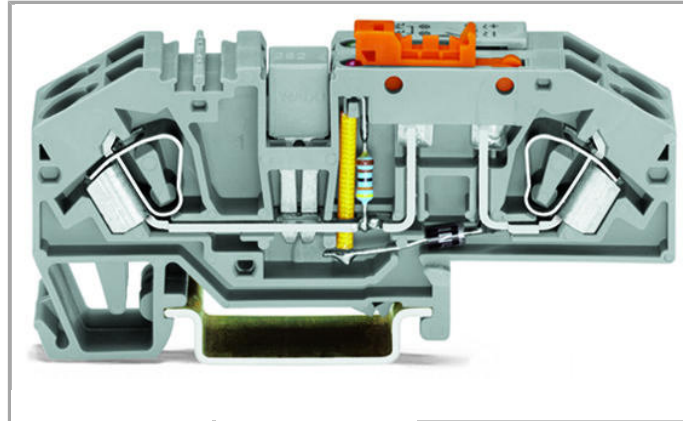

www.wago.com/282-641



RoHS Compliant

BOMcheck.net

Color: ■

Data

Electrical data

Ratings per IEC/EN 60664-1

Legend (ratings)

(III / 3) ≙ Overvoltage category III / Pollution degree 3

Connection data

Connection technology	CAGE CLAMP®
Actuation type	Operating tool
Connectable conductor materials	Copper Aluminum
Solid conductor	0.2 ... 6 mm ² / 24 ... 10 AWG
Fine-stranded conductor	0.2 ... 6 mm ² / 24 ... 10 AWG
Strip length	12 ... 13 mm / 0.47 ... 0.51 Inch
Total number of connection points	4
Total number of potentials	4
Number of levels	1
Type of wiring	Front-entry wiring

Geometrical Data

Width	16 mm / 0.63 inch
-------	-------------------

Height from upper-edge of DIN-35 rail	37 mm / 1.457 inch
Depth	85 mm / 3.346 inch

Mechanical data

Design	angled
Type of mounting	DIN-35 rail
Marking level	Center marking

Material Data

Color	gray
Weight	40.7 g

Commercial data

Country of origin	DE
GTIN	4050821666028
Customs Tariff No.	85365080990
Product Group	1 (Rail Mounted Terminal Blocks)

Approvals / Certificates

Country specific Approvals

Logo	Approval	Certificate name
	CCA DEKRA Certification B.V.	2195540.01
	CCA DEKRA Certification B.V.	2195540.01
	CCA DEKRA Certification B.V.	NTR NL-7522

UL-Approvals



Logo	Approval	Certificate name
	UR Underwriters Laboratories Inc.	E45172

Compatible products











tools

	Item no.: 210-721 Operating tool with partially insulated shaft; Type 3, blade (5.5 x 0.8) mm	www.wago.com/210-721
--	---	--

General accessories

	Item no.: 209-143 Group marker carrier	www.wago.com/209-143
	Item no.: 209-144 Group marker carrier	www.wago.com/209-144
	Item no.: 249-105 Group marker carrier	www.wago.com/249-105

Marking accessories

	Item no.: 2009-115 WMB-Inline; for smartPRINTER; on reel; stretchable 5 - 5.2 mm; plain; snap-on type	www.wago.com/2009-115
	Item no.: 2009-115/000-002 WMB-Inline; for smartPRINTER; on reel; stretchable 5 - 5.2 mm; plain; snap-on type	www.wago.com/2009-115/000-002
	Item no.: 2009-115/000-006 WMB-Inline; for smartPRINTER; on reel; stretchable 5 - 5.2 mm; plain; snap-on type	www.wago.com/2009-115/000-006
	Item no.: 2009-115/000-007 WMB-Inline; for smartPRINTER; on reel; stretchable 5 - 5.2 mm; plain; snap-on type	www.wago.com/2009-115/000-007
	Item no.: 2009-115/000-012 WMB-Inline; for smartPRINTER; on reel; stretchable 5 - 5.2 mm; plain; snap-on type	www.wago.com/2009-115/000-012
	Item no.: 2009-115/000-017 WMB-Inline; for smartPRINTER; on reel; stretchable 5 - 5.2 mm; plain; snap-on type	www.wago.com/2009-115/000-017
	Item no.: 2009-115/000-023 WMB-Inline; for smartPRINTER; on reel; stretchable 5 - 5.2 mm; plain; snap-on type	www.wago.com/2009-115/000-023
	Item no.: 2009-115/000-024 WMB-Inline; for smartPRINTER; on reel; stretchable 5 - 5.2 mm; plain; snap-on type	www.wago.com/2009-115/000-024
	Item no.: 793-501 WMB marking card; as card; not stretchable; plain; snap-on type	www.wago.com/793-501
	Item no.: 793-501/000-002 WMB marking card; as card; not stretchable; plain; snap-on type	www.wago.com/793-501/000-002



Item no.: 793-501/000-005
WMB marking card; as card; not stretchable; plain; snap-on type

www.wago.com/793-501/000-005



Item no.: 793-501/000-006
WMB marking card; as card; not stretchable; plain; snap-on type

www.wago.com/793-501/000-006



Item no.: 793-501/000-007
WMB marking card; as card; not stretchable; plain; snap-on type

www.wago.com/793-501/000-007



Item no.: 793-501/000-012
WMB marking card; as card; not stretchable; plain; snap-on type

www.wago.com/793-501/000-012



Item no.: 793-501/000-017
WMB marking card; as card; not stretchable; plain; snap-on type

www.wago.com/793-501/000-017



Item no.: 793-501/000-023
WMB marking card; as card; not stretchable; plain; snap-on type

www.wago.com/793-501/000-023



Item no.: 793-501/000-024
WMB marking card; as card; not stretchable; plain; snap-on type

www.wago.com/793-501/000-024



Item no.: 793-5501
WMB marking card; as card; for terminal block width 5 - 17.5 mm; stretchable 5 - 5.2 mm; plain; snap-on type

www.wago.com/793-5501



Item no.: 793-5501/000-002
WMB marking card; as card; for terminal block width 5 - 17.5 mm; stretchable 5 - 5.2 mm; plain; snap-on type

www.wago.com/793-5501/000-002



Item no.: 793-5501/000-005
WMB marking card; as card; stretchable 5 - 5.2 mm; plain; snap-on type

www.wago.com/793-5501/000-005



Item no.: 793-5501/000-006
WMB marking card; as card; stretchable 5 - 5.2 mm; plain; snap-on type

www.wago.com/793-5501/000-006



Item no.: 793-5501/000-007
WMB marking card; as card; stretchable 5 - 5.2 mm; plain; snap-on type

www.wago.com/793-5501/000-007



Item no.: 793-5501/000-012
WMB marking card; as card; stretchable 5 - 5.2 mm; plain; snap-on type

www.wago.com/793-5501/000-012



Item no.: 793-5501/000-014
WMB marking card; as card; stretchable 5 - 5.2 mm; plain; snap-on type

www.wago.com/793-5501/000-014



Item no.: 793-5501/000-017
WMB marking card; as card; stretchable 5 - 5.2 mm; plain; snap-on type

www.wago.com/793-5501/000-017



Item no.: 793-5501/000-023
WMB marking card; as card; stretchable 5 - 5.2 mm; plain; snap-on type

www.wago.com/793-5501/000-023



Item no.: 793-5501/000-024
WMB marking card; as card; stretchable 5 - 5.2 mm; plain; snap-on type

www.wago.com/793-5501/000-024

ferrule



Item no.: 216-262
Ferrule; Sleeve for 0.75 mm² / AWG 20; insulated; electro-tin plated; electrolytic copper; gastight crimped; acc. to DIN 46228, Part 4/09.90

www.wago.com/216-262



Item no.: 216-263
Ferrule; Sleeve for 1 mm² / AWG 18; insulated; electro-tin plated; electrolytic copper; gastight crimped; acc. to DIN 46228, Part 4/09.90

www.wago.com/216-263



Item no.: 216-264
Ferrule; Sleeve for 1.5 mm² / AWG 16; insulated; electro-tin plated; electrolytic copper; gastight crimped; acc. to DIN 46228, Part 4/09.90

www.wago.com/216-264



Item no.: 216-266
Ferrule; Sleeve for 2.5 mm² / AWG 14; insulated; electro-tin plated; electrolytic copper; gastight crimped; acc. to DIN 46228, Part 4/09.90

www.wago.com/216-266



Item no.: 216-267
Ferrule; Sleeve for 4 mm² / AWG 12; insulated; electro-tin plated; electrolytic copper; gastight crimped; acc. to DIN 46228, Part 4/09.90

www.wago.com/216-267

Protective Warning Marker



Item no.: 282-405
Protective warning marker; with high-voltage symbol, black; for 5 terminal blocks

www.wago.com/282-405

assembling



Item no.: 209-106
Mounting carrier; for isolated mounting on DIN 35 rails

www.wago.com/209-106



Item no.: 709-154
Cover; Type 2; suitable for cover carrier, type 2; 1 m long

www.wago.com/709-154

check



Item no.: 209-170
Test plug adapter; 8.3 mm wide; for 4 mm Ø test plugs; suitable for 1.5 mm² - 10 mm² tbs

www.wago.com/209-170



Item no.: 210-136
Test plug; 2 mm Ø; with 500 mm cable

www.wago.com/210-136

Carrier rail





















Item no.: 210-112
Steel carrier rail; 35 x 7.5 mm; 1 mm thick; 2 m long; slotted; according to EN 60715; "Hole width 25 mm

www.wago.com/210-112



Item no.: 210-113
Steel carrier rail; 35 x 7.5 mm; 1 mm thick; 2 m long; unslotted; according to EN 60715

www.wago.com/210-113

	Item no.: 210-114 Steel carrier rail; 35 x 15 mm; 1.5 mm thick; 2 m long; unslotted; similar to EN 60715	www.wago.com/210-114
	Item no.: 210-115 Steel carrier rail; 35 x 7.5 mm; 1 mm thick; 2 m long; slotted; according to EN 60715; "Hole width 18 mm	www.wago.com/210-115
	Item no.: 210-118 Steel carrier rail; 35 x 15 mm; 2.3 mm thick; 2 m long; unslotted; according to EN 60715	www.wago.com/210-118
	Item no.: 210-196 Aluminum carrier rail; 35 x 8.2 mm; 1.6 mm thick; 2 m long; unslotted; similar to EN 60715	www.wago.com/210-196
	Item no.: 210-197 Steel carrier rail; 35 x 15 mm; 1.5 mm thick; 2 m long; slotted; similar to EN 60715	www.wago.com/210-197
	Item no.: 210-198 Copper carrier rail; 35 x 15 mm; 2.3 mm thick; 2 m long; unslotted; according to EN 60715	www.wago.com/210-198
	Item no.: 210-504 Steel carrier rail; 35 x 7.5 mm; 1 mm thick; 2 m long; slotted; galvanized; according to EN 60715	www.wago.com/210-504
	Item no.: 210-505 Steel carrier rail; 35 x 7.5 mm; 1 mm thick; 2 m long; unslotted; galvanized; according to EN 60715	www.wago.com/210-505
	Item no.: 210-506 Steel carrier rail; 35 x 15 mm; 1.5 mm thick; 2 m long; unslotted; galvanized; similar to EN 60715	www.wago.com/210-506
	Item no.: 210-508 Steel carrier rail; 35 x 15 mm; 1.5 mm thick; 2 m long; slotted; galvanized; similar to EN 60715	www.wago.com/210-508
End plate		
	Item no.: 282-333 End plate; 2 mm thick	www.wago.com/282-333
	Item no.: 282-334 End plate; 2 mm thick	www.wago.com/282-334
Jumper		
	Item no.: 210-103 Wire commoning chain; insulated; 50 connections	www.wago.com/210-103
	Item no.: 210-123 Wire commoning chain; insulated; 50 connections	www.wago.com/210-123
	Item no.: 282-402 Adjacent jumper; insulated; Nominal current 41 A	www.wago.com/282-402
	Item no.: 282-409 Alternate jumper; insulated; Nominal current 41 A	www.wago.com/282-409
	Item no.: 282-422 Adjacent jumper; insulated; Nominal current 41 A	www.wago.com/282-422
	Item no.: 282-424 Adjacent jumper; insulated; Nominal current 41 A	www.wago.com/282-424



Item no.: 709-110
Wire commoning chain; insulated; 4 connections; 3 x 110 mm

www.wago.com/709-110



Item no.: 709-111
Wire commoning chain; insulated; 3 connections; 2 x 120 mm

www.wago.com/709-111



Item no.: 709-112
Wire commoning chain; insulated; 3 connections; 2 x 170 mm

www.wago.com/709-112

protection



Item no.: 282-415
Protective warning marker; with high-voltage symbol, black; for 5 terminal blocks

www.wago.com/282-415

Downloads

Documentation

Bid Text

282-641	Oct 12, 2017	DOC 24.6 kB	Download
---------	--------------	----------------	----------

smartDATA

CAD data

3D Download 282-641	URL	Download
---------------------	-----	----------

Subject to changes.