

**HEADER RIGHT ANGLE SOLDER PIN,
1.2 X 1.2 MM / 0.047 X 0.047 IN PIN
SPACING 5 MM / 0.197 IN 100%
PROTECTED AGAINST MISMATING**

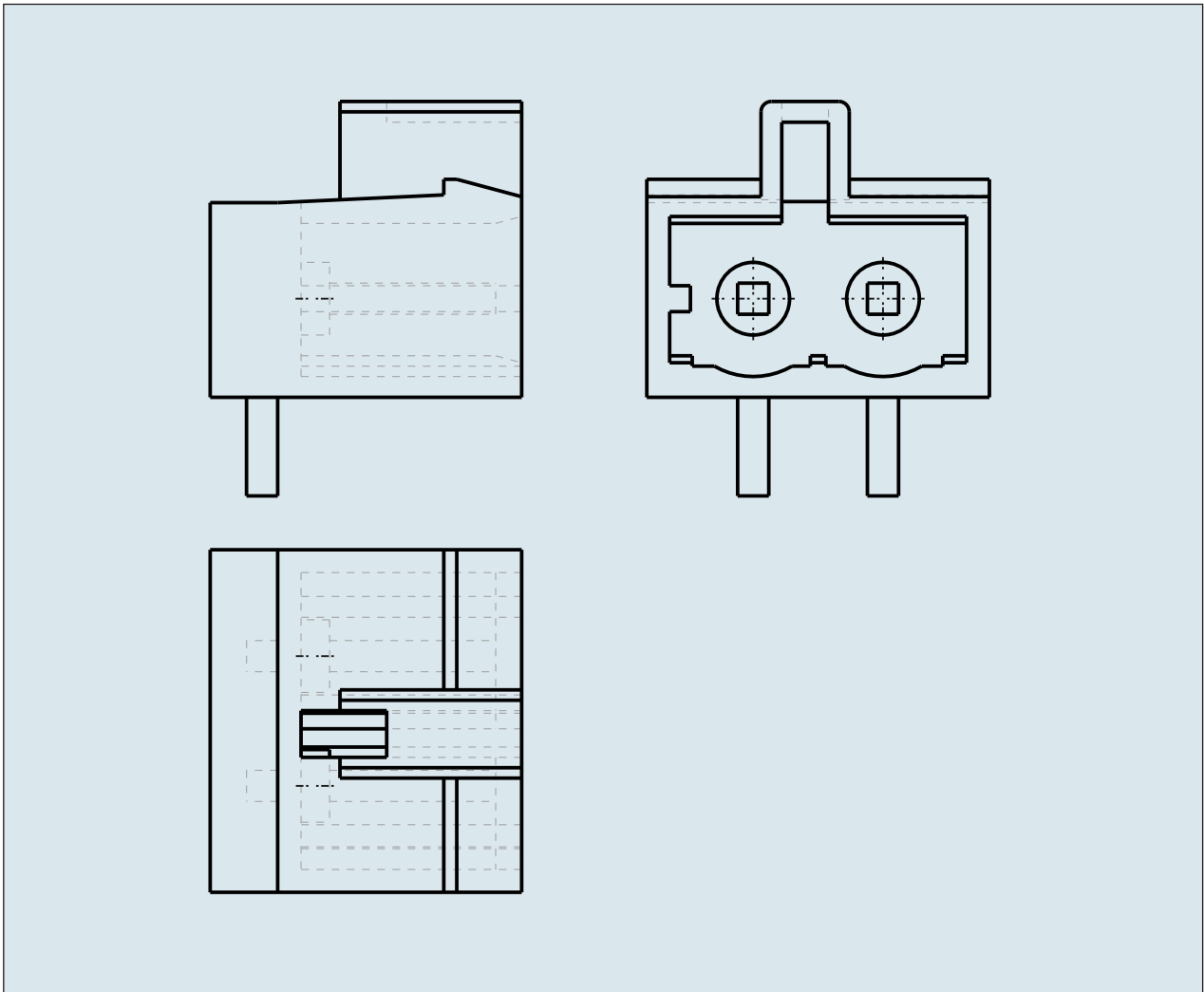
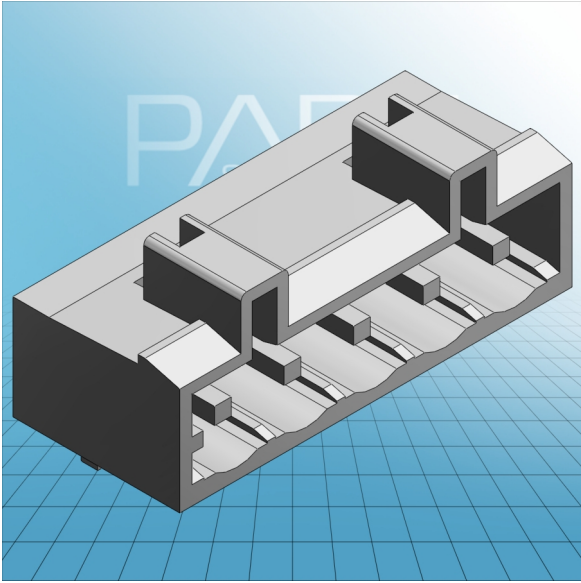

**HEADER RIGHT ANGLE SOLDER PIN,
1.2 X 1.2 MM/ 0.047 X 0.047 IN PIN
SPACING 5 MM / 0.197 IN 100%
PROTECTED AGAINST MISMATING
721-462/001-000 TO 721-480/001-000**

ITEM-NO. (ITEM-NO.)	721-465/001-000
Measured voltage (Measured voltage / V)	320
Measured shock voltage (Measured shock voltage / kV)	4
Pollution degree (Pollution degree)	2
Current intensity (Current intensity / A)	16
RM (PIN SPACING / mm)	5
P (NO. OF POLES)	5
Height (Height / mm)	11.4
Width (Width / mm)	28.2
Depth (Depth / mm)	12
COLOR (COLOR)	lichtgrau
Comment (Comment)	A = (No. of poles x Pin Spacing) + 3,2 mm B = A + 5 mm C = B + 7,4 mm
Dimensions (Dimensions)	1,7 +0,1 mm