

**MALE CONNECTOR WITH SNAP-IN  
MOUNTING FOOT 3 POLE PIN  
SPACING 7.5 MM / 0.295 IN 100%  
PROTECTED AGAINST MISMATING**

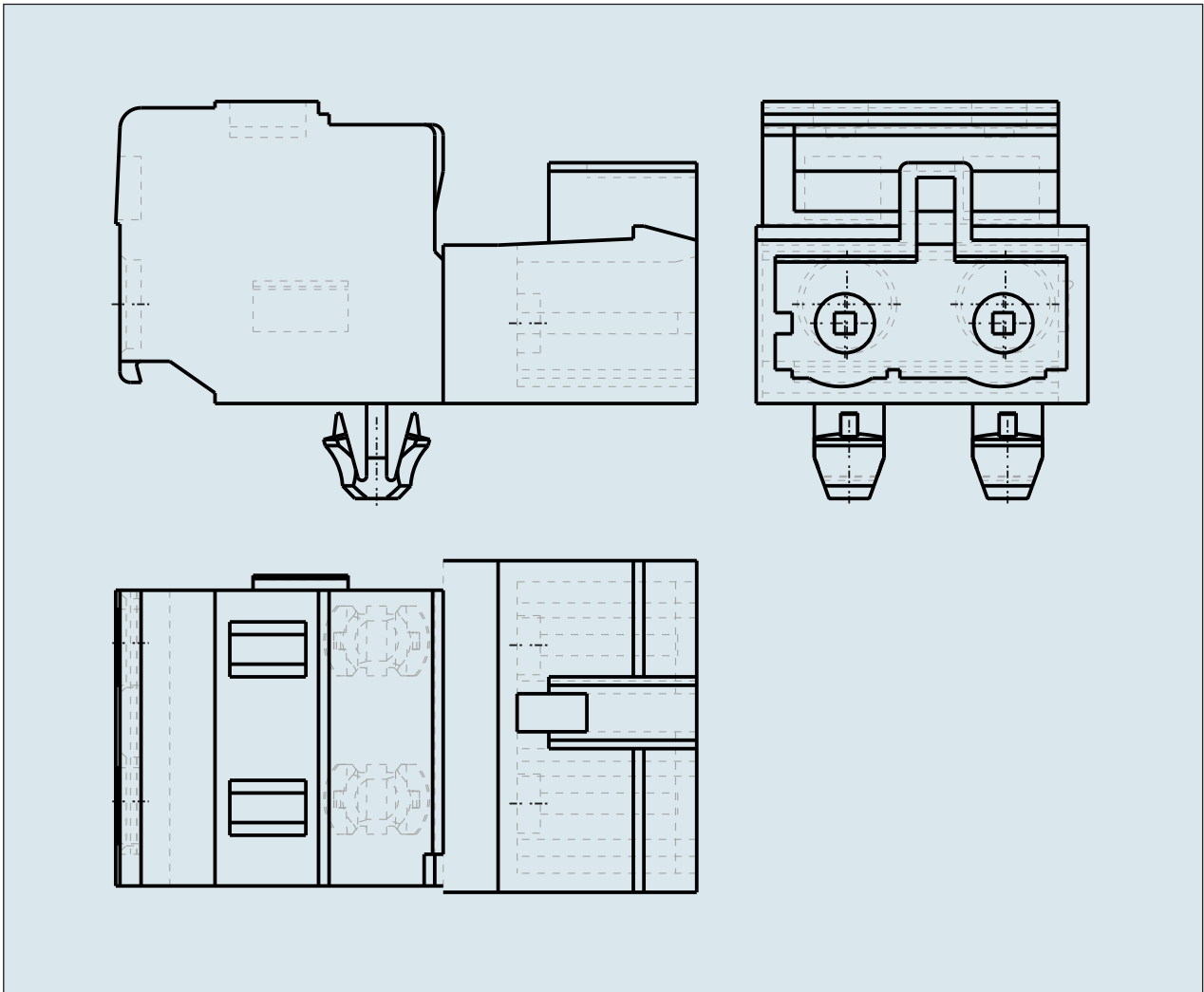
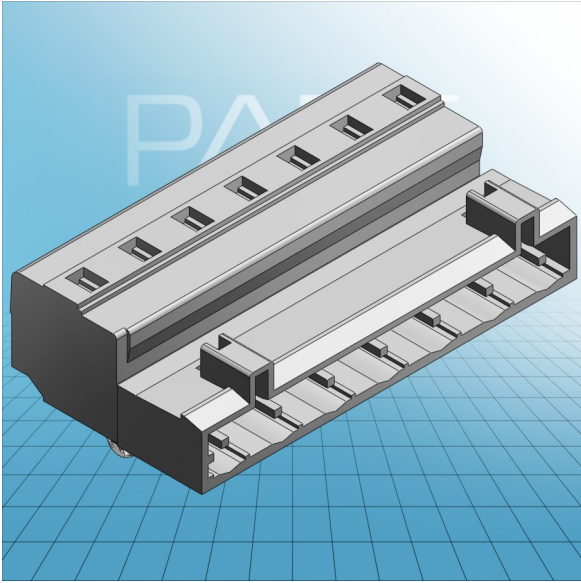

**MALE CONNECTOR WITH SNAP-IN  
MOUNTING FOOT 3 POLE PIN  
SPACING 7.5 MM / 0.295 IN 100%  
PROTECTED AGAINST MISMATING  
723-602/018-000 TO 723-612/018-000**

<b>ITEM-NO. (ITEM-NO.)</b>	723-607/018-000
<b>Cross section1 (Cross section / mm<sup>2</sup>)</b>	0.08 - 2.5
<b>Cross section2 (Cross section / AWG)</b>	28 - 12
<b>Strip length (Strip length / mm)</b>	8 - 9
<b>Measured voltage (Measured voltage / V)</b>	630
<b>Measured shock voltage (Measured shock voltage / kV)</b>	6
<b>Pollution degree (Pollution degree)</b>	2
<b>Current intensity (Current intensity / A)</b>	12
<b>RM (PIN SPACING / mm)</b>	7.5
<b>P (NO. OF POLES)</b>	7
<b>Height (Height / mm)</b>	14.3
<b>Width (Width / mm)</b>	53.2
<b>Depth (Depth / mm)</b>	27.5
<b>No. of connection Points (No. of connection Points)</b>	7
<b>No. of potentials (No. of potentials)</b>	7
<b>COLOR (COLOR)</b>	lichtgrau
<b>WEIGHT (WEIGHT / g)</b>	12.58
<b>Comment (Comment)</b>	A = (No. of poles - 1) x Pin Spacing + 5 mm + 3,2 mm   B = A - 1,7 mm   C = A -1,2 mm