

Data sheet | Item number: 756-1101/060-050

PROFIBUS cable, straight; 5 m; fitted on one end; B-coded; M12 socket, straight; one free cable end

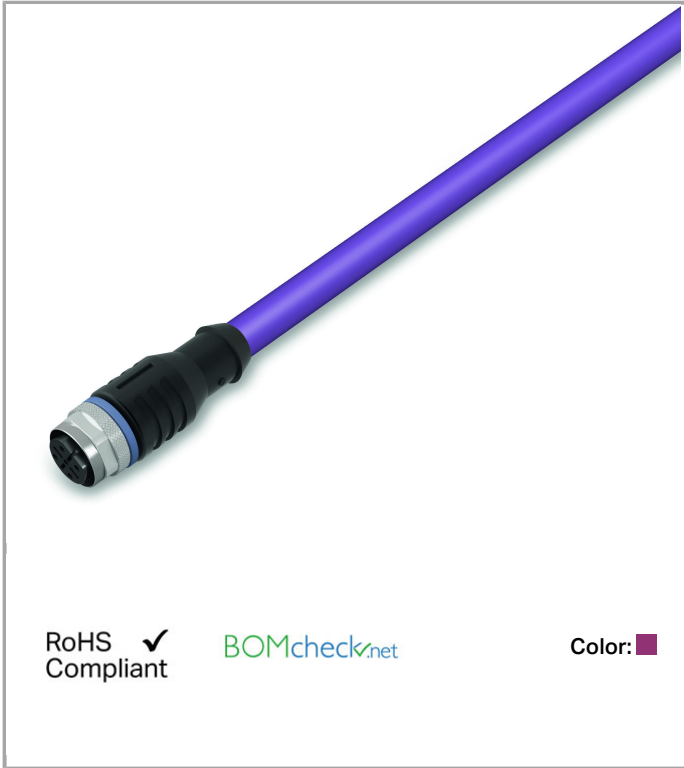

www.wago.com/756-1101/060-050



RoHS
Compliant ✓

BOMcheck.net

Color: ■

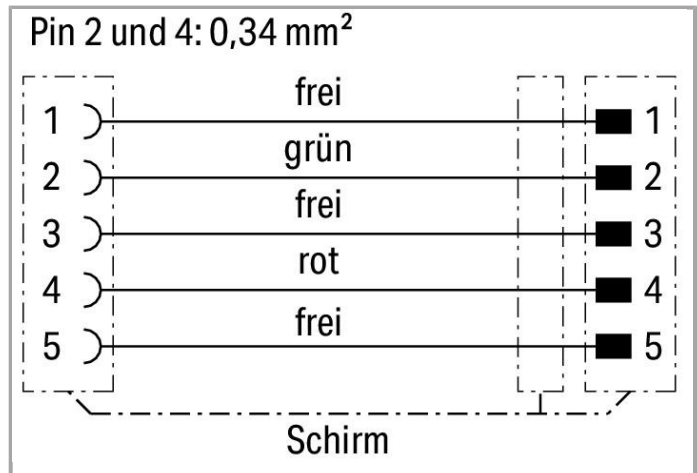
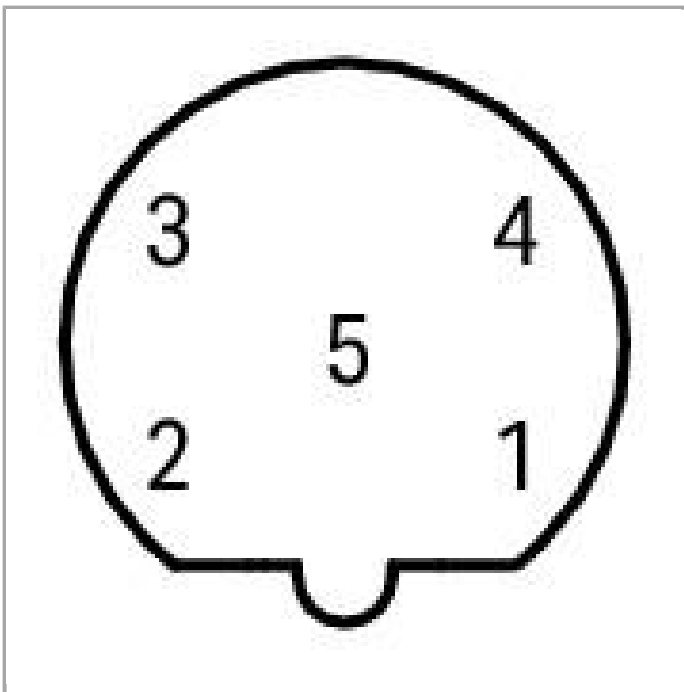
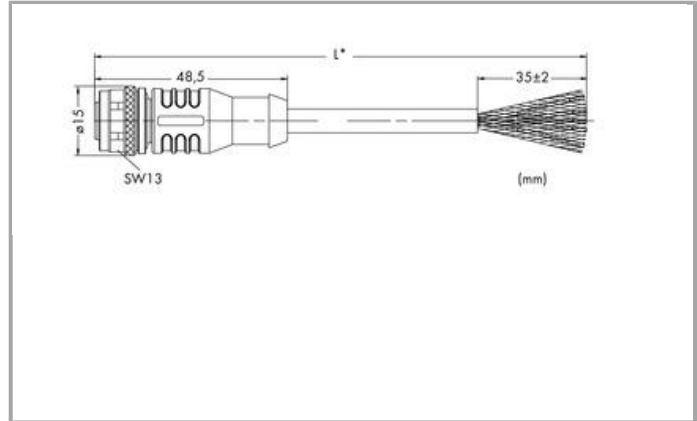

Item description

Short description:

- PUR, halogen-free
- Suitable for drag chains
- Silicon- and PVC-free
- Good resistance to microbes, hydrolysis, oil, chemicals and UV radiation
- Good chemical resistance

Data**Technical Data**

Connection type	M12 socket - free end
No. of poles	5
Leitungsanschlussrichtung zur Steckrichtung	0°
Steckgesichtskodierung Leitung/Adapter 1 1	B coded
Cable length	5 m
Communication/Fieldbus	PROFIBUS
Operating voltage	≤ 300 V
Operating current	4 A
Rated surge voltage	2 kV
Insulation resistance	> 2500 MΩ/km
Resistance of conductor	max. 55 Ω/km; Schleifenwiderstand: max. 110 Ω/km

Mechanical data

bending radius	> 10 x cable Ø (flexible use); > 5 x cable Ø in drag chain (fixed installation)
Bending cycles	1
Schleppkettentauglichkeit	yes
Durchmesser der Mantelleitung	7.3 ... 7.9 mm
Bauartkurzzeichen	LI02YS-(ST)CB11Y 1X(2X0,34SQMM)
Screening	Shielding braid, (approx. 5.90 mm Ø), tinned CU-ETP1, coverage 85 % ± 5 %
Conductor design	Bare copper wire (19 x 0.15 mm)
Leiterisolierung	PE halogenfrei; Füllstoff: PP-Garn
Housing material	TPU/TPU, black (~ RAL 9005)
Tightening torque	1 Nm
Weight	350 g
Color	violet

Environmental Requirements

Umgebungstemperatur (Betrieb) bewegt	-25 ... +60 °C
Umgebungstemperatur (Betrieb) ruhend	-50 ... +80 °C



Degree of protection	IP67
Degree of pollution (5)	3/2 per IEC 60664-1

Commercial data

Country of origin	DE
GTIN	4045454521516
Customs Tariff No.	85444290900

Downloads

Documentation

System Description

I/O-SYSTEM – <i>SPEEDWAY</i> , General Product Information	Jun 6, 2017	1.1 MB	Download
--	-------------	--------	--------------------------

Subject to changes.