

Data sheet | Item number: 756-1201/060-020

ETHERNET/PROFINET cable, straight; 2 m; fitted on one end; D-coded; M12
plug, straight; one free cable end



www.wago.com/756-1201/060-020



RoHS
Compliant ✓

BOMcheck.net

Color: ■

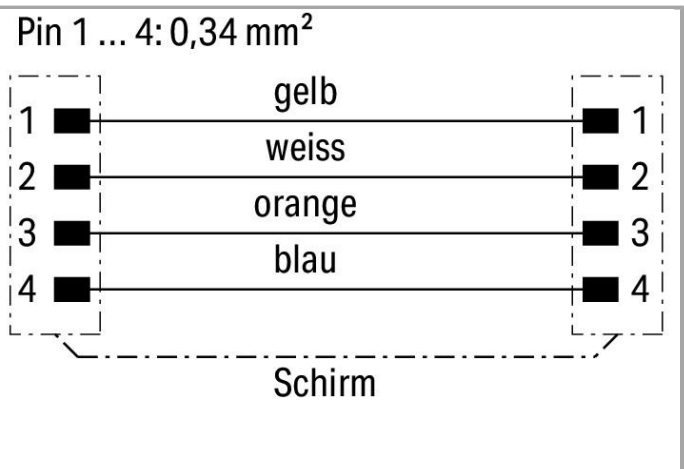
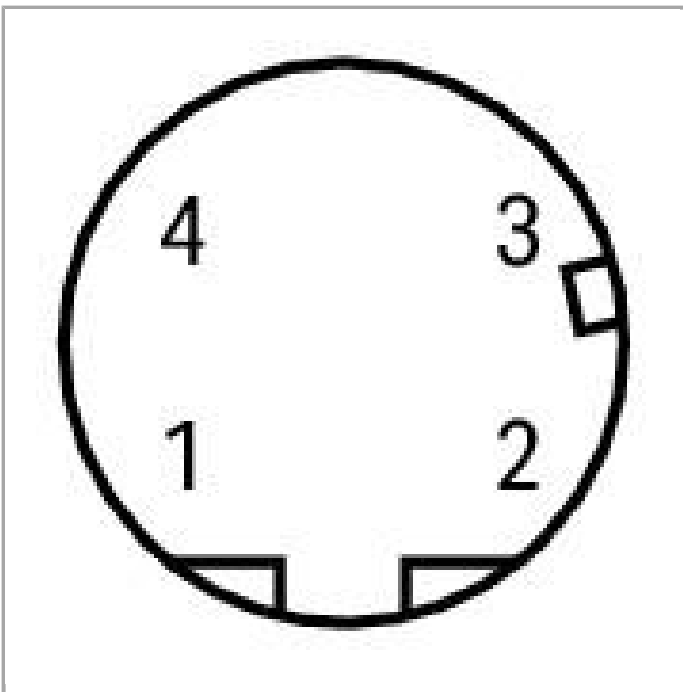
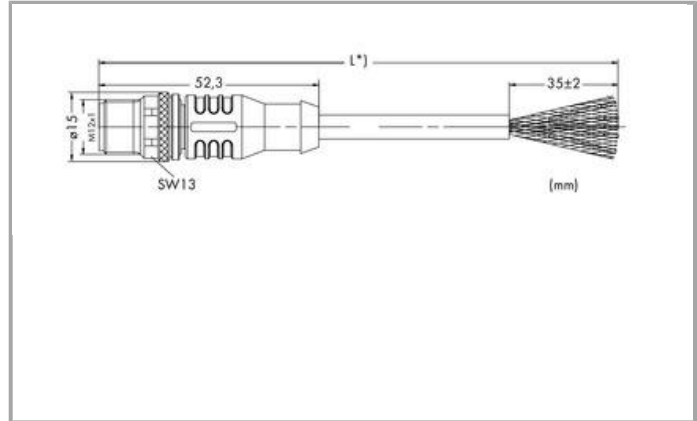

Item description

**Short description:**

- PUR GN, halogen-free
- CAT 5e ES
- Suitable for drag chains
- Silicon- and CFC-free
- Good resistance to microbes, hydrolysis, oil, ozone, chemicals and UV radiation
- Cable used: UL listed

Data**Technical Data**

Connection type	M12 plug - free end
No. of poles	4
Leitungsanschlussrichtung zur Steckrichtung	0°
Steckgesichtskodierung Leitung/Adapter 1 1	D coded
Cable length	2 m
Communication/Fieldbus	Ethernet
Communication/Fieldbus (2)	PROFINET IO
Operating voltage	250 V
Operating current	4 A
Rated surge voltage	2 kV
Contact resistance	10 MΩ
Insulation resistance	≥ 5 x 10 ⁸ Ω/km
Resistance of conductor	< 57 Ω/km

Mechanical data

bending radius	single: min. 5 x cable Ø; multiple: min. 7.5 x cable Ø
Bending cycles	3
Schleppkettentauglichkeit	yes
Durchmesser der Mantelleitung	6.3 ... 6.7 mm
Bauartkurzzeichen	02YH(ST)C11Y 2x2x0,75/1.5-100 LI GN VZN FRNC, geschirmt
Screening	Overlapped aluminum-laminated foil and tinned copper braid, optical coverage approx. 85 %
Conductor design	Bare copper wire (7 x 0.25 mm)
Leiterisolierung	PE halogenfrei
Housing material	TPU/TPU, black (~ RAL 9005)
Tightening torque	1 Nm
Weight	140 g
Color	green



Environmental Requirements

Umgebungstemperatur (Betrieb) bewegt	-40 ... +70 °C
Umgebungstemperatur (Betrieb) ruhend	-40 ... +70 °C
Degree of protection	IP67
Degree of pollution (5)	3/2 per IEC 60664-1

Commercial data

Country of origin	DE
GTIN	4045454521752
Customs Tariff No.	85444290900

Downloads

Documentation

System Description

I/O-SYSTEM – <i>SPEEDWAY</i> , General Product Information	Jun 6, 2017	1.1 MB	Download
--	-------------	--------	--------------------------

Subject to changes.