

Data sheet | Item number: 756-3104/040-200

Power supply cable, angled; 20 m; fitted on one end; A-coded; M12 plug, angled; one free cable end

[www.wago.com/756-3104/040-200](http://www.wago.com/756-3104/040-200)

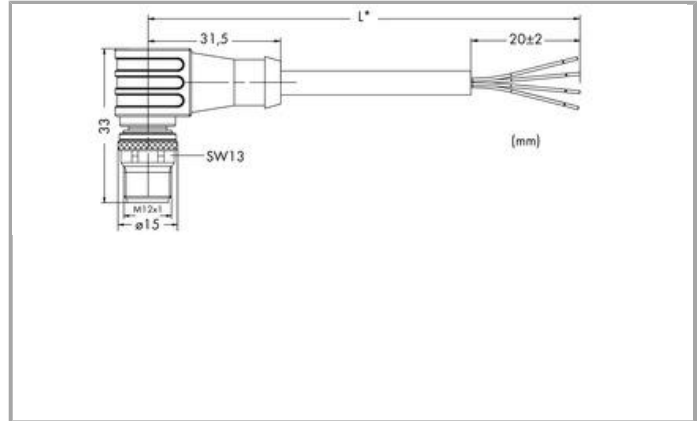

RoHS  
Compliant ✓

BOMcheck.net

Color: ■

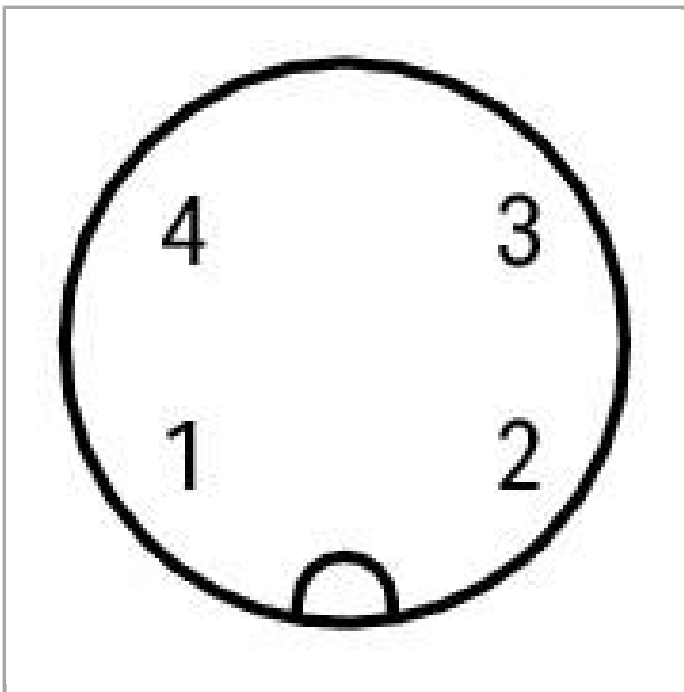

Pin 1 ... 4: 0,75 mm<sup>2</sup>

1 )	braun	■	1
2 )	weiß	■	2
3 )	blau	■	3
4 )	schwarz	■	4

Item description

**Short description:**

- PUR, halogen-free
- UL / CSA
- Suitable for drag chains
- Silicon- and CFC-free
- Good resistance to microbes, hydrolysis, oil, chemicals and UV radiation
- Good chemical resistance
- Cable used: UL listed

**Data****Technical Data**

Connection type	M12 plug - free end
No. of poles	4
Leitungsanschlussrichtung zur Steckrichtung	90°
Steckgesichtskodierung Leitung/Adapter 1 1	A coded
Cable length	20 m
Operating voltage	250 VAC/DC
Operating current	4 A
Rated surge voltage	2,5 kV
Contact resistance	10 MΩ
Isolationswiderstand	1000 MΩ
Resistance of conductor	≤ 26 Ω/km

**Mechanical data**

bending radius	min. 10 x cable Ø
Bending cycles	4
Schleppkettentauglichkeit	yes
Durchmesser der Mantelleitung	6 ... 6.4 mm
Bauartkurzzeichen	Lif9YH-11YH 4x0,75 mm <sup>2</sup>
Conductor design	Bare copper wire (40 x 0.15 mm)
Leiterisolierung	PP9Y halogenfrei
Housing material	TPU/TPU, black (~ RAL 9005)
Tightening torque	1 Nm
Weight	9.999 g
Color	gray

**Environmental Requirements**

Umgebungstemperatur (Betrieb) bewegt	-30 ... +80 °C
Umgebungstemperatur (Betrieb) ruhend	-30 ... +80 °C



Degree of protection	IP67
Degree of pollution (5)	3/2 per IEC 60664-1

### Commercial data

Country of origin	DE
GTIN	4045454772369
Customs Tariff No.	85444290900

### Downloads

#### Documentation

##### System Description

I/O-SYSTEM – <i>SPEEDWAY</i> , General Product Information	Jun 6, 2017	1.1 MB	<a href="#">Download</a>
--	-------------	--------	--------------------------

Subject to changes.