

Data sheet | Item number: 756-3204/190-150

Connecting cable; angled; 19-pole; 15 m; fitted on one end (with free end);
M23 socket, straight

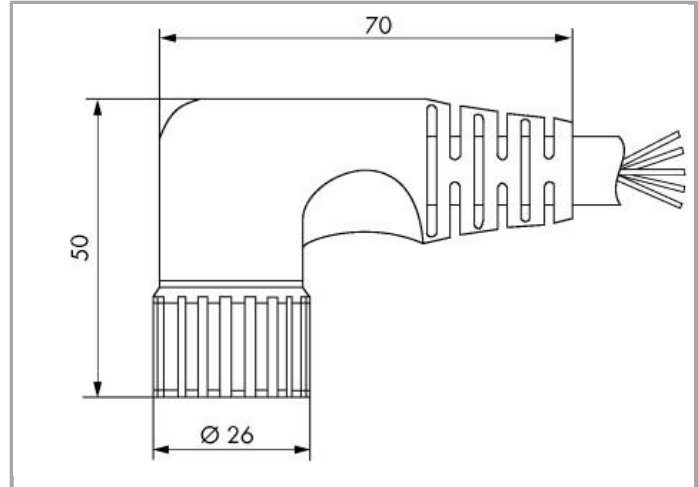

www.wago.com/756-3204/190-150



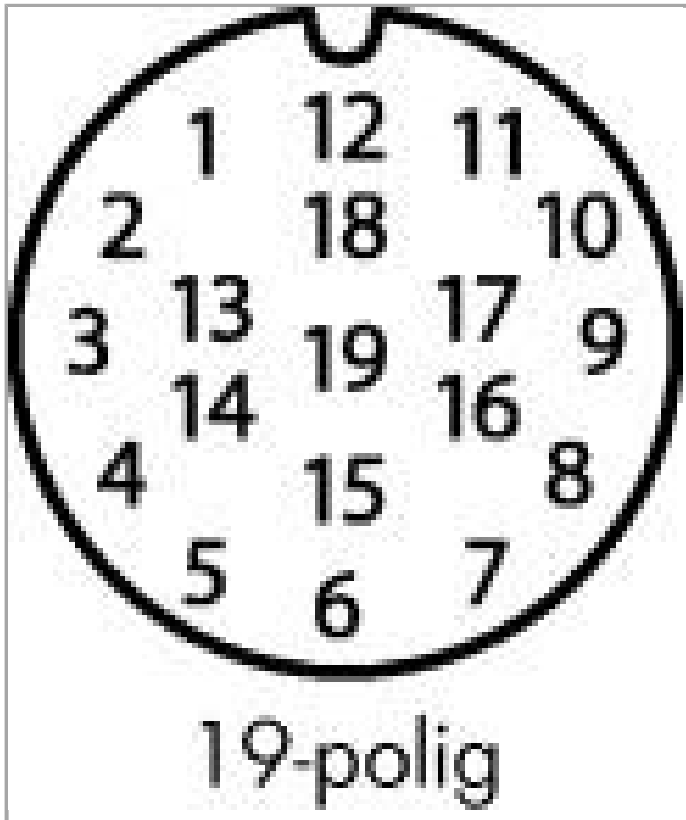

Pin 6, 12, 19: 1,00 mm²;
Pin 1 - 5, 7 - 11, 13 - 19: 0,34 mm²

1	violett	11	schwarz
2	rot	12	grün-gelb
3	grau	13	gelb-braun
4	rot-blau	14	braun-grün
5	grün	15	weiß
6	blau	16	gelb
7	grau-rosa	17	rosa
8	weiß-grün	18	grau-braun
9	weiß-gelb	19	braun
10	weiß-grau		

Data

Technical Data

Connection type	M23 socket - free end
No. of poles	19
Leitungsanschlussrichtung zur Steckrichtung	90°
Cable length	15 m
Operating voltage	≤300 V
Operating current	8 A
Operating current	10 A (1 mm ²)
Rated surge voltage	≥2,0 kV eff.

Mechanical data

Bending cycles	2
Schleppkettentauglichkeit	yes
Durchmesser der Mantelleitung	11.3 ... 11.9 mm
Weight	2152 g

Environmental Requirements

Umgebungstemperatur (Betrieb) bewegt	-25 ... +80 °C
Umgebungstemperatur (Betrieb) ruhend	-40 ... +90 °C



Degree of protection	IP67
----------------------	------

Commercial data

Country of origin	DE
GTIN	4044918569095
Customs Tariff No.	85444290900
Product Group	23 (I/O passive and accessories)

Downloads

Documentation

System Description

Sensor/Actuator Boxes – General Product Information	Jun 6, 2017	Download
		357.7 kB

Subject to changes.