

Data sheet | Item number: 756-3205/140-100

Connecting cable; for the connection of M8 sensor/actuator boxes; 14-pole;
M16 socket, straight; one free cable end; 10 m

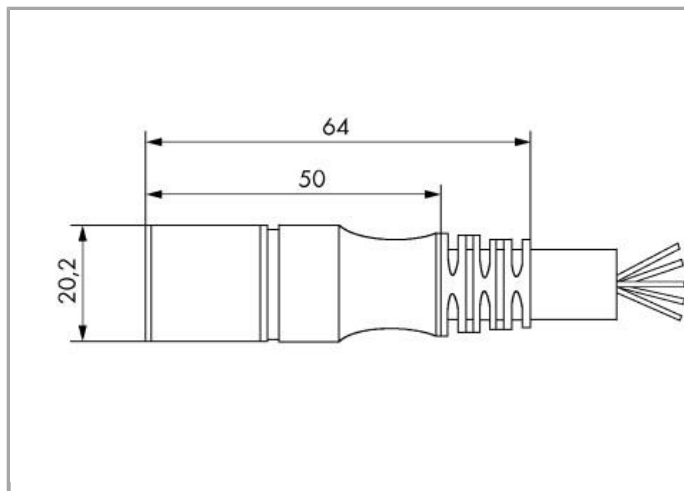

www.wago.com/756-3205/140-100

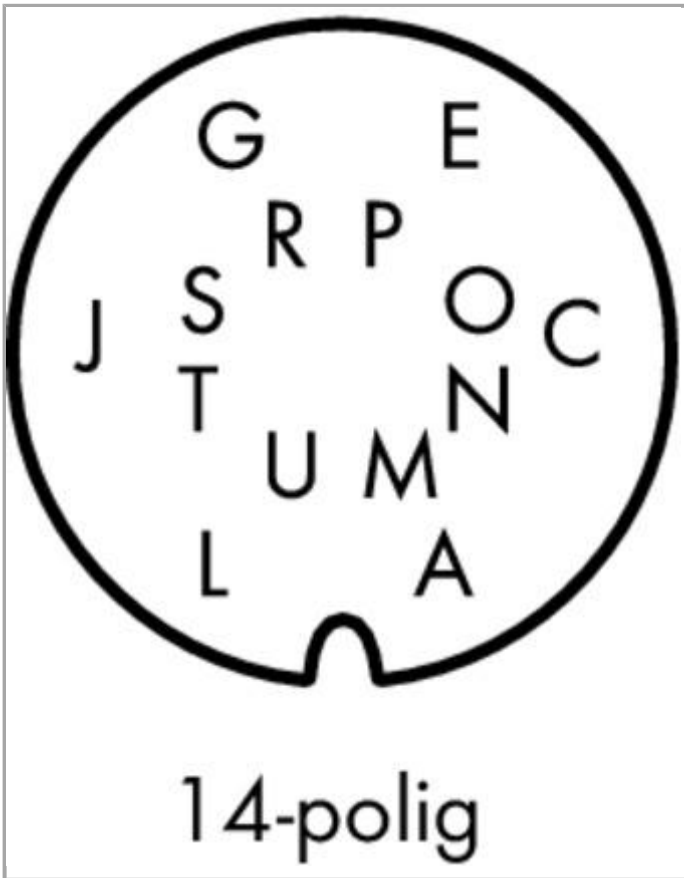

Pin A, L: 0,75 mm²Pin C - J, N - T: 0,34 mm²

A	braun	N	pink-braun
C	weiß-pink	O	violett
E	schwarz	P	weiß
G	rosa	R	rot
J	grün	S	grau
L	blau	T	gelb
M	gebrückt mit A	U	gebrückt mit L

Data**Technical Data**

Connection type	M16 socket - free end
No. of poles	14
Leitungsanschlussrichtung zur Steckrichtung	0°
Cable length	10 m
Operating voltage	150 V
Operating current	4 A
Operating current	6 A (0,75 mm ²)
Rated surge voltage	1,2 kV

Mechanical data

Bending cycles	2
Schleppkettentauglichkeit	yes
Durchmesser der Mantelleitung	8.9 ... 9.3 mm
Weight	1200 g

Environmental Requirements

Umgebungstemperatur (Betrieb) bewegt	-30 ... +90 °C
--------------------------------------	----------------



Umgebungstemperatur (Betrieb) ruhend	-40 ... +90 °C
Degree of protection	IP67

Commercial data

Country of origin	DE
GTIN	4044918978514
Customs Tariff No.	85444290900

Downloads

Documentation

System Description

Sensor/Actuator Boxes – General Product Information	Jun 6, 2017	Download
		357.7 kB

Subject to changes.