

Data sheet | Item number: 264-255

4-conductor terminal strip; with snap-in mounting feet; for plate thickness 0.6 - 1.2 mm; Fixing hole 3.5 mm Ø; also fits 210-154 aluminum rail or with 209-123 mounting carrier for DIN 35 rail; 5-pole

www.wago.com/264-255

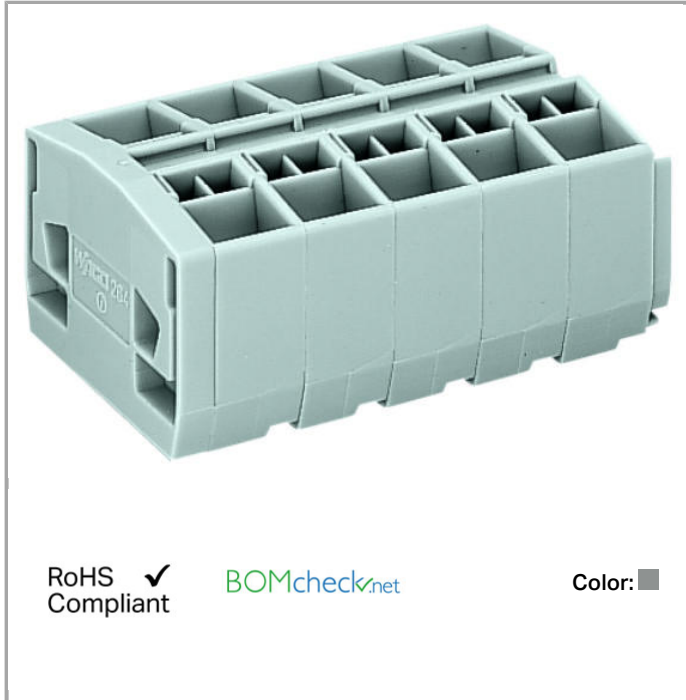

RoHS
Compliant ✓

BOMcheck.net

Color: ■

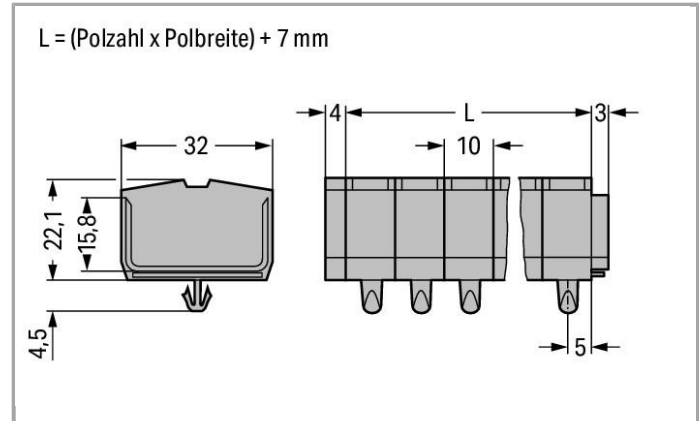

Data

Electrical data

Ratings per IEC/EN 60664-1

| | |
|---------------------------------|---|
| Rated voltage (III / 3) | 800 V |
| Rated impulse voltage (III / 3) | 8 kV |
| Rated current | 24 A |
| Legend (ratings) | (III / 3) ≙ Overvoltage category III / Pollution degree 3 |

Connection data

| | |
|-----------------------------------|--|
| Connection technology | CAGE CLAMP® |
| Actuation type | Operating tool |
| Connectable conductor materials | Copper Aluminum |
| Solid conductor | 0.08 ... 2.5 mm ² / 28 ... 12 AWG |
| Fine-stranded conductor | 0.08 ... 2.5 mm ² / 28 ... 12 AWG |
| Strip length | 8 ... 9 mm / 0.31 ... 0.35 Inch |
| No. of poles | 5 |
| Total number of connection points | 20 |

| | |
|----------------------------|--------------------|
| Total number of potentials | 5 |
| Number of levels | 1 |
| Type of wiring | Front-entry wiring |

Geometrical Data

| | |
|-------------------------|---------------------|
| Width | 57 mm / 2.244 inch |
| Height from the surface | 22.1 mm / 0.87 inch |
| Depth | 32 mm / 1.26 inch |

Mechanical data

| | |
|---------------|-----------------------|
| Design | horizontal |
| Mounting type | Snap-in mounting foot |
| Marking level | Center marking |

Material Data



| | |
|-----------|---------|
| Color | gray |
| Fire load | 0.62 MJ |
| Weight | 33.85 g |

Commercial data

| | |
|--------------------|-----------------------------|
| Country of origin | DE |
| GTIN | 4044918416030 |
| Customs Tariff No. | 85369010000 |
| Product Group | 9 (Std. Chassis Mt. Blocks) |

Approvals / Certificates

Country specific Approvals



| Logo | Approval | Certificate name |
|--|---------------------------------|------------------|
| | CB DEKRA Certification B.V. | NL-49768 |
|  | CCA DEKRA Certification B.V. | NTR NL-7342 |
|  | CCA DEKRA Certification B.V. | NTR NL-7342 |
|  | CCA DEKRA Certification B.V. | 2175624.01 |



CSA
DEKRA Certification B.V.

70010891

Ship Approvals

| Logo | Approval | Certificate name |
|--|---|------------------|
|  | ABS American Bureau of Shipping | 14-HG1241539-PDA |
|  | DNV GL Det Norske Veritas, Germanischer Lloyd | TAE00001V2 |
|  | LR Lloyds Register | 91/20242 (E7) |

UL-Approvals





| Logo | Approval | Certificate name |
|--|---|------------------|
|  | UR Underwriters Laboratories Inc. | E45172, sec. 6 |















Compatible products

General accessories

| | | |
|--|--|--|
|  | Item no.: 209-122 Plastic end stop; for WSB markers; for 210-154 aluminum rail | www.wago.com/209-122 |
|--|--|--|

Marking accessories

| | | |
|--|--|--|
|  | Item no.: 2009-145 Mini-WSB Inline; for smartPRINTER; on reel; stretchable 5 - 5.2 mm; plain; snap-on type | www.wago.com/2009-145 |
|  | Item no.: 2009-145/000-002 Mini-WSB Inline; for smartPRINTER; on reel; stretchable 5 - 5.2 mm; plain; snap-on type | www.wago.com/2009-145/000-002 |
|  | Item no.: 2009-145/000-005 Mini-WSB Inline; for smartPRINTER; on reel; stretchable 5 - 5.2 mm; plain; snap-on type | www.wago.com/2009-145/000-005 |
|  | Item no.: 2009-145/000-006 Mini-WSB Inline; for smartPRINTER; on reel; stretchable 5 - 5.2 mm; plain; snap-on type | www.wago.com/2009-145/000-006 |

| | | |
|--|--|--|
|  | Item no.: 2009-145/000-007 Mini-WSB Inline; for smartPRINTER; on reel; stretchable 5 - 5.2 mm; plain; snap-on type | www.wago.com/2009-145/000-007 |
|  | Item no.: 2009-145/000-012 Mini-WSB Inline; for smartPRINTER; on reel; stretchable 5 - 5.2 mm; plain; snap-on type | www.wago.com/2009-145/000-012 |
|  | Item no.: 2009-145/000-023 Mini-WSB Inline; for smartPRINTER; on reel; stretchable 5 - 5.2 mm; plain; snap-on type | www.wago.com/2009-145/000-023 |
|  | Item no.: 2009-145/000-024 Mini-WSB Inline; on reel; stretchable 5 - 5.2 mm; plain; snap-on type | www.wago.com/2009-145/000-024 |
|  | Item no.: 209-290 Marker tags; not stretchable; plain; snap-on type | www.wago.com/209-290 |
|  | Item no.: 248-501 Miniature WSB Quick marking system; plain; Marker width 5 mm; 10 strips with 10 markers per card | www.wago.com/248-501 |
|  | Item no.: 248-501/000-002 Mini-WSB marking card; as card; not stretchable; plain; snap-on type | www.wago.com/248-501/000-002 |
|  | Item no.: 248-501/000-005 Mini-WSB marking card; as card; plain; snap-on type | www.wago.com/248-501/000-005 |
|  | Item no.: 248-501/000-006 Mini-WSB marking card; as card; not stretchable; plain; snap-on type | www.wago.com/248-501/000-006 |
|  | Item no.: 248-501/000-007 Mini-WSB marking card; as card; not stretchable; plain; snap-on type | www.wago.com/248-501/000-007 |
|  | Item no.: 248-501/000-012 Mini-WSB marking card; as card; not stretchable; plain; snap-on type | www.wago.com/248-501/000-012 |
|  | Item no.: 248-501/000-017 Mini-WSB marking card; as card; not stretchable; plain; snap-on type | www.wago.com/248-501/000-017 |
|  | Item no.: 248-501/000-023 Mini-WSB marking card; as card; not stretchable; plain; snap-on type | www.wago.com/248-501/000-023 |
|  | Item no.: 248-501/000-024 Mini-WSB marking card; as card; not stretchable; plain; snap-on type | www.wago.com/248-501/000-024 |
| Jumper | | |
|  | Item no.: 264-402 Comb-style jumper bar; insulated; 2-way; reduces conductor size to 1.5 mm | www.wago.com/264-402 |



Item no.: 280-492
Alternate comb-style jumper bar; insulated; 2-way; IN = IN terminal block

www.wago.com/280-492

Carrier rail



Item no.: 210-154
Aluminum carrier rail; 1000 mm long; 18 mm wide; 7 mm high

www.wago.com/210-154

assembling



Item no.: 709-153
Cover; Type 1; suitable for cover carrier, type 1; 1 m long

www.wago.com/709-153

check



Item no.: 210-136
Test plug; 2 mm Ø; with 500 mm cable

www.wago.com/210-136



Item no.: 210-137
Test plug; 2.3 mm Ø; with 500 mm cable

www.wago.com/210-137



Item no.: 249-139
Test plug module; without locking device; modular; for 4-conductor terminal blocks

www.wago.com/249-139

ferrule



Item no.: 216-101
Ferrule; Sleeve for 0.5 mm² / AWG 22; uninsulated; electro-tin plated

www.wago.com/216-101



Item no.: 216-102
Ferrule; Sleeve for 0.75 mm² / AWG 20; uninsulated; electro-tin plated

www.wago.com/216-102



Item no.: 216-103
Ferrule; Sleeve for 1 mm² / AWG 18; uninsulated; electro-tin plated

www.wago.com/216-103



Item no.: 216-104
Ferrule; Sleeve for 1.5 mm² / AWG 16; uninsulated; electro-tin plated

www.wago.com/216-104



Item no.: 216-106
Ferrule; Sleeve for 2.5 mm² / AWG 14; uninsulated; electro-tin plated

www.wago.com/216-106



Item no.: 216-121
Ferrule; Sleeve for 0.5 mm² / AWG 22; uninsulated; electro-tin plated

www.wago.com/216-121



Item no.: 216-122
Ferrule; Sleeve for 0.75 mm² / AWG 20; uninsulated; electro-tin plated

www.wago.com/216-122



Item no.: 216-123
Ferrule; Sleeve for 1 mm² / AWG 18; uninsulated; electro-tin plated

www.wago.com/216-123



Item no.: 216-124
Ferrule; Sleeve for 1.5 mm² / AWG 16; uninsulated; electro-tin plated

www.wago.com/216-124















Item no.: 216-131
Ferrule; Sleeve for 0.25 mm² / AWG 24; uninsulated; electro-tin plated

www.wago.com/216-131







Item no.: 216-132
Ferrule; Sleeve for 0.34 mm² / AWG 24; uninsulated; electro-tin plated

www.wago.com/216-132

| | | |
|--|--|--|
|  | Item no.: 216-151 Ferrule; Sleeve for 0.25 mm ² / AWG 24; uninsulated; electro-tin plated | www.wago.com/216-151 |
|  | Item no.: 216-152 Ferrule; Sleeve for 0.34 mm ² / AWG 24; uninsulated; electro-tin plated | www.wago.com/216-152 |
|  | Item no.: 216-201 Ferrule; Sleeve for 0.5 mm ² / AWG 22; insulated; electro-tin plated | www.wago.com/216-201 |
|  | Item no.: 216-202 Ferrule; Sleeve for 0.75 mm ² / AWG 20; insulated; electro-tin plated | www.wago.com/216-202 |
|  | Item no.: 216-203 Ferrule; Sleeve for 1 mm ² / AWG 18; insulated; electro-tin plated | www.wago.com/216-203 |
|  | Item no.: 216-204 Ferrule; Sleeve for 1.5 mm ² / AWG 16; insulated; electro-tin plated | www.wago.com/216-204 |
|  | Item no.: 216-205 Ferrule; Sleeve for 2.08 mm ² / AWG 14; insulated; electro-tin plated | www.wago.com/216-205 |
|  | Item no.: 216-206 Ferrule; Sleeve for 2.5 mm ² / AWG 14; insulated; electro-tin plated | www.wago.com/216-206 |
|  | Item no.: 216-221 Ferrule; Sleeve for 0.5 mm ² / AWG 22; insulated; electro-tin plated | www.wago.com/216-221 |
|  | Item no.: 216-222 Ferrule; Sleeve for 0.75 mm ² / AWG 20; insulated; electro-tin plated | www.wago.com/216-222 |
|  | Item no.: 216-223 Ferrule; Sleeve for 1 mm ² / AWG 18; insulated; electro-tin plated | www.wago.com/216-223 |
|  | Item no.: 216-224 Ferrule; Sleeve for 1.5 mm ² / AWG 16; insulated; electro-tin plated | www.wago.com/216-224 |
|  | Item no.: 216-321 Ferrule; Sleeve for 0.25 mm ² / AWG 24; insulated; electro-tin plated | www.wago.com/216-321 |
|  | Item no.: 216-322 Ferrule; Sleeve for 0.34 mm ² / AWG 24; insulated; electro-tin plated | www.wago.com/216-322 |

tools

| | | |
|--|---|--|
|  | Item no.: 209-130 Operating tool; suitable for 264, 280 and 281 Series; 1-way; of insulating material | www.wago.com/209-130 |
|  | Item no.: 210-657 Operating tool with partially insulated shaft; Blade (3.5 x 0.5) mm; short | www.wago.com/210-657 |
|  | Item no.: 210-658 Operating tool with partially insulated shaft; Blade (3.5 x 0.5) mm; short; angled | www.wago.com/210-658 |
|  | Item no.: 210-720 Operating tool with partially insulated shaft; Type 2, blade (3.5 x 0.5) mm | www.wago.com/210-720 |
|  | Item no.: 280-432 Operating tool; of insulating material; 2-way | www.wago.com/280-432 |



Downloads

Documentation

Bid Text

| | | | |
|---------|--------------|----------------|----------|
| 264-255 | Oct 11, 2017 | DOC 26.1 kB | Download |
|---------|--------------|----------------|----------|

smartDATA

CAD data

| | | |
|---------------------|-----|----------|
| 3D Download 264-255 | URL | Download |
|---------------------|-----|----------|

Subject to changes.