



## Q-tie Cable Tie

### Innovative – Effective – Safe!

The new Q-tie has not only an innovative but also a revolutionary design. The open head of the cable tie enables a simple and quick installation. Just insert the ergonomically bent tail into the open side of the head and tighten the cable tie.

With Q-ties you can save time and money!

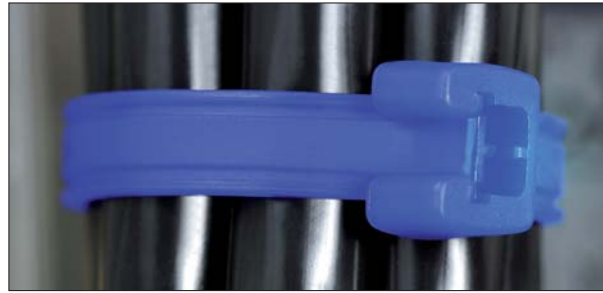

*The head design makes the difference.*

### Easy application for every situation!

Q-tie is the perfect product solution for applications under difficult working conditions. It is designed for use in applications where working with gloves is necessary or for blind applications with a limited view of the work.

The new Q-tie allows a quick and simple installation even with work gloves and restricted view.

Features for quick and easy application:

- Curved and large ribbed tail
- Open head with easy detectable slot

This saves time and trouble!



*Even under difficult circumstances the Q-ties are very fast and easy to apply.*

### Integrated Pre-Locking Functionality!

Due to several simultaneous working processes, it is not always possible to install all cables and conduits in one single step. Thus, working with standard cable ties means either destroying the cable tie of the first installation or applying additional cable ties. The integrated pre-locking function of the Q-tie offers the ability of a temporary and final cable fastening solution.

This saves material and time!



*Without additional effort only Q-ties can be used for temporary and final cable bundling.*

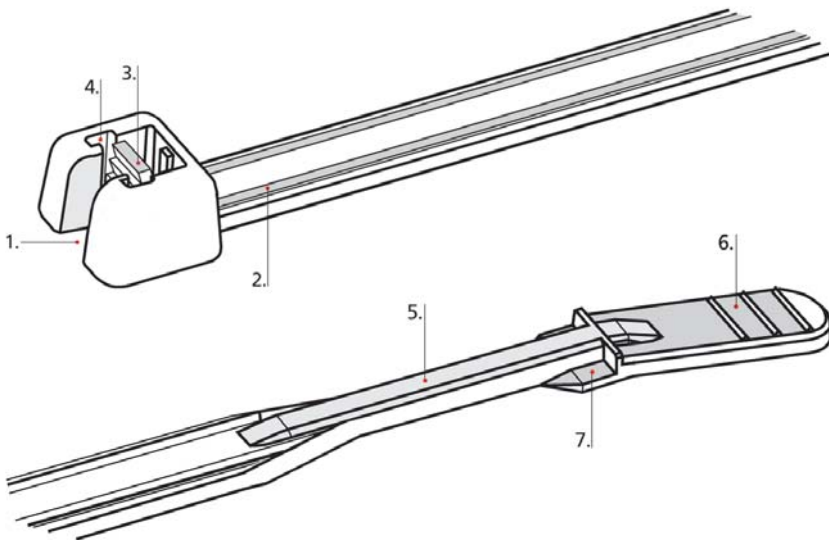

1. Open lock head for quick and easy insertion.
2. Two rails on the strap ensure a perfect guidance for the tracks in the head.
3. The locking device interacts safely with the serration of the cable tie.
4. The tracks prevent a deformation of the head under load.
5. The thin part of the cable tie can be simply placed into the open lock head.
6. The large ribbed tail allows a safe and ergonomic installation.
7. Integrated pre locking feature (starts with type Q30).

### Application Method:



1. Insert the thin part of the cable tie into the open lock head.

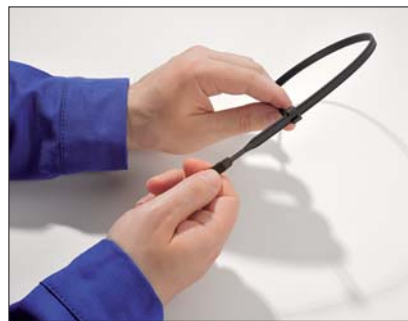

2. Pull the tie through the head until the bundle is fixed.
3. Cut off the remaining part of the tie with an application tool.



Please find more Q-Series products for your system solution on page 166 and 508.

### Pre-locking Function of the Q-tie:



1. Insert tail into lock head and push tail partly in the head.

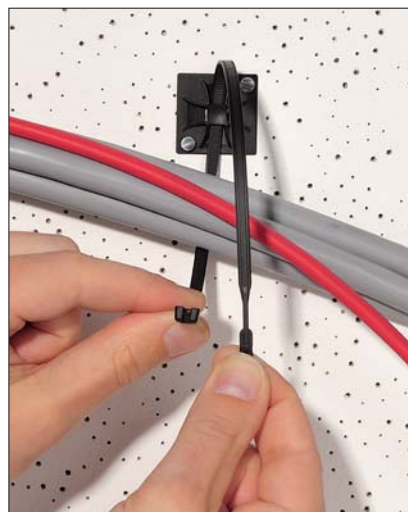

2. To release the tie push tail end slightly out of head.



3. If installation is finished, Q-tie can be tightened and cut off - either manually or with an application tool.



## Cable ties with open head

- Q-ties, Polyamide 6.6 (PA66), natural and black

Application Tool	Registration Numbers
MK3SP	1
MK3PNSP2, MK7P	2
MK7	3
MK7HT	4
MK20	5
MK6	6
MK9P	7
MK9	8
MK9HT	9
MK21	10

For detailed information on Application Tools please refer to page 561.



Q-tie cable ties: choose from a wide product range in different materials.

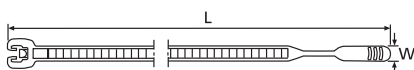

Q-tie cable tie

Material Data	
Material	Polyamide 6.6 (PA66)
Colour	Natural (NA), Black (BK)
Operating Temperature	-40 °C to +85 °C Continuous, (+105 °C for 500 h)
Flammability	UL94 V2



Technical Table

Article-No.	Type	Length (L)	Width (W)	Bundle Ø max.	Min. Tensile Strength (N)	Material	Colour	Application Tool
Polyamide 6.6 (PA66)								
109-00001	Q18R	105	2.6	24.0	80	PA66	Natural (NA)	1-5
109-00004	Q18I	155	2.6	40.0	80	PA66	Natural (NA)	1-5
109-00007	Q18L	195	2.6	50.0	80	PA66	Natural (NA)	1-5
109-00010	Q30R	160	3.6	38.0	130	PA66	Natural (NA)	1-5
109-00012	Q30L	200	3.6	50.0	130	PA66	Natural (NA)	1-5
109-00014	Q30LR	250	3.6	65.0	130	PA66	Natural (NA)	1-5
109-00018	Q50R	210	4.7	50.0	220	PA66	Natural (NA)	1-10
109-00020	Q50I	290	4.7	75.0	220	PA66	Natural (NA)	1-10
109-00022	Q50L	410	4.7	110.0	220	PA66	Natural (NA)	1-10
109-00024	Q120I	300	7.7	70.0	530	PA66	Natural (NA)	6-10
109-00026	Q120R	420	7.7	110.0	530	PA66	Natural (NA)	6-10
109-00028	Q120M	520	7.7	145.0	530	PA66	Natural (NA)	6-10
109-00030	Q18R	105	2.6	24.0	80	PA66	Black (BK)	1-5
109-00033	Q18I	155	2.6	40.0	80	PA66	Black (BK)	1-5
109-00036	Q18L	195	2.6	50.0	80	PA66	Black (BK)	1-5
109-00039	Q30R	160	3.6	38.0	130	PA66	Black (BK)	1-5
109-00041	Q30L	200	3.6	50.0	130	PA66	Black (BK)	1-5
109-00043	Q30LR	250	3.6	65.0	130	PA66	Black (BK)	1-5
109-00047	Q50R	210	4.7	50.0	220	PA66	Black (BK)	1-10
109-00049	Q50I	290	4.7	75.0	220	PA66	Black (BK)	1-10
109-00051	Q50L	410	4.7	110.0	220	PA66	Black (BK)	1-10
109-00053	Q120I	300	7.7	70.0	530	PA66	Black (BK)	6-10
109-00055	Q120R	420	7.7	110.0	530	PA66	Black (BK)	6-10
109-00057	Q120M	520	7.7	145.0	530	PA66	Black (BK)	6-10

All dimensions in mm. Subject to technical changes.



### Cable ties with open head

- Q-ties, Polyamide 6.6 UV-resistant (PA66W), black

Application Tool	Registration Numbers
MK3SP	1
MK3PNSP2, MK7P	2
MK7	3
MK7HT	4
MK20	5
MK6	6
MK9P	7
MK9	8
MK9HT	9
MK21	10

For detailed information on Application Tools please refer to page 561.



Q-tie cable ties: choose from a wide product range in different materials.

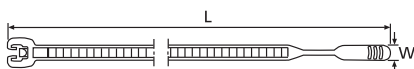

Q-tie cable tie

Material Data	
Material	Polyamide 6.6 UV Resistant (PA66W)
Colour	Black (BK)
Operating Temperature	-40 °C to +85 °C Continuous, (+105 °C for 500 h)
Flammability	UL94 V2



Technical Table

Article-No.	Type	Length (L)	Width (W)	Bundle Ø max.	Min. Tensile Strength (N)	Material	Colour	Application Tool
Polyamide 6.6 UV Stabilised								
109-00059	Q18R	105	2.6	24.0	80	PA66W	Black (BK)	1-5
109-00062	Q18I	155	2.6	40.0	80	PA66W	Black (BK)	1-5
109-00065	Q18L	195	2.6	50.0	80	PA66W	Black (BK)	1-5
109-00068	Q30R	160	3.6	38.0	130	PA66W	Black (BK)	1-5
109-00070	Q30L	200	3.6	50.0	130	PA66W	Black (BK)	1-5
109-00072	Q30LR	250	3.6	65.0	130	PA66W	Black (BK)	1-5
109-00076	Q50R	210	4.7	50.0	220	PA66W	Black (BK)	1-10
109-00078	Q50I	290	4.7	75.0	220	PA66W	Black (BK)	1-10
109-00080	Q50L	410	4.7	110.0	220	PA66W	Black (BK)	1-10
109-00082	Q120I	300	7.7	70.0	530	PA66W	Black (BK)	6-10
109-00084	Q120R	420	7.7	110.0	530	PA66W	Black (BK)	6-10
109-00086	Q120M	520	7.7	145.0	530	PA66W	Black (BK)	6-10

All dimensions in mm. Subject to technical changes.



Please find more Q-Series products for your system solution on page 166 and 508.



## Cable ties with open head

- Q-ties, Polyamide 6.6 heat stabilised (PA66HS), natural and black

Application Tool	Registration Numbers
MK3SP	1
MK3PNSP2, MK7P	2
MK7	3
MK7HT	4
MK20	5
MK6	6
MK9P	7
MK9	8
MK9HT	9
MK21	10

For detailed information on Application Tools please refer to page 561.



Q-tie cable ties: choose from a wide product range in different materials.

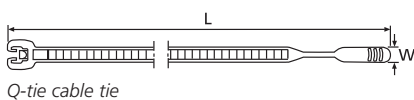

Q-tie cable tie

Material Data	
Material	Polyamide 6.6 Heat Stabilised (PA66HS)
Colour	Natural (NA), Black (BK)
Operating Temperature	-40 °C to +105 °C Continuous, (+145 °C for 500 h)
Flammability	UL94 V2



Technical Table

Article-No.	Type	Length (L)	Width (W)	Bundle Ø max.	Min. Tensile Strength (N)	Material	Colour	Application Tool
Polyamide 6.6 Heat Stabilised								
109-00088	Q18R	105	2.6	24.0	80	PA66HS	Black (BK)	1-5
109-00091	Q18I	155	2.6	40.0	80	PA66HS	Black (BK)	1-5
109-00094	Q18L	195	2.6	50.0	80	PA66HS	Black (BK)	1-5
109-00097	Q30R	160	3.6	38.0	130	PA66HS	Black (BK)	1-5
109-00099	Q30L	200	3.6	50.0	130	PA66HS	Black (BK)	1-5
109-00101	Q30LR	250	3.6	65.0	130	PA66HS	Black (BK)	1-5
109-00105	Q50R	210	4.7	50.0	220	PA66HS	Black (BK)	1-10
109-00107	Q50I	290	4.7	75.0	220	PA66HS	Black (BK)	1-10
109-00109	Q50L	410	4.7	110.0	220	PA66HS	Black (BK)	1-10
109-00111	Q120I	300	7.7	70.0	530	PA66HS	Black (BK)	6-10
109-00113	Q120R	420	7.7	110.0	530	PA66HS	Black (BK)	6-10
109-00115	Q120M	520	7.7	145.0	530	PA66HS	Black (BK)	6-10
109-00117	Q18R	105	2.6	24.0	80	PA66HS	Natural (NA)	1-5
109-00120	Q18I	155	2.6	40.0	80	PA66HS	Natural (NA)	1-5
109-00123	Q18L	195	2.6	50.0	80	PA66HS	Natural (NA)	1-5
109-00126	Q30R	160	3.6	38.0	130	PA66HS	Natural (NA)	1-5
109-00128	Q30L	200	3.6	50.0	130	PA66HS	Natural (NA)	1-5
109-00130	Q30LR	250	3.6	65.0	130	PA66HS	Natural (NA)	1-5
109-00134	Q50R	210	4.7	50.0	220	PA66HS	Natural (NA)	1-10
109-00136	Q50I	290	4.7	75.0	220	PA66HS	Natural (NA)	1-10
109-00138	Q50L	410	4.7	110.0	220	PA66HS	Natural (NA)	1-10
109-00140	Q120I	300	7.7	70.0	530	PA66HS	Natural (NA)	6-10
109-00142	Q120R	420	7.7	110.0	530	PA66HS	Natural (NA)	6-10
109-00144	Q120M	520	7.7	145.0	530	PA66HS	Natural (NA)	6-10

All dimensions in mm. Subject to technical changes.



### Cable ties with open head

- Q-ties, Polyamide 6.6 (PA66), coloured

Application Tool	Registration Numbers
MK3SP	1
MK3PNSP2, MK7P	2
MK7	3
MK7HT	4
MK20	5
MK6	6
MK9P	7
MK9	8
MK9HT	9
MK21	10

For detailed information on Application Tools please refer to page 561.

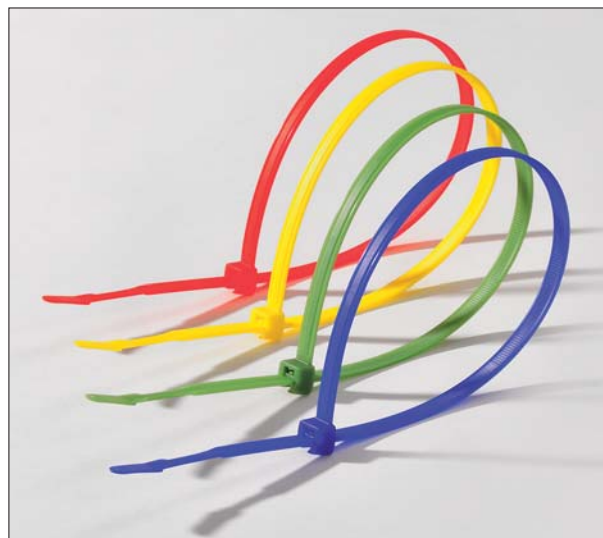

Q-ties in different colours are ideal for marking and bundling in one step.

Please find more Q-Series products for your system solution on page 166 and 508.

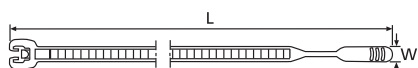

Q-tie cable tie

Material Data	
Material	Polyamide 6.6 (PA66)
Colour	Brown (BN), Blue (BU), Green (GN), Red (RD), Yellow (YE)
Operating Temperature	-40 °C to +85 °C Continuous, (+105 °C for 500 h)
Flammability	UL94 V2



Technical Table

Article-No.	Type	Length (L)	Width (W)	Bundle Ø max.	Min. Tensile Strength (N)	Material	Colour	Application Tool
Polyamide 6.6 Colours								
109-00146	Q18R	105	2.6	24.0	80	PA66	Brown (BN)	1-5
109-00147	Q18R	105	2.6	24.0	80	PA66	Blue (BU)	1-5
109-00148	Q18R	105	2.6	24.0	80	PA66	Green (GN)	1-5
109-00149	Q18R	105	2.6	24.0	80	PA66	Red (RD)	1-5
109-00150	Q18R	105	2.6	24.0	80	PA66	Yellow (YE)	1-5
109-00151	Q18I	155	2.6	40.0	80	PA66	Brown (BN)	1-5
109-00152	Q18I	155	2.6	40.0	80	PA66	Blue (BU)	1-5
109-00153	Q18I	155	2.6	40.0	80	PA66	Green (GN)	1-5
109-00154	Q18I	155	2.6	40.0	80	PA66	Red (RD)	1-5
109-00155	Q18I	155	2.6	40.0	80	PA66	Yellow (YE)	1-5
109-00156	Q18L	195	2.6	50.0	80	PA66	Brown (BN)	1-5
109-00157	Q18L	195	2.6	50.0	80	PA66	Blue (BU)	1-5
109-00158	Q18L	195	2.6	50.0	80	PA66	Green (GN)	1-5
109-00159	Q18L	195	2.6	50.0	80	PA66	Red (RD)	1-5
109-00160	Q18L	195	2.6	50.0	80	PA66	Yellow (YE)	1-5
109-00161	Q30R	160	3.6	38.0	130	PA66	Brown (BN)	1-5
109-00162	Q30R	160	3.6	38.0	130	PA66	Blue (BU)	1-5
109-00163	Q30R	160	3.6	38.0	130	PA66	Green (GN)	1-5
109-00164	Q30R	160	3.6	38.0	130	PA66	Red (RD)	1-5
109-00165	Q30R	160	3.6	38.0	130	PA66	Yellow (YE)	1-5
109-00166	Q30L	200	3.6	50.0	130	PA66	Brown (BN)	1-5
109-00167	Q30L	200	3.6	50.0	130	PA66	Blue (BU)	1-5
109-00168	Q30L	200	3.6	50.0	130	PA66	Green (GN)	1-5
109-00169	Q30L	200	3.6	50.0	130	PA66	Red (RD)	1-5
109-00170	Q30L	200	3.6	50.0	130	PA66	Yellow (YE)	1-5

All dimensions in mm. Subject to technical changes.



## Cable ties with open head

- Q-ties, Polyamide 6.6 (PA66), coloured

Application Tool	Registration Numbers
MK3SP	1
MK3PNSP2, MK7P	2
MK7	3
MK7HT	4
MK20	5
MK6	6
MK9P	7
MK9	8
MK9HT	9
MK21	10

For detailed information on Application Tools please refer to page 561.

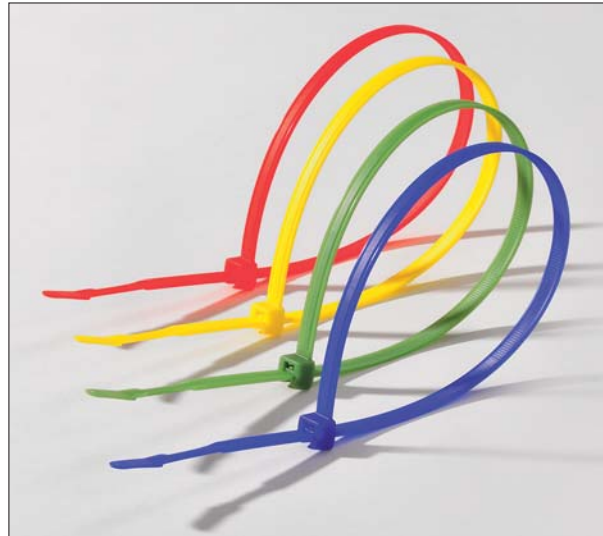

Q-ties in different colours are ideal for marking and bundling in one step.

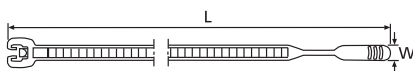

Q-tie cable tie

Material Data	
Material	Polyamide 6.6 (PA66)
Colour	Brown (BN), Blue (BU), Green (GN), Red (RD), Yellow (YE)
Operating Temperature	-40 °C to +85 °C Continuous, (+105 °C for 500 h)
Flammability	UL94 V2



Technical Table

Article-No.	Type	Length (L)	Width (W)	Bundle Ø max.	Min. Tensile Strength (N)	Material	Colour	Application Tool
Polyamide 6.6 Colours								
109-00171	Q30LR	250	3.6	65.0	130	PA66	Brown (BN)	1-5
109-00172	Q30LR	250	3.6	65.0	130	PA66	Blue (BU)	1-5
109-00173	Q30LR	250	3.6	65.0	130	PA66	Green (GN)	1-5
109-00174	Q30LR	250	3.6	65.0	130	PA66	Red (RD)	1-5
109-00175	Q30LR	250	3.6	65.0	130	PA66	Yellow (YE)	1-5
109-00181	Q50R	210	4.7	50.0	220	PA66	Brown (BN)	1-10
109-00182	Q50R	210	4.7	50.0	220	PA66	Blue (BU)	1-10
109-00183	Q50R	210	4.7	50.0	220	PA66	Green (GN)	1-10
109-00184	Q50R	210	4.7	50.0	220	PA66	Red (RD)	1-10
109-00185	Q50R	210	4.7	50.0	220	PA66	Yellow (YE)	1-10
109-00186	Q50I	290	4.7	75.0	220	PA66	Brown (BN)	1-10
109-00187	Q50I	290	4.7	75.0	220	PA66	Blue (BU)	1-10
109-00188	Q50I	290	4.7	75.0	220	PA66	Green (GN)	1-10
109-00189	Q50I	290	4.7	75.0	220	PA66	Red (RD)	1-10
109-00190	Q50I	290	4.7	75.0	220	PA66	Yellow (YE)	1-10
109-00191	Q50L	410	4.7	110.0	220	PA66	Brown (BN)	1-10
109-00192	Q50L	410	4.7	110.0	220	PA66	Blue (BU)	1-10
109-00193	Q50L	410	4.7	110.0	220	PA66	Green (GN)	1-10
109-00194	Q50L	410	4.7	110.0	220	PA66	Red (RD)	1-10
109-00195	Q50L	410	4.7	110.0	220	PA66	Yellow (YE)	1-10

All dimensions in mm. Subject to technical changes.



### Cable ties with open head

- Q-ties, Polyamide 6.6 (PA66), coloured

Application Tool	Registration Numbers
MK3SP	1
MK3PNSP2, MK7P	2
MK7	3
MK7HT	4
MK20	5
MK6	6
MK9P	7
MK9	8
MK9HT	9
MK21	10

For detailed information on Application Tools please refer to page 561.

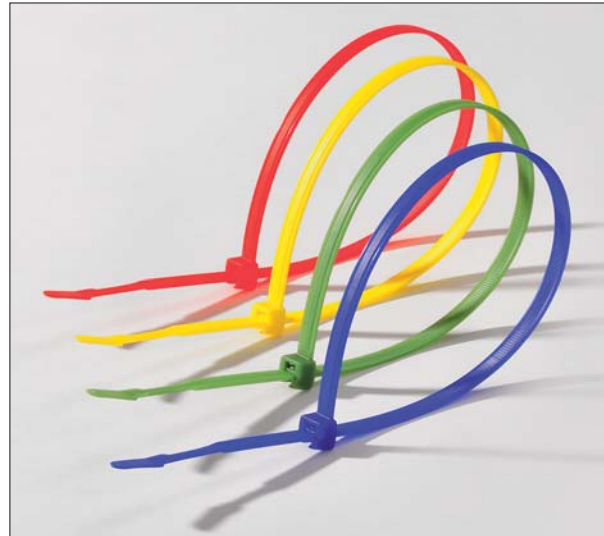

Q-ties in different colours are ideal for marking and bundling in one step.

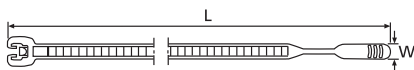

Q-tie cable tie

#### Material Data

Material	<b>Polyamide 6.6 (PA66)</b>
Colour	<b>Brown (BN), Blue (BU), Green (GN), Red (RD), Yellow (YE)</b>
Operating Temperature	<b>-40 °C to +85 °C Continuous, (+105 °C for 500 h)</b>
Flammability	<b>UL94 V2</b>



#### Technical Table

Article-No.	Type	Length (L)	Width (W)	Bundle Ø max.	Min. Tensile Strength (N)	Material	Colour	Application Tool
Polyamide 6.6 Colours								
109-00196	Q120I	300	7.7	70.0	530	PA66	Brown (BN)	6-10
109-00197	Q120I	300	7.7	70.0	530	PA66	Blue (BU)	6-10
109-00198	Q120I	300	7.7	70.0	530	PA66	Green (GN)	6-10
109-00199	Q120I	300	7.7	70.0	530	PA66	Red (RD)	6-10
109-00200	Q120I	300	7.7	70.0	530	PA66	Yellow (YE)	6-10
109-00201	Q120R	420	7.7	110.0	530	PA66	Brown (BN)	6-10
109-00202	Q120R	420	7.7	110.0	530	PA66	Blue (BU)	6-10
109-00203	Q120R	420	7.7	110.0	530	PA66	Green (GN)	6-10
109-00204	Q120R	420	7.7	110.0	530	PA66	Red (RD)	6-10
109-00205	Q120R	420	7.7	110.0	530	PA66	Yellow (YE)	6-10
109-00206	Q120M	520	7.7	145.0	530	PA66	Brown (BN)	6-10
109-00207	Q120M	520	7.7	145.0	530	PA66	Blue (BU)	6-10
109-00208	Q120M	520	7.7	145.0	530	PA66	Green (GN)	6-10
109-00209	Q120M	520	7.7	145.0	530	PA66	Red (RD)	6-10
109-00210	Q120M	520	7.7	145.0	530	PA66	Yellow (YE)	6-10

All dimensions in mm. Subject to technical changes.



Please find more Q-Series products for your system solution on page 166 and 508.