

Multi-Range DC Power Supply

PSW Series

USER MANUAL

GW INSTEK PART NO. 825W-80400ME1



ISO-9001 CERTIFIED MANUFACTURER

GW INSTEK

This manual contains proprietary information, which is protected by copyright. All rights are reserved. No part of this manual may be photocopied, reproduced or translated to another language without prior written consent of Good Will company.

The information in this manual was correct at the time of printing. However, Good Will continues to improve products and reserves the rights to change specification, equipment, and maintenance procedures at any time without notice.

Good Will Instrument Co., Ltd.
No. 7-1, Jhongsing Rd., Tucheng Dist., New Taipei City 236, Taiwan.

Table of Contents

| | |
|--------------------------------------|------------|
| SAFETY INSTRUCTIONS | 5 |
| GETTING STARTED | 9 |
| PSW Series Overview | 10 |
| Appearance | 15 |
| Theory of Operation | 21 |
| OPERATION | 33 |
| Set Up | 35 |
| Basic Operation | 49 |
| Parallel / Series Operation | 62 |
| Test Scripts | 76 |
| CONFIGURATION | 84 |
| Configuration | 85 |
| ANALOG CONTROL | 101 |
| Analog Remote Control Overview | 102 |
| Remote Monitoring | 118 |
| COMMUNICATION INTERFACE | 123 |
| Interface Configuration | 124 |
| MAINTENANCE | 135 |
| FAQ | 137 |
| APPENDIX | 139 |
| Firmware Update | 139 |
| PSW Default Settings | 143 |
| Error Messages & Messages | 145 |

| | |
|---------------------------------|------------|
| LCD Display Format | 145 |
| PSW Specifications | 146 |
| PSW Dimensions | 155 |
| Declaration of Conformity | 158 |
| INDEX..... | 159 |

S SAFETY INSTRUCTIONS

This chapter contains important safety instructions that you must follow during operation and storage. Read the following before any operation to insure your safety and to keep the instrument in the best possible condition.

Safety Symbols

These safety symbols may appear in this manual or on the instrument.



WARNING

Warning: Identifies conditions or practices that could result in injury or loss of life.



CAUTION

Caution: Identifies conditions or practices that could result in damage to the PSW or to other properties.



DANGER High Voltage



Attention Refer to the Manual



Protective Conductor Terminal



Earth (ground) Terminal



Do not dispose electronic equipment as unsorted municipal waste. Please use a separate collection facility or contact the supplier from which this instrument was purchased.

Safety Guidelines

General Guideline



CAUTION

- Do not place any heavy object on the PSW.
- Avoid severe impact or rough handling that leads to damaging the PSW.
- Do not discharge static electricity to the PSW.
- Use only mating connectors, not bare wires, for the terminals.
- Do not block the cooling fan opening.
- Do not disassemble the PSW unless you are qualified.

(Measurement categories) EN 61010-1:2001 specifies the measurement categories and their requirements as follows. the PSW falls under category II.

- Measurement category IV is for measurement performed at the source of low-voltage installation.
- Measurement category III is for measurement performed in the building installation.
- Measurement category II is for measurement performed on the circuits directly connected to the low voltage installation.
- Measurement category I is for measurements performed on circuits not directly connected to Mains.

Power Supply



WARNING

- AC Input voltage range: 85VAC~265VAC
 - Frequency: 47Hz~63Hz
 - To avoid electrical shock connect the protective grounding conductor of the AC power cord to an earth ground.
-

-
- Cleaning the PSW
- Disconnect the power cord before cleaning.
 - Use a soft cloth dampened in a solution of mild detergent and water. Do not spray any liquid.
 - Do not use chemicals containing harsh material such as benzene, toluene, xylene, and acetone.
-

Operation
Environment

- Location: Indoor, no direct sunlight, dust free, almost non-conductive pollution (Note below)
- Relative Humidity: 20%~ 85%
- Altitude: < 2000m
- Temperature: 0°C to 50°C

(Pollution Degree) EN 61010-1:2001 specifies the pollution degrees and their requirements as follows. The PSW falls under degree 2.

Pollution refers to “addition of foreign matter, solid, liquid, or gaseous (ionized gases), that may produce a reduction of dielectric strength or surface resistivity”.

- Pollution degree 1: No pollution or only dry, non-conductive pollution occurs. The pollution has no influence.
 - Pollution degree 2: Normally only non-conductive pollution occurs. Occasionally, however, a temporary conductivity caused by condensation must be expected.
 - Pollution degree 3: Conductive pollution occurs, or dry, non-conductive pollution occurs which becomes conductive due to condensation which is expected. In such conditions, equipment is normally protected against exposure to direct sunlight, precipitation, and full wind pressure, but neither temperature nor humidity is controlled.
-

Storage
environment

- Location: Indoor
 - Temperature: -25°C to 70°C
 - Relative Humidity: <90%
-

Disposal



Do not dispose this instrument as unsorted municipal waste. Please use a separate collection facility or contact the supplier from which this instrument was purchased. Please make sure discarded electrical waste is properly recycled to reduce environmental impact.

Power cord for the United Kingdom

When using the power supply in the United Kingdom, make sure the power cord meets the following safety instructions.

NOTE: This lead/appliance must only be wired by competent persons



WARNING: THIS APPLIANCE MUST BE EARTHED

IMPORTANT: The wires in this lead are coloured in accordance with the following code:

| | |
|----------------|--------------|
| Green/ Yellow: | Earth |
| Blue: | Neutral |
| Brown: | Live (Phase) |



As the colours of the wires in main leads may not correspond with the coloured marking identified in your plug/appliance, proceed as follows:

The wire which is coloured Green & Yellow must be connected to the Earth terminal marked with either the letter E, the earth symbol \oplus or coloured Green/Green & Yellow.

The wire which is coloured Blue must be connected to the terminal which is marked with the letter N or coloured Blue or Black.

The wire which is coloured Brown must be connected to the terminal marked with the letter L or P or coloured Brown or Red.

If in doubt, consult the instructions provided with the equipment or contact the supplier.

This cable/appliance should be protected by a suitably rated and approved HBC mains fuse: refer to the rating information on the equipment and/or user instructions for details. As a guide, a cable of 0.75mm² should be protected by a 3A or 5A fuse. Larger conductors would normally require 13A types, depending on the connection method used.

Any exposed wiring from a cable, plug or connection that is engaged in a live socket is extremely hazardous. If a cable or plug is deemed hazardous, turn off the mains power and remove the cable, any fuses and fuse assemblies. All hazardous wiring must be immediately destroyed and replaced in accordance to the above standard.

G E T T I N G S T A R T E D

This chapter describes the power supply in a nutshell, including its main features and front / rear panel introduction. After going through the overview, please read the theory of operation to become familiar with the operating modes, protection modes and other safety considerations.



| | |
|----------------------------------|-----------|
| PSW Series Overview | 10 |
| Series lineup..... | 10 |
| Main Features..... | 11 |
| Accessories..... | 12 |
| Package Contents..... | 14 |
| Appearance | 15 |
| PSW Front Panel | 15 |
| Rear Panel | 18 |

PSW Series Overview

Series lineup

The PSW series consists of 9 models, divided into 3 different model types covering 3 power capacities: Type I (360 Watt), Type II (720 Watt) and Type III (1080 Watt).

| Model name | Type | Voltage Rating | Current Rating | Power |
|--------------|----------|----------------|----------------|-------|
| PSW 30-36 | Type I | 0~30V | 0~36A | 360W |
| PSW 80-13.5 | Type I | 0~80V | 0~13.5A | 360W |
| PSW 160-7.2 | Type I | 0~160V | 0~7.2A | 360W |
| PSW 30-72 | Type II | 0~30V | 0~72A | 720W |
| PSW 80-27 | Type II | 0~80V | 0~27A | 720W |
| PSW 160-14.4 | Type II | 0~160V | 0~14.4A | 720W |
| PSW 30-108 | Type III | 0~30V | 0~108A | 1080W |
| PSW 80-40.5 | Type III | 0~80V | 0~40.5A | 1080W |
| PSW 160-21.6 | Type III | 0~160V | 0~21.6A | 1080W |

Apart from the differences in output, each unit differs in size. The 720 and 1080 watt models are larger than the 360 watt models to accommodate the increase in power.

360 Watt models

Type I

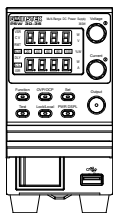

720 Watt models

Type II

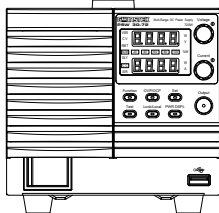

1080 Watt models

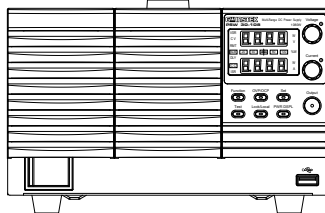

Type III



Main Features

- | | |
|-------------|--|
| Performance | <ul style="list-style-type: none">• High performance/power• Power efficient switching type power supply• Low impact on load devices• Fast transient recovery time of 1ms• Fast output response time <hr/> |
| Features | <ul style="list-style-type: none">• OVP, OCP and OTP protection• Adjustable voltage and current slew rates• User adjustable bleeder control to quickly dissipate the power after shutdown to safe levels.• Extensive remote monitoring and control options• Support for serial and parallel connections• Power on configuration settings.• Supports test scripts• Web server monitoring and control <hr/> |
| Interface | <ul style="list-style-type: none">• Ethernet port• Analog connector for analog voltage and current monitoring• USB host and device port |

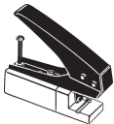
Accessories

| Standard Accessories | Part number | Description |
|----------------------|------------------|--|
| | Region dependant | User manual |
| | 4323-30600101 | Power cord (Type I/II) |
| | 4320-91001101 | Power cord (Type III) |
| | 63SC-XF100201 | Output terminal cover: top |
| | 63SC-XF100301 | Output terminal cover: bottom |
| | GTL-123 | Test leads: 1x red, 1x black |
| | GTL-240 | USB Cable |
| | PSW-004 | Basic Accessory Kit: M4 terminal screws and washers x2, M8 terminal bolts, nuts and washers x2, Air filter x1, Analog control protection dummy x1, Analog control lock level x1 |
| Optional Accessories | Part number | Description |
| | GET-001 | Extended terminal |
| | PSW-001 | Accessory Kit: Pin contact x10, Socket x1, Protection cover x1 |
| | PSW-002 | Simple IDC Tool  |
| | PSW-003 | Contact Removal Tool  |

| | | |
|----------|---------------|---------------------------------------|
| | PSW-005 | Series operation cable for 2 units. |
| | PSW-006 | Parallel operation cable for 2 units. |
| | PSW-007 | Parallel operation cable for 3 units. |
| | GRA-410-J | Rack mount adapter (JIS) |
| | GRA-410-E | Rack mount adapter (EIA) |
| | GUG-001 | GPIB to USB adapter |
| | GTL-240 | USB Cable |
| | 57RG-30B00201 | Large filter (Type II/III) |
| Download | Name | Description |
| | psw_cdc.inf | USB driver |

Package Contents

Check the contents before using the PSW.

Opening the box

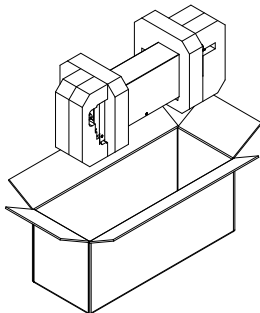

Contents (single unit)

- Main unit
- Output terminal cover (top x1, bottom x1)
- Test leads (red x1, black x1)
- M4 terminal screws and washers x2
- Air filter x1
- L-type USB cable x1
- Power cord x1 (region dependent)
- Analog control protection dummy x1
- Analog control lock lever x1
- M8 terminal bolts, nuts and washers X2

Appearance

PSW Front Panel

PSW 160-14.4, PSW 80-27, PSW 30-72 (720W)

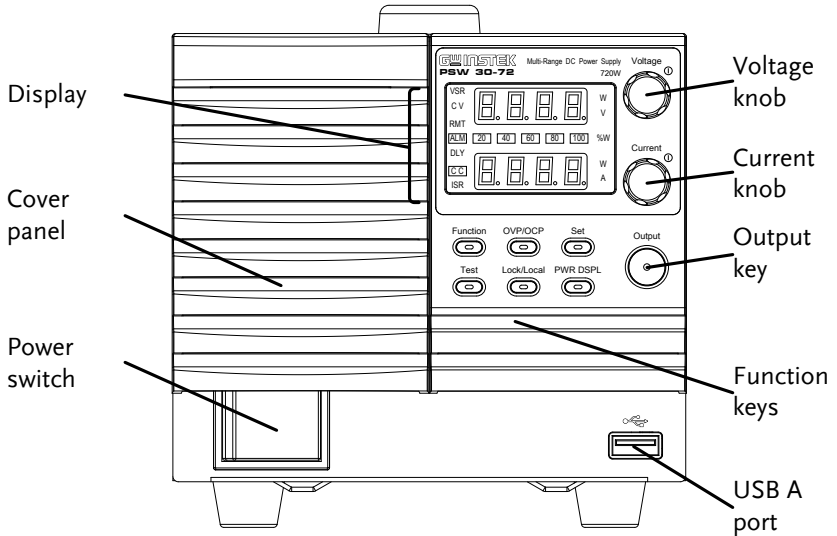

PSW 160-21.6, PSW 80-40.5, PSW 30-108
(1080W)

PSW 160-7.2,
PSW 80-13.5,
PSW 30-36 (360W)

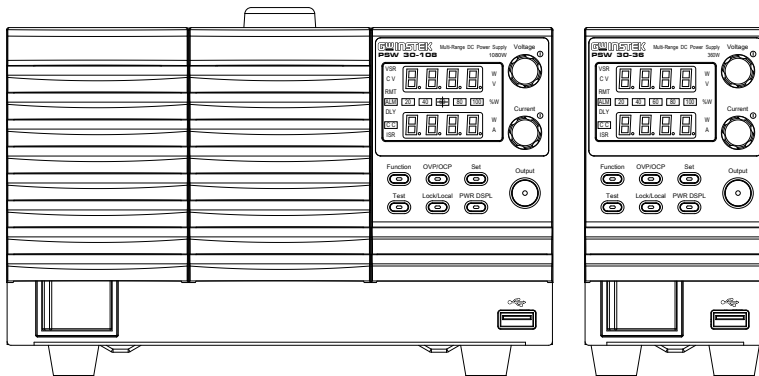

Function Keys The Function keys along with the Output key will light up when a key is active.

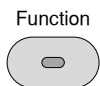

The Function key is used to configure the power supply.



Set the over current or over voltage protection levels.

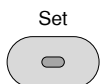

Sets the current and voltage limits.

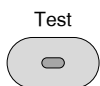

Used to run customized scripts for testing.



Locks or unlocks the panel keys to prevent accidentally changing panel settings.



Toggles the display from viewing V/A → V/W → A/W.

Display Indicators

- VSR** Voltage Slew Rate
- C V** Constant Voltage Mode
- RMT** Remote Control Mode
- ALM** Alarm on
- DLY** Delay Output
- CC** Constant Current Mode
- ISR** Current Slew Rate



Power bar
Indicates the current power output as a percentage.

Voltage Knob

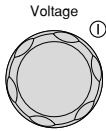

Sets the voltage.

Current Knob

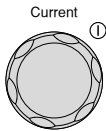

Sets the current.

Output

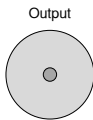

Press to turn on the output. The Output key will light up when the output is active.

USB

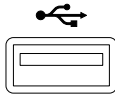

USB A port for data transfer, loading test scripts etc.

Power Switch

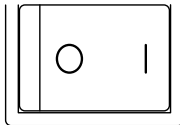

Used to turn the power on/off.

Rear Panel

PSW 160-14.4, PSW 80-27, PSW 30-72 (720W)

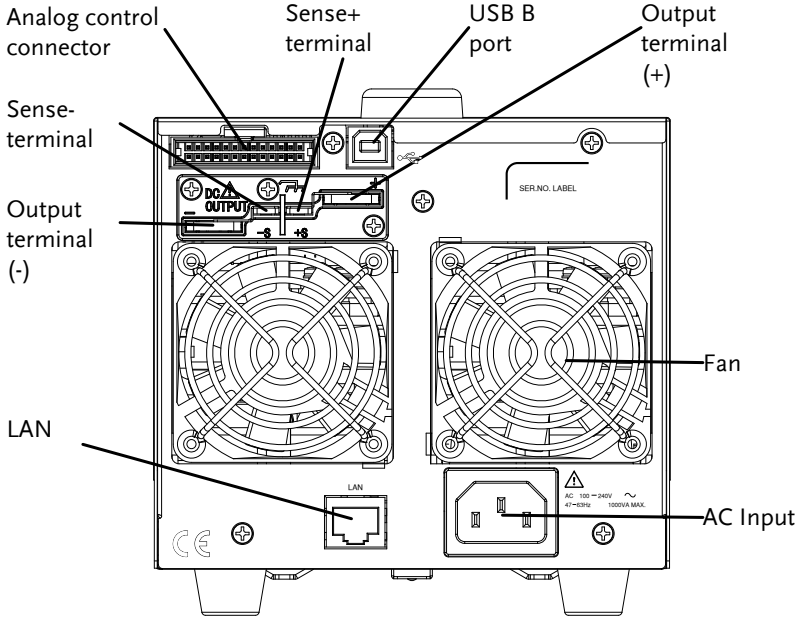

PSW 160-21.6, PSW 80-40.5, PSW 30-108 (1080W)

PSW 160-7.2,
PSW 80-13.5,
PSW 30-36 (360W)

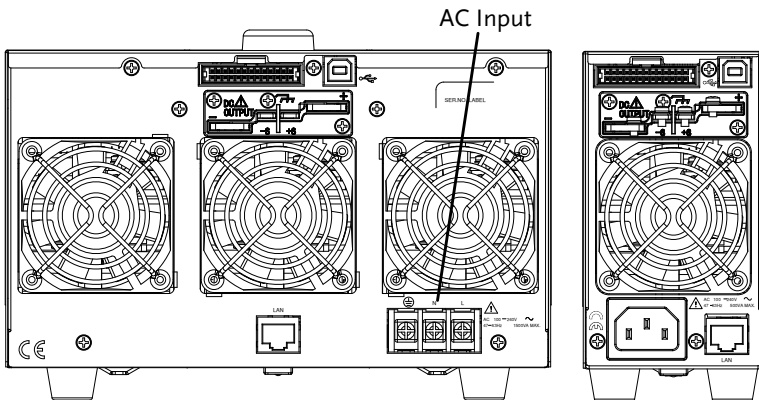

Analog Control Connector



Standard 26 pin MIL connector (OMRON XG4 IDC plug).

The analog control connector is used to monitor current and voltage output, machine status (OVP, OCP, OTP etc.), and for analog control of the current and voltage output.

Use an OMRON XG5 IDC socket as the mating socket.

Output Terminals

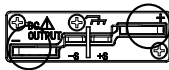

Positive (+) and negative (-) output terminals.

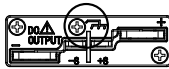

Chassis ground



Sense (-) and Sense (+) terminals.

USB B port

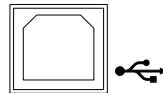

The USB B port is used for remote control.

Fans

Temperature controlled fans

Ethernet Port

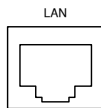

The ethernet port is used for remote control and digital monitoring from a PC.

Line Voltage Input
(Type I/TypeII)

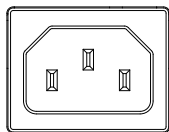

Type I: PSW 30-36/80-13.5/160-7.2
 Type II: PSW 30-72/80-27/160-14.4

- Voltage Input: 100~240 VAC
- Line frequency: 50Hz/60 Hz (Automatically switchable)

Line Voltage
Input
(Type III)

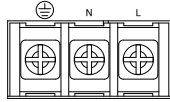

Type III:

PSW 30-108/80-40.5/160-21.6

- Voltage Input: 100~240 VAC
- Line frequency: 50Hz/60 Hz
(Automatically switchable)

Theory of Operation

The theory of operation chapter describes the basic principles of operation, protection modes and important considerations that must be taken into account before use.

Operating Area Description

Background

The PSW power supplies are regulated DC power supplies with a high voltage and current output. These operate in CC or CV mode within a wide operating range limited only by the output power.

The operating area of each power supply is determined by the rated output power as well as the voltage and current rating. For example the operating area and rated power output for the PSW 30-36 is shown below.

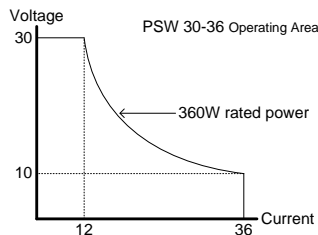

When the power supply is configured so that the total output (current x voltage output) is less than the rated power output, the power supply functions as a typical constant current, constant voltage power supply.

If however, the power supply is configured such that the total output (current x voltage output) exceeds the rated power output, the

effective output is actually limited to the power limit of the unit. In this case the output current and voltage then depend purely on the load value.

Below is a comparison of the operating areas of each power supply.

PSW 160V Series Operating Area

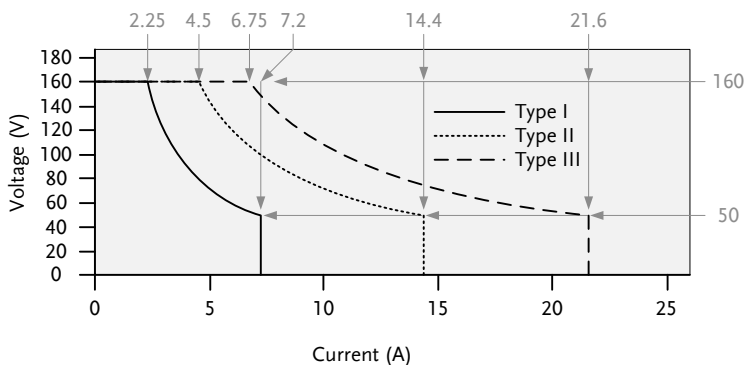

PSW 80V Series Operating Area

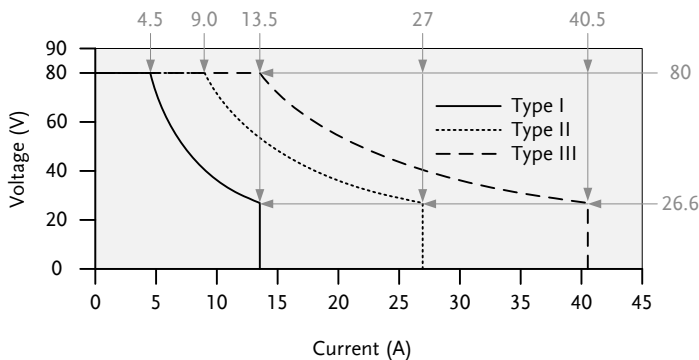

PSW 30V Series Operating Area

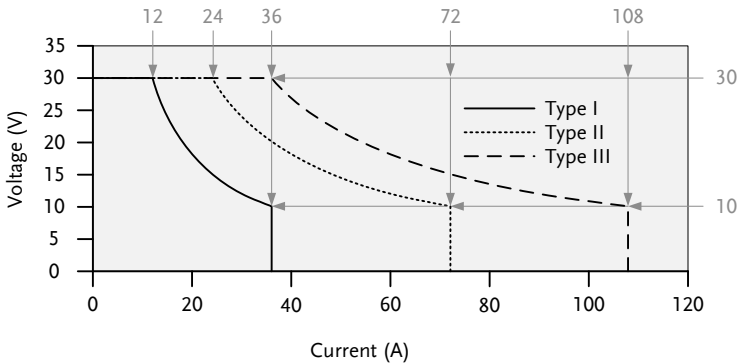

CC and CV Mode

CC and CV mode
Description

When the power supply is operating in constant current mode (CC) a constant current will be supplied to the load. When in constant current mode the voltage output can vary, whilst the current remains constant. When the load resistance increases to the point where the current limit (I_{SET}) can no longer be sustained the power supply switches to CV mode. The point where the power supply switches modes is the crossover point.

When the power supply is operating in CV mode, a constant voltage will be supplied to the load, whilst the current will vary as the load varies. At the point that the load resistance is too low to maintain a constant voltage, the power supply will switch to CC mode and maintain the set current limit.

The conditions that determine whether the power supply operates in CC or CV mode depends on the set current (I_{SET}), the set voltage

(V_{SET}), the load resistance (R_L) and the critical resistance (R_C). The critical resistance is determined by V_{SET}/I_{SET} . The power supply will operate in CV mode when the load resistance is greater than the critical resistance. This means that the voltage output will be equal to the V_{SET} voltage but the current will be less than I_{SET} . If the load resistance is reduced to the point that the current output reaches the I_{SET} level, the power supply switches to CC mode.

Conversely the power supply will operate in CC mode when the load resistance is less than the critical resistance. In CC mode the current output is equal to I_{SET} and the voltage output is less than V_{SET} .

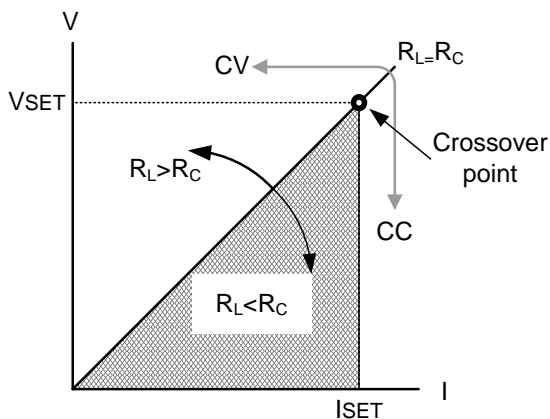

Slew Rate

Theory

The PSW has selectable slew rates for CC and CV mode. This gives the PSW power supply the ability to limit the current/voltage draw of the power supply. Slew rate settings are divided into High Speed Priority and Slew Rate Priority. High Speed Priority mode disables slew rate settings for CC or CV mode. Slew Rate Priority mode allows for user adjustable slew rates for CC or CV mode. The rising and falling slew rate can be set independently.

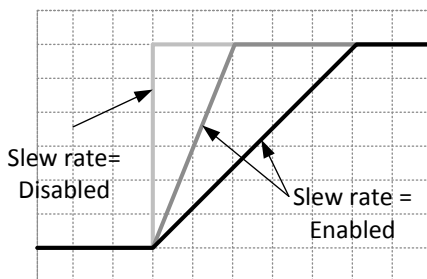

Bleeder Control

Background

The PSW DC power supplies employ a bleed resistor in parallel with the output terminals.

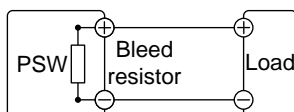

Bleed resistors are designed to dissipate the power from the power supply filter capacitors when power is turned off and the load is disconnected. Without a bleed resistor, power

may remain charged on the filter capacitors for some time and be potentially hazardous.

In addition, bleed resistors also allow for smoother voltage regulation of the power supply as the bleed resistor acts as a minimum voltage load.

The bleed resistance can be turned on or off using the configuration settings.



Note

By default the bleed resistance is on. For battery charging applications, be sure to turn the bleed resistance off as the bleed resistor can discharge the connected battery when the unit is off.

Internal Resistance

Background

On the PSW, the internal resistance of the power supply can be user-defined in software. (Internal Resistance Setting, page 89). When the internal resistance is set it can be seen as a resistance in series with the positive output terminal. This allows the power supply to simulate power sources that have internal resistances such as lead acid batteries.

Internal Resistance Range

| Unit Model | Internal Resistance Range |
|--------------|---------------------------|
| PSW 30-36 | 0.000 ~ 0.833Ω |
| PSW 30-72 | 0.000 ~ 0.417Ω |
| PSW 30-108 | 0.000 ~ 0.278Ω |
| PSW 80-13.5 | 0.000 ~ 5.926Ω |
| PSW 80-27 | 0.000 ~ 2.963Ω |
| PSW 80-40.5 | 0.000 ~ 1.975Ω |
| PSW 160-7.2 | 0.000 ~ 22.222Ω |
| PSW 160-14.4 | 0.000 ~ 11.111Ω |
| PSW 160-21.6 | 0.000 ~ 7.407Ω |

Alarms

The PSW power supplies have a number of protection features. When one of the protection alarms are set, the ALM icon on the display will be lit. For details on how to set the protection modes, please see page 49.

| | |
|-------------------|--|
| OVP | Overvoltage protection (OVP) prevents a high voltage from damaging the load. |
| OCP | Overcurrent protection prevents high current from damaging the load. |
| OTP | Over temperature protection protects the instrument from overheating. |
| Power Switch Trip | When the Power Switch Trip configuration setting is enabled, the power supply will automatically shut down when a protection setting has been tripped (OCP, OVP, OTP). |
| Alarm output | Alarms are output via the analog control connector. The alarm output is an isolated open-collector photo coupler output. |

Considerations

The following situations should be taken into consideration when using the power supply.

Inrush current When the power supply switch is first turned on, an inrush current is generated. Ensure there is enough power available for the power supply when first turned on, especially if a number of units are turned on at the same time.



Caution

Allow at least 15 seconds between cycling the power. Cycling the power on and off quickly can cause the inrush current limiting circuit to fail as well as reduce the working life of the input fuse and power switch.

Pulsed or Peaked loads When the load has current peaks or is pulsed, it is possible for the maximum current to exceed the mean current value. The PSW power supply ammeter only indicates mean current values, which means for pulsed current loads, the actual current can exceed the indicated value. For pulsed loads, the current limit must be increased, or a power supply with a greater capacity must be chosen. As shown below, a pulsed load may exceed the current limit and the indicated current on the power supply ammeter.

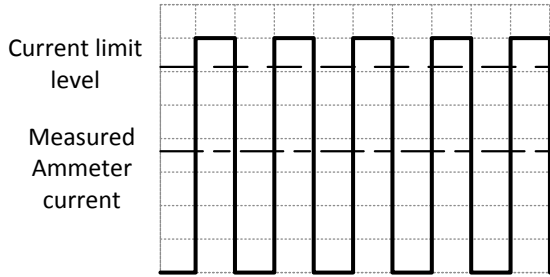

**Reverse Current:
Regenerative load**

When the power supply is connected to a regenerative load such as a transformer or inverter, reverse current will feed back to the power supply. The PSW power supply cannot absorb reverse current. For loads that create reverse current, connect a resistor in parallel to the power supply to bypass the reverse current. This description only applies when the bleed resistance is off.

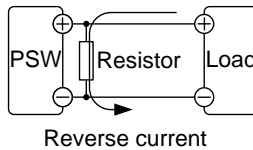

! Note

The current output will decrease by the amount of current absorbed by the resistor.

Ensure the resistor used can withstand the power capacity of the power supply/load.

Reverse Current:
Accumulative
energy.

When the power supply is connected to a load such as a battery, reverse current may flow back to the power supply. To prevent damage to the power supply, use a reverse-current-protection diode in series between the power supply and load.

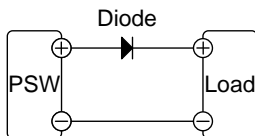

CAUTION

Ensure the reverse withstand voltage of the diode is able to withstand 2 times the rated output voltage of the power supply and the forward current capacity can withstand 3 to 10 times the rated output current of the power supply.

Ensure the diode is able to withstand the heat generated in the following scenarios.

When the diode is used to limit reverse voltage, remote sensing cannot be used.

Grounding

The output terminals of the PSW power supplies are isolated with respect to the protective grounding terminal. The insulation capacity of the load, the load cables and other connected devices must be taken into consideration when connected to the protective ground or when floating.

Floating

As the output terminals are floating, the load and all load cables must have an insulation capacity that is greater than the isolation voltage of the power supply.

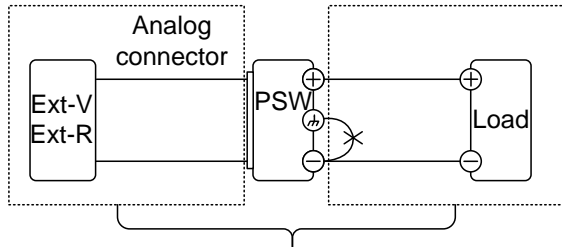

(-----) Insulation capacity \geq isolation voltage of power supply



WARNING

If the insulation capacity of the load and load cables is not greater than the isolation voltage of the power supply, electric shock may occur.

Grounded output terminal

If the positive or negative terminal is connected to the protective ground terminal, the insulation capacity needed for the load and load cables is greatly reduced. The insulation capacity only needs to be greater than the maximum output voltage of the power supply with respect to ground.

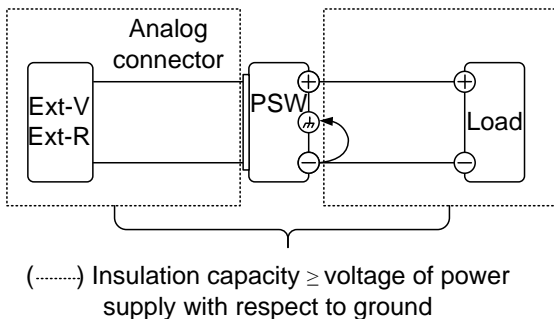

CAUTION

If using external voltage control, do not ground the external voltage terminal as this will create a short circuit.

PERATION

| | |
|--|-----------|
| Set Up | 35 |
| Line Voltage Connection – Type III Models..... | 35 |
| Filter Installation..... | 37 |
| Power Up..... | 38 |
| Wire Gauge Considerations..... | 39 |
| Output Terminals..... | 40 |
| Using the Output Terminal Cover..... | 42 |
| Using the Rack Mount Kit..... | 43 |
| How to Use the Instrument..... | 43 |
| Reset to Factory Default Settings..... | 45 |
| View System Version and Build Date..... | 46 |
| | |
| Basic Operation | 49 |
| Setting OVP/OCP Levels..... | 49 |
| Set to C.V. Mode..... | 51 |
| Set to C.C. Mode..... | 54 |
| Display Modes..... | 57 |
| Panel Lock..... | 58 |
| Remote Sense..... | 59 |
| | |
| Parallel / Series Operation | 62 |
| Master-Slave Parallel Overview..... | 63 |
| Master-Slave Parallel Connection..... | 65 |
| Master-Slave Parallel Operation..... | 68 |
| Master-Slave Series Overview..... | 70 |
| Master-Slave Series Connection..... | 72 |
| Master-Slave Series Operation..... | 74 |
| | |
| Test Scripts | 76 |
| Test Script File Format..... | 77 |
| Test Script Settings..... | 77 |
| Setting the Test Script Settings..... | 78 |
| Load Test Script from USB..... | 79 |

| | |
|---------------------------------|----|
| Run Test Script | 80 |
| Export Test Script to USB | 81 |
| Remove Test Script | 82 |

Set Up

Line Voltage Connection – Type III Models

Background The Type III (PSW 30-108/PSW 80-40.5/PSW 160-21.6) models use a universal power input that can be used with 100 and 200 VAC systems. To connect or replace the power cord (GW Instek part number: 4320-91001101, use the procedure below:



Warning

The following procedure should only be attempted by competent persons.

Ensure the AC power cord is not connected to power.

Removal

1. Turn off the power switch.

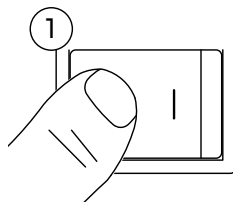

2. Unscrew the power cord protective sheath.
3. Remove the 2 screws holding the power cord cover and remove.

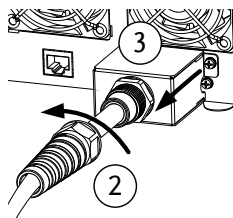

4. Slide the cover off the AC terminals.
5. Remove the AC power cord wires.

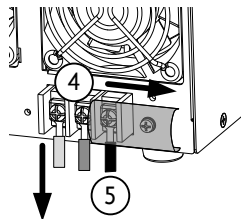

Installation

1. Connect the AC power cord wires to the AC input terminals.

- White/Blue → Neutral (N)
- Green/Green-yellow → GND (⊕)
- Black/Brown → Line (L)

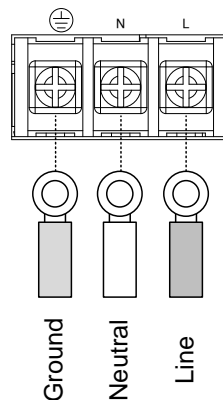

2. Set the cover back over the AC terminals.

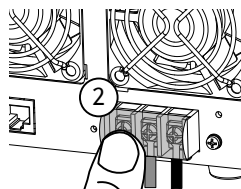

3. Re-install the power cord cover.
4. Screw the power cord sheath back onto the cover.

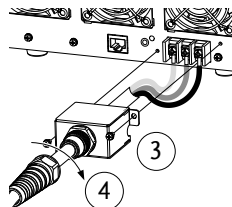

Filter Installation

Background The PSW has a small filter (GW Instek part number, 57RG-30B00101) that must first be inserted under the control panel before operation. The small filter must be inserted for all model types (Type I/II/II).

- Steps**
1. Insert the small filter in the open area under the control panel.



Type II shown as an example

2. The unit is now ready to power up.

Power Up

Steps

1. Type I or II: Connect the power cord to the rear panel socket.

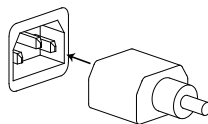

Type III: Connect the power cord to the universal power input.

Page 35

2. Press the POWER key. If used for the first time, the default settings will appear on the display, otherwise The PSW recovers the state right before the power was last turned OFF.

For default configuration settings, see page 139.

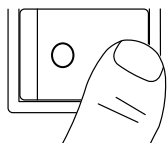

 **CAUTION**

The power supply takes around 8 seconds to fully turn on and shutdown.

Do not turn the power on and off quickly. Please wait for the display to fully turn off.

Wire Gauge Considerations

Background

Before connecting the output terminals to a load, the wire gauge of the cables should be considered.

It is essential that the current capacity of the load cables is adequate. The rating of the cables must equal or exceed the maximum current rated output of the instrument.

Recommended wire gauge

| Wire Gauge | Maximum Current |
|------------|-----------------|
| 20 | 2.5A |
| 18 | 4A |
| 16 | 6A |
| 14 | 10A |
| 12 | 16A |
| 10 | 21A |
| 8 | 36A |
| 6 | 61A |
| 4 | 97A |

Output Terminals

Background

Before connecting the output terminals to the load, first consider whether voltage sense will be used, the gauge of the cable wiring and the withstand voltage of the cables and load.

The output terminals can be connected to load cables using M4 sized screws or M8 sized bolts.



WARNING

Dangerous voltages. Ensure that the power to the instrument is disabled before handling the power supply output terminals. Failing to do so may lead to electric shock.

Steps

1. Turn the power switch off.

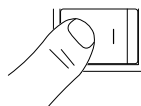

2. Remove the output terminal cover. [Page 42](#)

3. If necessary, screw the chassis ground terminal to either the positive or negative terminal. See [the grounding chapter for details.](#) [Page 31](#)

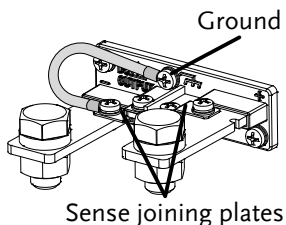

4. Choose a suitable wire gauge for the load cables. [Page 39](#)

5. Choose a suitable crimp for the terminals.
6. If using voltage sense, remove the Page 59 sense terminal joining plates and connect sensing wires to the load(s).
7. Connect the positive load cable to the positive output terminal and the negative cable to the negative output terminal.
8. Reattach the output terminal Page 42 cover.

Connection without sense wiring

Using M4 screws

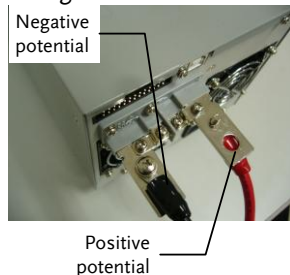

Using M8 bolts

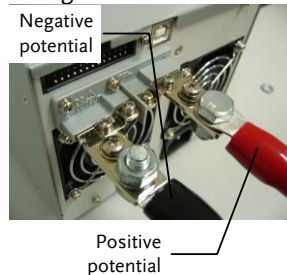

Connection with sense wiring

Using M4 screws

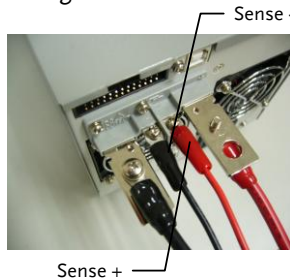

Using M8 bolts

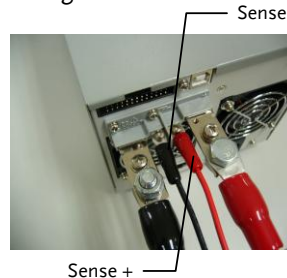

Using the Output Terminal Cover

Steps

1. Remove the screw holding the top cover to the bottom cover.
2. Line-up the bottom cover with the notches in the output terminals.
3. Place the top terminal cover over the bottom cover.

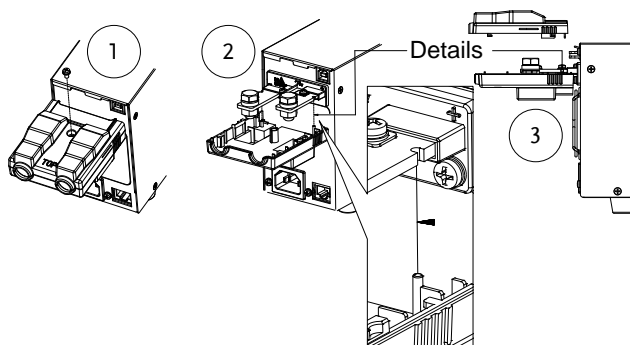

4. Use your thumb to slide the terminal covers shut, as shown in the diagram below.
5. When the top and bottom covers are flush, re-insert the screw that was removed in step 1.

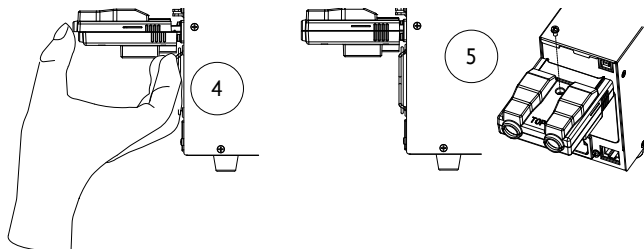

Removal Reverse the procedure to remove the terminal covers.

Using the Rack Mount Kit

Background The PSW series has an optional Rack Mount Kit (GW Instek part number: [JIS] GRA-410-J, [EIA] GRA-410-E[EIA]) that can be used to hold 6x PSW Type I models, 3x Type II models, 2x Type III models or a combination of all models (1x Type I, 1x Type II and 1x Type III).

Rack mount diagram

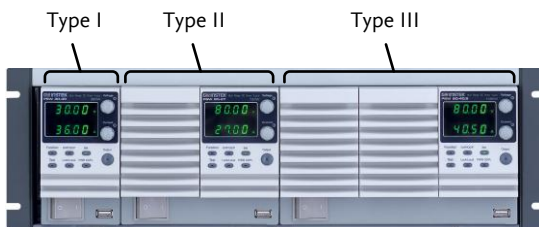

How to Use the Instrument

Background The PSW power supplies use a novel method of configuring parameter values only using the voltage or current knobs. The knobs are used to quickly edit parameter values at 0.01, 0.1 or 1 unit steps at a time.

When the user manual says to set a value or parameter, use the steps below.

Example Use the voltage knob to set a voltage of 10.05 volts.

1. Repeatedly press the voltage knob until the last digit is highlighted. This will allow the voltage to be edited in 0.01 volt steps.

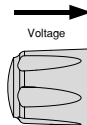

2. Turn the voltage knob till 0.05 volts is shown.

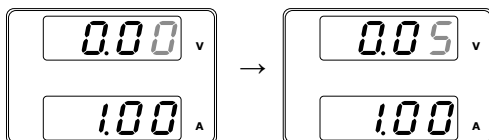
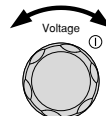

3. Repeatedly press the voltage knob until the first digit is highlighted. This will allow the voltage to be edited in 1 volt steps.
4. Turn the voltage knob until 10.05 is shown.

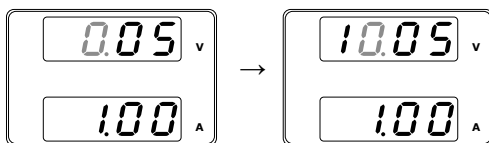





 **Note**

Notice the Set key becomes illuminated when setting the current or voltage.

If the voltage or current knobs are unresponsive, press the Set key first.

Reset to Factory Default Settings

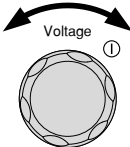
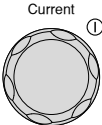
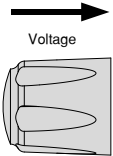
Background The F-88 configuration setting allows the PSW to be reset back to the factory default settings. See page 139 for the default factory settings.

- | | | |
|--------------|--|---|
| Steps | <ol style="list-style-type: none"> 1. Press the Function key. The Function key will light up. | <p>Function</p>  |
| | <ol style="list-style-type: none"> 2. The display should show F-01 on the top and the configuration setting for F-01 on the bottom. |  |
| | <ol style="list-style-type: none"> 3. Rotate the voltage knob to change the F setting to F-88 (Factory Set Value). | <p>Voltage</p>  |
| | <ol style="list-style-type: none"> 4. Use the current knob to set the F-88 setting to 1 (Return to factory settings). | <p>Current</p>  |
| | <ol style="list-style-type: none"> 5. Press the Voltage knob to confirm. ConF will be displayed when successful. | <p>Voltage</p>  |
| |  | |
| | <ol style="list-style-type: none"> 6. Press the Function key again to exit. The function key light will turn off. | <p>Function</p>  |

View System Version and Build Date

Background The F-89 configuration setting allows you to view the PSW version number, build date, keyboard version, analog-control version, kernel build, test command version and test command build date.

Steps

1. Press the Function key. The Function key will light up.

Function



2. The display should show F-01 on the top and the configuration setting for F-01 on the bottom.



3. Rotate the voltage knob to change the F setting to F-89 (Show Version).

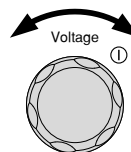

4. Rotate the current knob to view the version and build date for the various items.

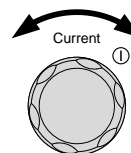

| | |
|------|--|
| F-89 | 0-XX: PSW Main Program Version 1-XX: PSW Main Program Version 2-XX: PSW Main Program Build On-Year. 3-XX: PSW Main Program Build On-Year. 4-XX: PSW Main Program Build On-Month. 5-XX: PSW Main Program Build On-Day. 6-XX: Keyboard CPLD version. 7-XX: Keyboard CPLD version. 8-XX: Analog CPLD version. 9-XX: Analog CPLD version. A-XX: Reserved. B-XX: Reserved. C-XX: Kernel Build On-Year. D-XX: Kernel Build On-Year. E-XX: Kernel Build On-Month. F-XX: Kernel Build On-Day. G-XX: Test Command Version. H-XX: Test Command Version. I-XX: Test Command Build On-Year. J-XX: Test Command Build On-Year. K-XX: Test Command Build On-Month. L-XX: Test Command Build On-Day. |
|------|--|

5. Press the Function key again to exit. The function key light will turn off.

Function



Example

Main Program Version: V01.09, 2011/08-01

0-01: PSW Main Program Version
 1-09: PSW Main Program Version
 2-20: PSW Main Program Build On-Year.
 3-11: PSW Main Program Build On-Year.
 4-08: PSW Main Program Build On-Month.
 5-01: PSW Main Program Build On-Day.

Example Keyboard CPLD Version: 0x030c

6-03: Keyboard CPLD Version.
7-0c: Keyboard CPLD Version.

Example Analog CPLD Version: 0x0421

8-04: Analog CPLD Version.
9-21: Analog CPLD Version.

Example Kernel Version: 2011/05/22

C-20: Kernel Build On-Year.
D-11: Kernel Build On-Year.
E-05: Kernel Build On-Month.
F-22: Kernel Build On-Day.

Example Test Command Version: V01:00, 2011/07/25

G-01: Test Command Version.
H-00: Test Command Version.
I-20: Test Command Build On-Year.
J-11: Test Command Build On-Year.
K-07: Test Command Build On-Month.
L-25: Test Command Build On-Day.

Basic Operation

This section describes the basic operations required to operate the power supply.

- Setting OVP/OCP → from page 49
- C.V. mode → from page 51
- C.C. mode → from page 54
- Display modes → page 57
- Panel lock → page 58
- Remote sensing → from page 59

Before operating the power supply, please see the Getting Started chapter, page 9.

Setting OVP/OCP Levels

The OVP level has a selectable range of 10% to 110% of the rated output voltage. The OCP level has a selectable range 10%~ 110% of the rated output current, alternatively the OCP level can also be turned off. The OVP and OCP level is set to 110% by default.

When one of the protection measures are on, ALM is shown on the panel display. By default, the power switch will turn off when any of the protection levels are tripped.



Before setting the OVP or OCP level:

- Ensure the load is not connected.
- Ensure the output is set to off.

Steps

1. Press the OVP/OCP key. The OVP/OCP key lights up.

OVP/OCP



2. The OVP setting will be displayed on the top and the OCP setting (or OFF) will be displayed on the bottom.

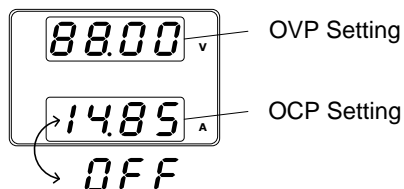

OVP Level

3. Use the voltage knob to set the OVP level.

Range 10%~110% of rated output voltage.

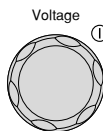

OCP Level

4. Use the current knob to set the OCP level.

Range 10%~110% of rated output current, OFF.

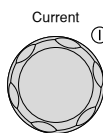

5. Press OVP/OCP again to exit. The OVP/OCP indicator will turn off.

OVP/OCP



Power switch trip

Set F-95 (Power switch trip) to 1 (to disable the power switch trip) or to 0 (to enable the power switch trip) and save.

Page 99

F-95 1 (Disable) or 0 (Enable)

Clear OVP/OCP protection

The OVP or OCP protection can be cleared after it has been tripped by holding the OVP/OCP button for 2 seconds.

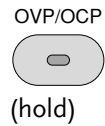

(Only applicable when the power switch trip setting is disabled [F-95 = 1])

Set to C.V. Mode

When setting the power supply to constant voltage mode, a current limit must also be set to determine the crossover point. When the current exceeds the crossover point, the mode switches to C.C. mode. For details about C.V. operation, see page 21. C.C. and C.V. mode have two selectable slew rates: High Speed Priority and Slew Rate Priority. High Speed Priority will use the fastest slew rate for the instrument while Slew Rate Priority will use a user-configured slew rate.

Background

Before setting the power supply to C.V. mode, ensure:

- The output is off.
- The load is connected.

Steps

1. Press the Function key. The Function key will light up.



2. The display should show F-01 on the top and the configuration setting for F-01 on the bottom.



3. Rotate the voltage knob to change the F setting to F-03 (V-I Mode Slew Rate Select).

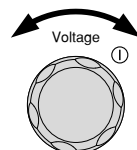

4. Use the current knob to set the F-03 setting.

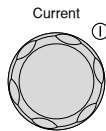

Set F-03 to 0 (CV High Speed Priority) or 2 (CV Slew Rate Priority).

F-03 0 = CV High Speed Priority
 2 = CV Slew Rate Priority

5. Press the Voltage knob to save the configuration setting. ConF will be displayed when successful.

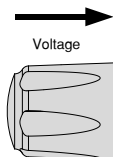

6. If CV Slew Rate Priority was chosen as the operating mode, repeat steps 3~5 to set F-04 (Rising Voltage Slew Rate) and the F-05 (Falling Voltage Slew Rate) and save.

F-04 / F-05 0.1V/s~60V/s (PSW 30-XX)
 0.1V/s~160V/s (PSW 80-XX)
 0.1V/s~320V/s (PSW160-XX)

7. Press the Function key again to exit the configuration settings. The function key light will turn off.



8. Use the Current knob to set the current limit (crossover point).

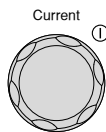

9. Use the Voltage knob to set the voltage.

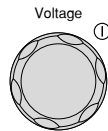

Note

Notice the Set key becomes illuminated when setting the current or voltage. If the voltage or current knobs are unresponsive, press the Set key first.

10. Press the Output key. The Output key becomes illuminated.

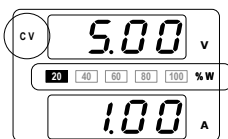
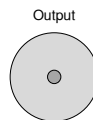

CV and the Power Bar will become illuminated (top left & center)



Note

Only the voltage level can be altered when the output is on. The current level can only be changed by pressing the Set key.

For more information on the Normal Function Settings (F-00 ~ F-61, F-88~F-89) see page 89.

Set to C.C. Mode

When setting the power supply to constant current mode, a voltage limit must also be set to determine the crossover point. When the voltage exceeds the crossover point, the mode switches to C.V. mode. For details about C.C. operation, see page 21. C.C. and C.V. mode have two selectable slew rates: High Speed Priority and Slew Rate Priority. High Speed Priority will use the fastest slew rate for the instrument while Slew Rate Priority will use a user-configured slew rate.

Background Before setting the power supply to C.C. mode, ensure:

- The output is off.
- The load is connected.

Steps

1. Press the Function key. The Function key will light up.

Function



2. The display should show F-01 on the top and the configuration setting for F-01 on the bottom.

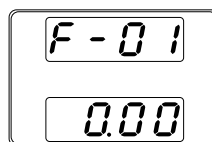

3. Rotate the voltage knob to change the F setting to F-03 (V-I Mode Slew Rate Select).

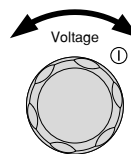

4. Use the current knob to set the F-03 setting.

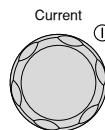

Set F-03 to 1 (CC High Speed Priority) or 3 (CC Slew Rate Priority) and save.

F-03 1 = CC High Speed Priority
 3 = CC Slew Rate Priority

5. Press the Voltage knob to save the configuration setting. Conf will be displayed when successful.

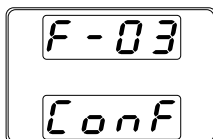
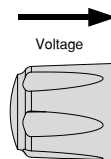

6. If CC Slew Rate Priority was chosen as the operating mode, set F-06 (Rising Current Slew Rate) and F-07 (Falling Current Slew Rate) and save.

F-06 / F-07 0.01A/s~72.00A/s (PSW 30-36)
 0.01A/s~144.0A/s (PSW 30-72)
 0.01A/s~216.0A/s (PSW 30-108)
 0.01A/s~27.00A/s (PSW 80-13.5)
 0.01A/s~54.00A/s (PSW 80-27)
 0.01A/s~81.00A/s (PSW 80-40.5)
 0.01A/s~14.40A/s (PSW 160-7.2)
 0.01A/s~28.80A/s (PSW 160-14.4)
 0.01A/s~43.20A/s (PSW 160-21.6)

7. Press the Function key again to exit the configuration settings. The function key light will turn off.

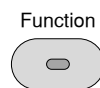

8. Use the Voltage knob to set the voltage limit (crossover point).

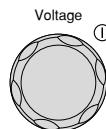

9. Use the Current knob to set the current.

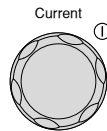

Note

Notice the Set key becomes illuminated when setting the current or voltage. If the voltage or current knobs are unresponsive, press the Set key first.

10. Press the Output key. The Output key becomes illuminated.

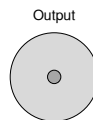

CC and the Power Bar will become illuminated (bottom left & center)



Note

Only the current level can be altered when the output is on. The voltage level can only be changed by pressing the Set key.

For more information on the Normal Function Settings (F-00 ~ F-61, F-88~F-89) see page 89.

Display Modes

The PSW power supplies allow you to view the output in three different modes: voltage and current, voltage and power or current and power.

Steps

1. Press the PWR/DSPL key. The PWR DSPL key lights up. 
2. The display changes to voltage and power (V/W).
3. To switch between displaying A/W and V/W, simply press the corresponding voltage or current knob.

For example: when in A/W mode, press the voltage knob to display V/W. Conversely when in V/W mode, press the current knob to display A/W.

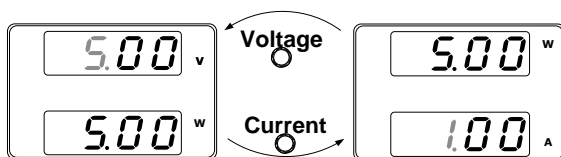

- When V/W is displayed, the voltage knob can still be used to change the voltage level.
 - When A/W is displayed, the current knob can still be used to change the current level.
-



Exit

Press the PWR/DSPL key again to return to normal display mode. The PWR DSPL light will turn off. 

Panel Lock

The panel lock feature prevents settings from being changed accidentally. When activated, the Lock/Local key will become illuminated and all keys and knobs except the Lock/Local key and Output key (if active) will be disabled.

If the instrument is remotely controlled via the USB/LAN interface, the panel lock is automatically enabled.

| | | |
|--------------------------------|--|---|
| <p>Activate the panel lock</p> | <p>Press the Lock/Local key to activate the panel lock. The key will become illuminated.</p> | <p>Lock/Local</p>  |
| <p>Disable the panel lock</p> | <p>Hold the Lock/Local key for ~3 seconds to disable the panel lock. The Lock/Local light turns off.</p> | <p>Lock/Local</p>  |

Remote Sense

Remote sense is used to compensate for the voltage drop seen across load cables due to the resistance inherent in the load cables. The remote sense terminals are connected to the load terminals to determine the voltage drop across the load cables.

Remote sense can compensate up to 0.6 volts (compensation voltage). Load cables should be chosen with a voltage drop less than the compensation voltage.



WARNING

Ensure the output is off before connecting any sense cables.

Use sense cables with a voltage rating exceeding the isolation voltage of the power supply.

Never connect sensing cables when the output is on. Electric shock or damage to the power supply could result.



Note

Be sure to remove the Sense joining plates so the units are not using local sensing.

Single Load

1. Connect the Sense+ terminal to the positive potential of the load. Connect the Sense- terminal to the negative potential of the load.

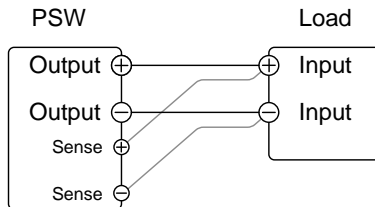

Page 40

2. Operate the instrument as normal. See the Basic Operation chapter for details.

Parallel PSW Units

1. Connect the Sense+ terminals to the positive potential of the load. Connect the Sense- terminals to the negative potential of the load.

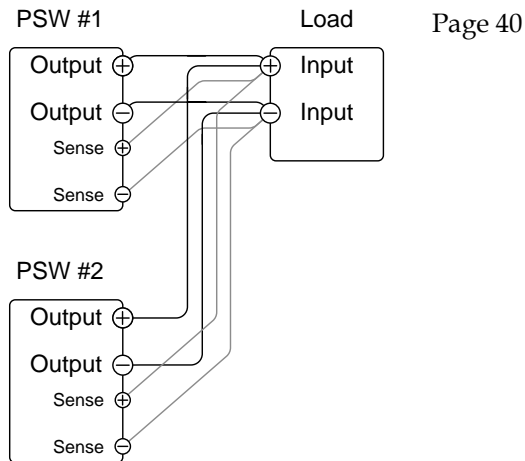

2. Operate the instrument as normal. See the Parallel Operation chapter for details. Page 63

Serial PSW Units

1.
 - a. Connect the 1st Sense+ terminal to the positive potential of the load.
 - b. Connect the 1st Sense- terminal to the positive output terminal of the second PSW unit.
 - c. Connect the 2nd Sense+ terminal to the positive terminal of the second PSW unit.
 - d. Connect the 2nd Sense- terminal to negative terminal of the load.

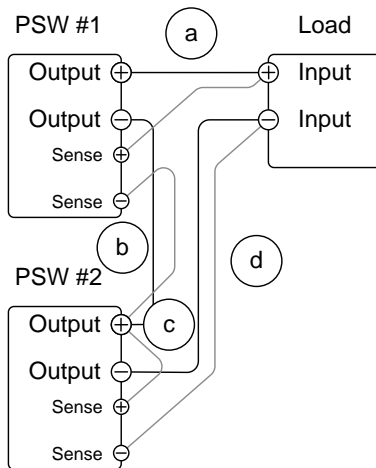

2. Operate the instrument as normal. Page 70
See the Serial Operation chapter for details.

Wire Shielding and Load line impedance

To help to minimize the oscillation due to the inductance and capacitance of the load cables, use an electrolytic capacitor in parallel with the load terminals.

To minimize the effect of load line impedance use twisted wire pairing.

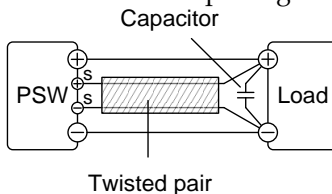

Parallel / Series Operation

This section describes the basic operations required to operate the power supply in series or parallel. Operating the PSW series in parallel increases the total power output of the power supply units. When used in series, the total output voltage of the power supplies can be increased.

The number of the power supplies that can be connected in series or parallel depends on the model and the mode:

- Series Mode: 2 units maximum
- Parallel Mode: 3 units maximum

To use the power supplies in series or parallel, units must be used in a Master-Slave configuration. In the master-slave configuration a “master” power supply controls any other connected “slave” power supplies.

- Master-Slave Parallel overview → from page 63
- Parallel connection → from page 65
- Parallel operation → from page 68
- Master-Slave Series overview → page 70
- Series connection → page 72
- Series operation → from page 74

Before operating the power supply, please see the Getting Started chapter, page 9.

Master-Slave Parallel Overview

Background

When connecting the PSW power supplies in parallel, up to 3 units can be used in parallel and all units must be of the same model.

When the units are used in parallel, a number of precautions and limitations apply. Please read this overview before operating the power supplies in parallel.

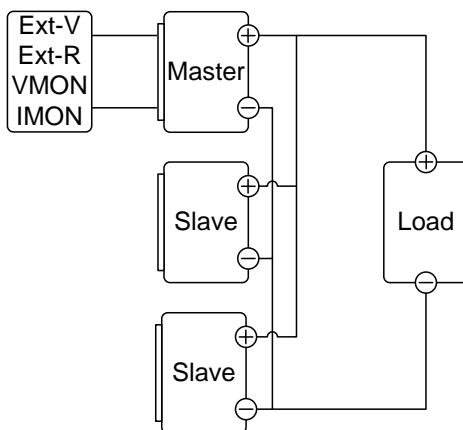

Limitations

Display

- Only the master unit will display the voltage and current.

OVP/ OCP

- The master unit can shut down slave units when OVP/OCP is tripped on the master unit (if the slave connector is wired for shut down on alarm).
- OVP/OCP can be independently tripped on each slave unit, however the shutdown of the power or output of the unit is disabled. Only the alarm will be enabled.

Remote monitoring

- Voltage monitoring (VMON) and current monitoring (IMON) are only supported on the master unit.
- The IMON current represents the total current of the all the parallelized units.

Remote Sense

- Please see the remote sense chapter for details, page 59.

External Voltage and Resistance Control

- Voltage/Resistance controlled remote control can only be used with the master unit.
- The full scale current (in parallel) is equivalent to the maximum external voltage or resistance.

Internal Resistance

- For 2 units in parallel, the internal resistance is actually half of the setting value.
- For 3 units in parallel, the internal resistance is actually a third of the setting value.

Bleeder Control

- The Master unit is used to control the bleeder settings. The bleeder resistors in all the slave units are always turned off when in parallel mode.

| | Model | Single unit | 2 units | 3 units |
|-----------------------------------|--------------|-------------|---------|---------|
| Output Voltage/ Output Current | PSW 30-36 | 30V | 30V | 30V |
| | | 36A | 72A | 108A |
| | PSW 80-13.5 | 80V | 80V | 80V |
| | | 13.5A | 27A | 40.5A |
| | PSW 160-7.2 | 160V | 160V | 160V |
| | | 7.2A | 14.4A | 21.6A |
| | PSW 30-72 | 30V | 30V | 30V |
| | | 72A | 144A | 216A |
| | PSW 80-27 | 80V | 80V | 80V |
| | | 27A | 54A | 81A |
| | PSW 160-14.4 | 160V | 160V | 160V |
| | | 14.4A | 28.8A | 43.2A |
| | PSW 30-108 | 30V | 30V | 30V |
| | | 108A | 216A | 324A |
| | PSW 80-40.5 | 80V | 80V | 80V |
| | | 40.5A | 81A | 121.5A |
| | PSW 160-21.6 | 160V | 160V | 160V |
| | | 21.6A | 43.2A | 64.8A |

Master-Slave Parallel Connection

Master-Slave Connector

The Analog Control Connector is used for both serial and parallel connections. The way the connector is configured determines the behavior of the master and slave units. For the complete connector pin assignment, see page 102.

Analog Connector Connection To operate the power supplies in parallel, connect the analog connectors on the master and slave units as shown in the diagrams below.

Master with 2 slave units:

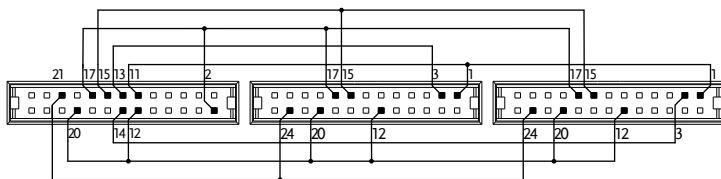

| Master unit | Slave Unit 1 | Slave Unit 2 |
|---------------------|--------------------|--------------------|
| 11 I MON | 1 CURRENT SHARE | 1 CURRENT SHARE |
| 21 OUTPUT ON STATUS | 24 OUT ON/OFF CONT | 24 OUT ON/OFF CONT |
| 20 ALM STATUS | 12 SHUTDOWN | 12 SHUTDOWN |
| 17 STATUS COM | 17 STATUS COM | 17 STATUS COM |
| 15 FEEDBACK | 15 FEEDBACK | 15 FEEDBACK |
| 14 CURRENT_SUM_2 | | 3 CURRENT SUM OUT |
| 13 CURRENT_SUM_1 | 3 CURRENT SUM OUT | |
| 12 SHUTDOWN | 20 ALM STATUS | 20 ALM STATUS |
| 2 D COM | | |

Master with 1 slave unit:

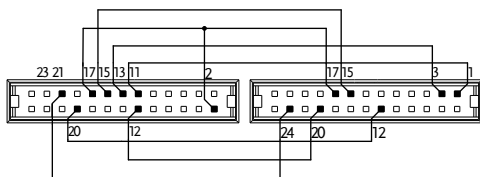

| Master unit | Slave Unit 1 |
|---------------------|--------------------|
| 11 I MON | 1 CURRENT SHARE |
| 21 OUTPUT ON STATUS | 24 OUT ON/OFF CONT |
| 20 ALM STATUS | 12 SHUTDOWN |
| 17 STATUS COM | 17 STATUS COM |
| 15 FEEDBACK | 15 FEEDBACK |
| 13 CURRENT_SUM_1 | 3 CURRENT SUM OUT |
| 12 SHUTDOWN | 20 ALM STATUS |
| 2 D COM | |

Parallel Output Connection

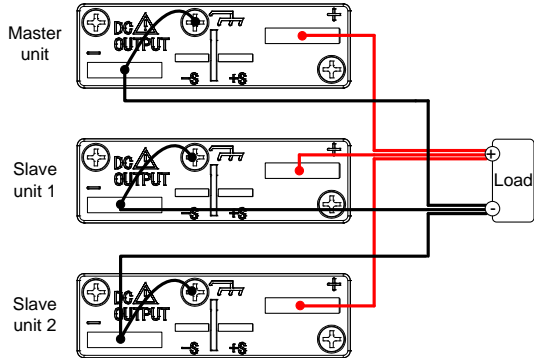

Steps

1. Ensure the power is off on all power supplies.
2. Choose a master and a slave unit(s).
3. Connect the analog connectors for the master and slave unit as shown above.
4. Remove the Output Terminal covers and the protection dummy plug from the analog control connector. Page 42
5. Connect the master and slave unit in parallel as shown above.
6. Reattach the terminal covers. Page 42

 Note

Ensure the load cables have sufficient Page 39 current capacity.

Re-attach the Protection dummy plug when not in use.

Master-Slave Parallel Operation

Master-Slave Configuration Before using the power supplies in parallel, the master and slave units need to be configured.

Steps 1. Configure the OVP and OCP settings for the master unit. Page 49

2. For each unit, hold the Function key while turning the power on to enter the power on configuration settings.

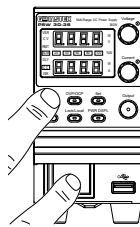

3. Configure F-93 (Master/Slave) setting for each master/slave unit. Page 99

| Unit | F-93 |
|------------------------------------|------|
| Master (with 1 slave in parallel) | 1 |
| Master (with 2 slaves in parallel) | 2 |
| Slave unit (parallel slave) | 3 |

4. Cycle the power on the units (reset the power).

 **Note**

Configuration settings can be checked for both the master and slave units by pressing the Function key and checking F-93.

Only the Master OVP and OCP level is used for over voltage and current protection. Slave OVP and OCP level is disregarded.

OTP works independently for each unit.

Master-Slave Operation

Only operate the power supplies in parallel if the units are configured correctly.

1. Turn on the master and slave units. The slave unit(s) will show a blank display.

Master unit



Slave units

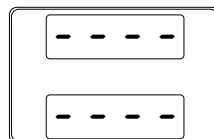

2. Operation of all units is controlled via the master unit. Operation of the master unit is the same as for a single unit. See the Basic Operation chapter. Page 45.

3. Press the Output key to begin.

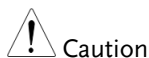
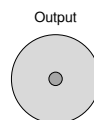

Caution

Only operate the power supplies in parallel if using units of the same model number.

Only a maximum of 3 units can be used in parallel.



Note

The panel controls are disabled on slave units, including the output key. On slave units only the Function key can be used to view the current settings.

Master-Slave Series Overview

Background

When connecting PSW power supplies in series, up to 2 units can be used in series and all units must be of the same model.

When the units are used in series, a number of precautions and limitations apply. Please read this overview before operating the power supplies in series.

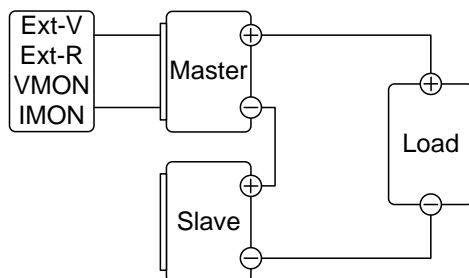

Limitations

Display

- Only the master unit will display the current.
- Master and slave units display the voltage. The total voltage is the sum of the units.

OVP/OCP

- The master unit can shut down the slave unit when OVP/OCP is tripped on the master unit (if the slave connector is wired for shut down on alarm).
- OVP and OCP level is determined by the master OVP and OCP level. The OVP and OCP level on the slave unit is ignored.

Remote monitoring

- Voltage monitoring (VMON) and current monitoring (IMON) are only supported on the master unit.
- The VMON voltage represents the total voltage of the all the serialized units.

Remote Sense

- Please see the remote sense chapter for details, page 59.

External Voltage and Resistance Control

- Voltage/Resistance controlled remote control can only be used with the master unit.
- The full scale voltage (in series) is equivalent to the maximum external voltage or resistance.

Slew Rate

- The actual slew rate is double that of the setting slew rate. I.e., A slew rate setting of 60.00V/s is actually 120V/s when in series.

Internal Resistance

- The internal resistance is actually twice that of the setting value.

Bleeder Control

- The Master unit is used to control the bleeder settings. The bleeder resistor is always turned on for the slave unit in series mode.

| | Model | Single unit | 2 units |
|-----------------------------------|--------------|-------------|---------|
| Output Voltage/ Output Current | PSW 30-36 | 30V | 60V |
| | | 36A | 36A |
| | PSW 80-13.5 | 80V | 160V |
| | | 13.5 | 13.5A |
| | PSW 160-7.2 | 160V | 320V |
| | | 7.2A | 7.2A |
| | PSW 30-72 | 30V | 60V |
| | | 72A | 72A |
| | PSW 80-27 | 80V | 160V |
| | | 27A | 27A |
| | PSW 160-14.4 | 160V | 320V |
| | | 14.4A | 14.4A |
| | PSW 30-108 | 30V | 60V |
| | | 108A | 108A |
| | PSW 80-40.5 | 80V | 160V |
| | | 40.5A | 40.5A |
| | PSW 160-21.6 | 160V | 320V |
| | | 21.6A | 21.6A |

Master-Slave Series Connection

Master-Slave Connector

The Analog Control Connector is used for both serial and parallel connections. The way the connector is configured determines the behavior of the master and slave units. For the connector pin assignment, see page 102.

Analog Connector Connection

To operate the power supplies in series, connect the analog connectors on the master and slave unit as shown in the diagram below.

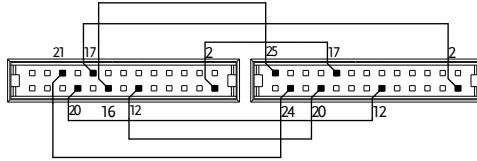

| Master unit | | Slave Unit 1 | |
|-------------|------------------|--------------|-----------------|
| 16 | A COM | 25 | SER SLV IN |
| 21 | OUTPUT ON STATUS | 24 | OUT OFF/ON CONT |
| 20 | ALM STATUS | 12 | SHUTDOWN |
| 17 | STATUS COM | 2 | D COM |
| 12 | SHUTDOWN | 20 | ALM STATUS |
| 2 | D COM | 17 | STATUS COM |

Series Output Connection

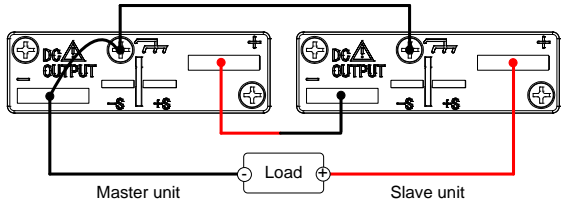

Steps

1. Ensure the power is off on both power supplies.
2. Choose a master and slave unit.
3. Connect the analog connectors for the master and slave unit as shown above.
4. Remove the output terminal cover [Page 42](#) and the protection dummy plug from the analog control connector.
5. Connect the master and slave unit in series as shown above.
6. Reattach the terminal cover. [Page 42](#)

 **Note**

Ensure load cables have sufficient [Page 39](#) current capacity.

Re-attach the protection dummy plug when not in use.

Master-Slave Series Operation

Master-Slave Configuration

Before using the power supplies in series, the master and slave units need to be configured.

1. Configure the OVP and OCP settings for the master unit. Page 49

2. For each unit, hold the Function key while turning the power on to enter the power on configuration settings.

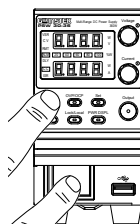

3. Configure F-93 (Master/Slave) setting for each master/slave unit. Page 99

| Unit | F-93 |
|------------------------------------|------|
| Master (local or series operation) | 0 |
| Slave unit (series) | 4 |

4. Cycle the power on the units (reset the power).

 **Note**

Configuration settings can be checked for both the master and slave units by pressing the Function key.

Master-Slave Operation

Only operate the power supplies in series if the units are configured correctly.

1. Turn on the master and slave unit. The slave unit will only show the voltage of its own unit. The master unit will show the combined voltage of both units and the current.

Master unit



Slave unit

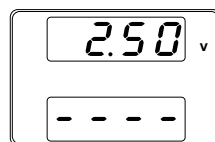

2. Operation of all units is controlled via the master unit. Operation of the master unit is the same as for a single unit. Please see the basic operation chapter for details.
3. Press the Output key to begin.

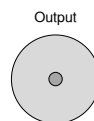

Only operate the power supplies in series if using units of the same model number.

Only a maximum of 2 units can be used in series.



The panel controls are disabled on slave units, including the output key.

Test Scripts

This section describes how to use the Test function to run, load and save test scripts for automated testing. The Test function is useful if you want to perform a number of tests automatically. The PSW test function can store ten test scripts in memory.

Each test script is programmed in a scripting language. For more information on how to create test scripts, please contact GW Instek.

- Test Script File Format → from page 77
- Test Script Settings → from page 77
- Setting the Test Script Settings → from page 78
- Load Test Script → from page 79
- Run Test Script → from page 80
- Export Test Script → from page 81
- Remove Test Script → from page 82

Test Script File Format

| | |
|------------|--|
| Background | The test files are saved in *.tst file format. Each file is saved as tXXX.tst, where XXX is the save file number 001~010. |
|------------|--|

Test Script Settings

| | |
|-------------|--|
| Test Run | Runs the chosen test script from the internal memory. A script must first be loaded into the internal memory before it can be run. See the test function Test Save, below. The script will run as soon as the test function is started. |
| | T-01 1~10 |
| Test Load | Loads a test script from the USB drive to the designated save slot in memory. A script must first be loaded into internal memory before it can be run. |
| | T-02 1~10 (USB→PSW) |
| Test Export | Exports a script from the designated memory save slot to the USB drive. |
| | T-03 1~10 (PSW→USB) |
| Test Remove | Deletes the chosen test file from the PSW internal memory. |
| | T-04 1~10 |

Setting the Test Script Settings

Steps The test script settings (T-01~T-04) are set with the Test key.

1. Press the Test key. The Test key will light up.



2. The display will show T-01 on the top and the memory no. for T-01 on the bottom.

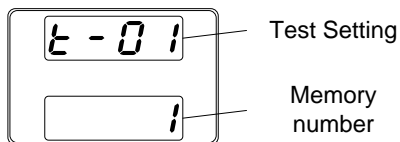

3. Rotate the voltage knob to change the T setting (Test setting).

| | |
|-------------|------|
| Test Run | T-01 |
| Test Load | T-02 |
| Test Export | T-03 |
| Test Remove | T-04 |

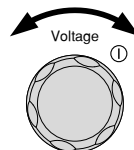

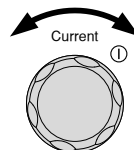

4. Rotate the current knob to choose a memory number.

| | |
|-------|------|
| Range | 1~10 |
|-------|------|

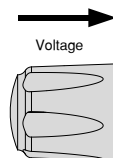

5. Press the Voltage knob to complete the setting.



Exit Press the Test key again to exit the Test settings. The Test key light will turn off. 

Load Test Script from USB

Overview Before a test script can be run, it must first be loaded into a one of the 10 memory save slots. Before loading a test script into memory:

- Ensure the script file is placed in the root directory.
- Ensure the file name number corresponds to the memory number that you wish to save to.

For example: A test file named t001.tst can only be saved to memory number 01, t002.tst can only be saved to memory number 02, and so on.

- Steps
1. Insert a USB flash drive into the front panel USB-A slot. Ensure the flash drive contains a test script in the root directory. 
 2. Turn on the power. MS (Mass Storage) will be displayed on the screen after a few seconds if the USB drive is recognized.

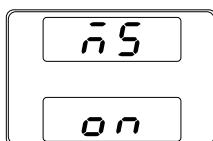



Note

If the USB drive is not recognized, check to see that the function settings for F-20 = 1 (page 93). If not, reinsert the USB flash drive.

3. Configure T-02 (Test Load) to 1~10 Page 78 (save memory slot)
T-02 range 1~10 (t001 ~t010)
4. The script will now be available in the memory slot the script was saved to.



Note

Error messages: If you load a file that is not present on the USB drive “Err 002” will be displayed on the display.

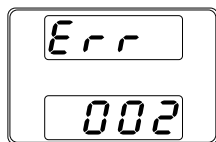

Run Test Script

Overview

A test script can be run from one of ten memory slots.

Steps

1. Before a test script can be run, it must first be loaded into one of the 10 memory save slots. Page 79
2. Configure T-01 (Run Test) to 1~10 Page 78 (save memory slot)
T-01 range 1~10
3. The test script will automatically start to run.



Note

Error messages: If you try to run a test script from an empty memory location “Err 003” will be displayed on the display.

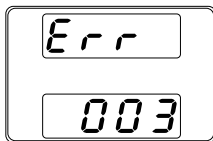

Note

When a script starts to run, there is no way to abort the script. Pressing the Output key has no effect. If you wish to stop a test early, turn the power off.

Export Test Script to USB

Overview

The Export Test function saves a test file to the root directory of a USB flash drive.

- Files will be saved as tXXX.tst where XXX is the memory number 001~010 from which the test script was exported from.
- Files of the same name on the USB flash drive will be written over.

Steps

1. Insert a USB flash drive into the front panel USB-A slot.

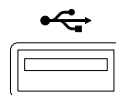

2. Turn on the power. MS (Mass Storage) will be displayed on the screen after a few seconds if the USB drive is recognized.

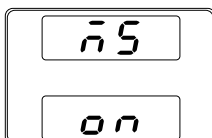



Note

If the USB drive is not recognized, check to see that the function settings for F-20 = 1 (page 93). If not, reinsert the USB flash drive.

3. Configure T-03 (Test Export) to 0~10 (save memory slot)
T-03 range 1~10 Page 78
4. The script will now be copied to the USB flash drive.



Note

Error messages: If you try to export a test script from an empty memory location “Err 003” will be displayed on the display.



Remove Test Script

Overview

The Remove Test function will delete a test script from the internal memory.

Steps

1. Select T-04 (Test Remove) and choose which test script to remove from the internal memory.
T-04 range 1~10 Page 78
2. The test script will be removed from the internal memory.



Error messages: If you try to remove a test script from an empty memory location “Err 003” will be displayed on the display.

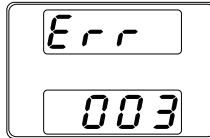

CONFIGURATION

| | |
|---------------------------------------|-----------|
| Configuration | 85 |
| Configuration Table | 85 |
| Normal Function Settings | 89 |
| USB/GPIB Settings | 93 |
| LAN Settings | 94 |
| System Settings | 95 |
| Power On Configuration Settings | 96 |
| Calibration | 97 |

Configuration

Configuration of the PSW power supplies is divided into five different configuration settings: Normal Function, USB/GPIB, LAN, Power ON Configuration, Calibration Settings and System Settings. Power ON Configuration differs from the other settings in that the settings used with Power ON Configuration settings can only be set during power up. The other configuration settings can be changed when the unit is already on. This prevents some important configuration parameters from being changed inadvertently. Power On Configuration settings are numbered F-90 to F-95 and the other configuration settings are numbered F-00 to F-61 and F-88 to F-89.

Configuration Table

Please use the configuration settings listed below when applying the configuration settings.

| Normal Function Settings | | |
|---------------------------|---------|--|
| Settings | Setting | Setting Range |
| Output ON delay time | F-01 | 0.00s~99.99s |
| Output OFF delay time | F-02 | 0.00s~99.99s |
| V-I mode slew rate select | F-03 | 0 = CV high speed priority 1 = CC high speed priority 2 = CV slew rate priority 3 = CC slew rate priority |
| Rising voltage slew rate | F-04 | 0.01V/s~60.00V/s (PSW 30-XX) 0.1V/s~160.0V/s (PSW 80-XX) 0.1V/s~320.0V/s (PSW 160-XX) |
| Falling voltage slew rate | F-05 | 0.01V/s~60.00V/s (PSW 30-XX) 0.1V/s~160.0V/s (PSW 80-XX) 0.1V/s~320.0V/s (PSW 160-XX) |

| | | |
|-----------------------------|------|---|
| Rising current slew rate | F-06 | 0.01A/s~72.00A/s (PSW 30-36) |
| | | 0.1A/s~144.0A/s (PSW 30-72) |
| | | 0.1A/s~216.0A/s (PSW 30-108) |
| | | 0.01A/s~27.00A/s (PSW 80-13.5) |
| | | 0.01A/s~54.00A/s (PSW 80-27) |
| | | 0.01A/s~81.00A/s (PSW 80-40.5) |
| | | 0.01A/s~14.40A/s (PSW 160-7.2) |
| | | 0.01A/s~28.80A/s (PSW 160-14.4) |
| | | 0.01A/s~43.20A/s (PSW 160-21.6) |
| Falling current slew rate | F-07 | 0.01A/s~72.00A/s (PSW 30-36) |
| | | 0.1A/s~144.0A/s (PSW 30-72) |
| | | 0.1A/s~216.0A/s (PSW 30-108) |
| | | 0.01A/s~27.00A/s (PSW 80-13.5) |
| | | 0.01A/s~54.00A/s (PSW 80-27) |
| | | 0.01A/s~81.00A/s (PSW 80-40.5) |
| | | 0.01A/s~14.40A/s (PSW 160-7.2) |
| | | 0.01A/s~28.80A/s (PSW 160-14.4) |
| | | 0.01A/s~43.20A/s (PSW 160-21.6) |
| Internal resistance setting | F-08 | 0.000Ω~0.833Ω (PSW 30-36) |
| | | 0.000Ω~0.417Ω (PSW 30-72) |
| | | 0.000Ω~0.278Ω (PSW 30-108) |
| | | 0.000Ω~5.926Ω (PSW 80-13.5) |
| | | 0.000Ω~2.963Ω (PSW 80-27) |
| | | 0.000Ω~1.975Ω (PSW 80-40.5) |
| | | 0.000Ω~22.222Ω (PSW 160-7.2) |
| | | 0.000Ω~11.111Ω (PSW 160-14.4) |
| | | 0.000Ω~7.407Ω (PSW 160-21.6) |
| Bleeder circuit control | F-09 | 0 = OFF, 1 = ON |
| Buzzer ON/OFF control | F-10 | 0 = ON, 1 = OFF |
| USB/GPIB settings | | |
| Front panel USB State | F-20 | 0 = Absent, 1 = Mass Storage |
| Rear panel USB State | F-21 | 0 = Absent, 2 = USB-CDC, 3 = GPIB-USB adapter |
| Rear panel USB mode | F-22 | 0 = Disable, 1 = GPIB-USB adapter, 2 = USB CDC, USB CDC Full Speed Only |
| GPIB address | F-23 | 0~30 |
| LAN settings | | |
| MAC Address-1 | F-30 | 0x00~0xFF |
| MAC Address-2 | F-31 | 0x00~0xFF |

| | | |
|------------------------|------|---|
| MAC Address-3 | F-32 | 0x00~0xFF |
| MAC Address-4 | F-33 | 0x00~0xFF |
| MAC Address-5 | F-34 | 0x00~0xFF |
| MAC Address-6 | F-35 | 0x00~0xFF |
| LAN | F-36 | 0 = Disable, 1 = Enable |
| DHCP | F-37 | 0 = Disable, 1 = Enable |
| IP Address-1 | F-39 | 0~255 |
| IP Address-2 | F-40 | 0~255 |
| IP Address-3 | F-41 | 0~255 |
| IP Address-4 | F-42 | 0~255 |
| Subnet Mask-1 | F-43 | 0~255 |
| Subnet Mask-2 | F-44 | 0~255 |
| Subnet Mask-3 | F-45 | 0~255 |
| Subnet Mask-4 | F-46 | 0~255 |
| Gateway-1 | F-47 | 0~255 |
| Gateway-2 | F-48 | 0~255 |
| Gateway-3 | F-49 | 0~255 |
| Gateway-4 | F-50 | 0~255 |
| DNS address -1 | F-51 | 0~255 |
| DNS address -2 | F-52 | 0~255 |
| DNS address-3 | F-53 | 0~255 |
| DNS address-4 | F-54 | 0~255 |
| Sockets active | F-57 | 0 = Disable, 1 = Enable |
| Web Server active | F-59 | 0 = Disable, 1 = Enable |
| Web password active | F-60 | 0 = Disable, 1 = Enable |
| Web setting password | F-61 | 0000~9999 |
| System Settings | | |
| Factory Set Value | F-88 | 0 = Disable 1 = Return to factory settings |

| | | |
|---|------|---|
| | | 0, 1 = PSW version 2, 3 = PSW build year 4, 5 = PSW build month/day 6, 7 = Keyboard CPLD version 8, 9 = Analog-Control CPLD version A, B = Reserved C, D = Kernel build year E, F = Kernel build month/day G, H = Test command version I, J = Test command build year K, L = Test command build month/day |
| Show Version | F-89 | |
| Power On Configuration Settings* | | |
| | | 0 = Panel control (local) 1 = External voltage control 2 = External resistance control (Ext-R \searrow 10k Ω = Vo, max) 3 = External resistance control (Ext-R \swarrow 10k Ω = 0) |
| CV Control | F-90 | |
| | | 0 = Panel control (local) 1 = External voltage control 2 = External resistance control (Ext-R \searrow 10k Ω = Io, max) 3 = External resistance control (Ext-R \swarrow 10k Ω = 0) |
| CC Control | F-91 | |
| Power-ON Output | F-92 | 0 = OFF at startup, 1 = On at startup |
| Master/Slave | F-93 | 0 = Master/Local 1 = Master/Parallel1 2 = Master/Parallel2 3 = Slave/Parallel 4 = Slave/Series |
| External Out Logic | F-94 | 0 = High ON, 1 = Low ON |
| Power Switch trip | F-95 | 0 = Enable , 1 = Disable |
| Calibration Settings* | | |
| Calibration | F-00 | 0000 ~ 9999 |



*Note

Power On and Calibration settings can only be set during power up.

Normal Function Settings

Output ON Delay Time

Delays turning the output on for a designated amount of time. The Delay indicator will light when the Delay time is not 0.

Note: The Output ON Delay Time setting has a maximum deviation (error) of 20ms.

The Output ON Delay Time setting is disabled when the output is set to external control.

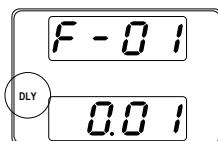

F-01

0.00s~99.99s

Output OFF Delay Time

Delays turning the output off for a designated amount of time. The Delay indicator will light when the Delay time is not 0.

Note: The Output OFF Delay Time setting has a maximum deviation (error) of 20ms.

The Output OFF Delay Time setting is disabled when the output is set to external control.

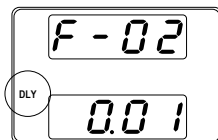

F-02

0.00s~99.99s

V-I Mode

Selects High Speed Priority or Slew Rate Priority for CV or CC mode. The voltage or current slew rate can only be edited if CC/CV Slew Rate Priority is selected. The ISR indicator will be lit for CC Slew Rate Priority and the VSR indicator will be lit for CV Slew Rate Priority.

Note: CC and CV Slew Rate Priority mode are disabled when voltage/current output is set to external control.

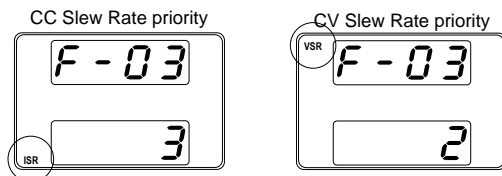

F-03

- 0 = CV high speed priority
- 1 = CC high speed priority
- 2 = CV slew rate priority
- 3 = CC slew rate priority

Rising Voltage Slew Rate

Sets the rising voltage slew rate. Only applicable if V-I Mode is set to CV Slew Rate Priority.

F-04

- 0.01V/s~60V/s (PSW 30-XX)
- 0.1V/s~160V/s (PSW 80-XX)
- 0.1V/s~320V/s (PSW 160-XX)

Falling Voltage Slew Rate

Sets the falling voltage slew rate. Only applicable if V-I Mode is set to CV Slew Rate Priority.

F-05

- 0.01V/s~60V/s (PSW 30-XX)
- 0.1V/s~160V/s (PSW 80-XX)
- 0.1V/s~320V/s (PSW 160-XX)

| | |
|------------------------------|---|
| Rising Current Slew Rate | Sets the rising current slew rate. Only applicable if V-I Mode is set to CC Slew Rate Priority. |
| F-06 | 0.01A/s~72.00A/s (PSW 30-36) 0.1A/s~144.0A/s (PSW 30-72) 0.1A/s~216.0A/s (PSW 30-108) 0.01A/s~27.00A/s (PSW 80-13.5) 0.01A/s~54.00A/s (PSW 80-27) 0.01A/s~81.00A/s (PSW 80-40.5) 0.01A/s~14.40A/s (PSW 160-7.2) 0.01A/s~28.80A/s (PSW 160-14.4) 0.01A/s~43.20A/s (PSW 160-21.6) |
| Falling Current Slew Rate | Sets the falling current slew rate. Only applicable if V-I Mode is set to CC Slew Rate Priority. |
| F-07 | 0.01A/s~72.00A/s (PSW 30-36) 0.1A/s~144.0A/s (PSW 30-72) 0.1A/s~216.0A/s (PSW 30-108) 0.01A/s~27.00A/s (PSW 80-13.5) 0.01A/s~54.00A/s (PSW 80-27) 0.01A/s~81.00A/s (PSW 80-40.5) 0.01A/s~14.40A/s (PSW 160-7.2) 0.01A/s~28.80A/s (PSW 160-14.4) 0.01A/s~43.20A/s (PSW 160-21.6) |
| Internal Resistance Settings | Sets the internal resistance of the power supply. |
| F-08 | 0.000Ω ~0.833Ω (PSW 30-36) 0.000Ω ~0.417Ω (PSW 30-72) 0.000Ω ~0.278Ω (PSW 30-108) 0.000Ω ~5.926Ω (PSW 80-13.5) 0.000Ω ~2.963Ω (PSW 80-27) 0.000Ω ~1.975Ω (PSW 80-40.5) 0.000Ω ~22.222Ω (PSW 160-7.2) 0.000Ω ~11.111Ω (PSW 160-14.4) 0.000Ω ~7.407Ω (PSW 160-21.6) |

| | |
|-----------------|---|
| Bleeder Control | Bleeder control turns ON/OFF the bleeder resistor. Bleeder resistors discharge the filter capacitors after power is turned off as a safety measure. |
| F-09 | 0 = OFF, 1 = ON |

| | |
|---------------|---|
| Buzzer ON/OFF | Turns the buzzer sound on or off. The buzzer is associated with alarm sounds and keypad entry sounds. |
| F-10 | 0 = ON, 1 = OFF |

LAN Settings

| | |
|-------------------|---|
| MAC Address-1~6 | Displays the MAC address 1~6. This setting is not configurable. F-30~F-35 0x00~0xFF |
| LAN | Turns Ethernet on or off. F-36 0 = Disable, 1 = Enable |
| DHCP | Turns DHCP on or off. F-37 0 = Disable, 1 = Enable |
| IP Address-1~4 | Sets the default IP address. IP address 1~4 splits the IP address into four sections. (F-39 : F-40 : F-41 : F-42) (0~255 : 0~255 : 0~255 : 0~255) |
| Subnet Mask 1~4 | Sets the subnet mask. The subnet mask is split into four parts. (F-43 : F-44 : F-45: F-46) (0~255 : 0~255 : 0~255 : 0~255) |
| Gateway 1~4 | Sets the gateway address. The gateway address is split into 4 parts. (F-47 : F-48 : F-49 : F-50) (0~255 : 0~255 : 0~255 : 0~255) |
| DNS Address 1~4 | Sets the DNS address. The DNS address is split into 4 parts. (F-51 : F-52 : F-53 : F-54) (0~255 : 0~255 : 0~255 : 0~255) |
| Sockets active | Enables WebSocket connections. F-57 0 = Disable, 1 = Enable |
| Web server active | Turns Web server control on/off. F-59 0 = Disable, 1 = Enable |

| | | |
|---------------------|--------------------------------------|-------------------------|
| Web Password active | Turns a web password on/off. F-60 | 0 = Disable, 1 = Enable |
| Web Password | Sets the Web password. F-61 | 0000 ~ 9999 |

System Settings

| | | |
|-------------------|--|--|
| Factory Set Value | Returns the PSW to the factory default settings. See page 139 for a list of the default settings. F-88 | 0 = Disable, 1 = Return to factory default settings. |
| Show Version | Displays the PSW version number, build date, keyboard version, analog-control version, kernel build, test command version and test command build date. F-89 | <p>0, 1 = PSW version 2, 3 = PSW build year 4, 5 = PSW build month/day 6, 7 = Keyboard CPLD version 8, 9 = Analog-Control CPLD version A, B = Reserved C, D = Kernel build year E, F = Kernel build month/day G, H = Test command version I, J = Test command build year K, L = Test command build month/day</p> |

Power On Configuration Settings

CV Control Sets the constant voltage (CV) control mode between local and external voltage/resistance control. For external voltage control, see page 104 (External Voltage Control of Voltage Output) and page 109 (External Resistance Control of Voltage Output).

F-90 0= Panel control (local)
 1 = External voltage control
 2 = External resistance control
 (Ext-R \leq 10k Ω = $V_{o,max}$)
 3 = External resistance control
 (Ext-R \geq 10k Ω = 0)

CC Control Sets the constant current (CC) control mode between local and external voltage/resistance control. For details on external voltage control, see page 107 (External Voltage Control of Current Output) and 111 (External Resistance Control of Current Output).

F-91 0= Panel control (local)
 1 = External voltage control
 2 = External resistance control
 (Ext-R \leq 10k Ω = $I_{o,max}$)
 3 = External resistance control
 (Ext-R \geq 10k Ω = 0)

Power-ON Output Sets the power supply to turn the output on or off at power up.

F-92 0 = OFF at startup, 1 = On at start up

Master/Slave Sets the power supply as master or slave. See the parallel/series operation for details, page 62.

| | | |
|--------------------|--|--|
| | F-93 | 0 = Master/Local 1 = Master/Parallel1 2 = Master/Parallel2 3 = Slave/Parallel 4 = Slave/Series |
| External Out Logic | Sets the external logic as active high or low. F-94 | 0= High ON, 1 = Low ON |
| Power Switch Trip | Turns the power off if enabled when the protection settings are tripped. F-95 | 1 = Disable, 0 = Enable |

Calibration

| | | |
|--------------------------|---|-------------|
| Programmable Calibration | The calibration password is used to access the local mode calibration or other special functions. The password used determines which function is accessed. Please see your distributor for details. F-00 | 0000 ~ 9999 |
|--------------------------|---|-------------|

Setting Normal Function Settings

The normal function settings (F-01~F-61, F-88~F-89) can be easily configured with the Function key.

- Ensure the load is not connected.
- Ensure the output is off.



Note

Function setting F-89 (Show Version) can only be viewed, not edited.

Configuration settings F-90~F-95 cannot be edited in the Normal Function Settings. Use the Power On Configuration Settings. See page 99 for details.

Steps

1. Press the Function key. The function key will light up.

Function



2. The display will show F-01 on the top and the configuration setting for F-01 on the bottom.

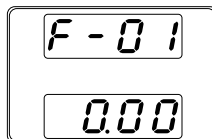

3. Rotate the voltage knob to change the F setting.

Range F-00~ F-61, F-88~F-89

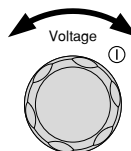

4. Use the current knob to set the parameter for the chosen F setting.

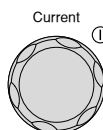

5. Press the Voltage knob to save the configuration setting. ConF will be displayed when successful.

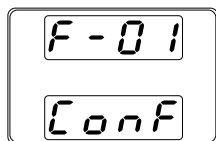
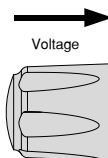

Exit

Press the Function key again to exit the configuration settings. The function key light will turn off.

Function



Setting Power On Configuration Settings

Background

The Power On configuration settings can only be changed during power up to prevent the configuration settings being inadvertently changed.

- Ensure the load is not connected.
- Ensure the power supply is off.

Steps

1. Hold the Function key whilst turning the power on.
2. The display will show F-90 on the top and the configuration setting for F-90 on the bottom.

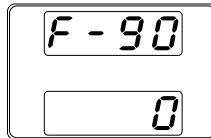
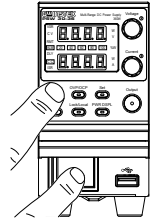

3. Rotate the voltage knob to change the F setting.

Range F-90~ F-95

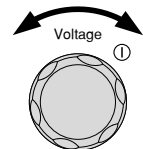

4. Use the current knob to set the parameter for the chosen F setting.

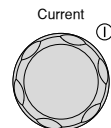

- 5. Press the Voltage knob to save the configuration setting. ConF will be displayed when successful.

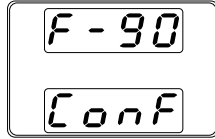
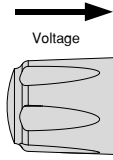

Exit

Cycle the power to save and exit the configuration settings.

A ANALOG CONTROL

The Analog Control chapter describes how to control the voltage or current output using an external voltage or resistance, monitor the voltage or current output as well as remotely turning off the output or shutting down the power supply.

| | |
|---|------------|
| Analog Remote Control Overview | 102 |
| Analog Control Connector Overview | 102 |
| External Voltage Control of Voltage Output | 104 |
| External Voltage Control of Current Output | 107 |
| External Resistance Control of Voltage Output..... | 109 |
| External Resistance Control of Current Output | 111 |
| External Control of Output | 113 |
| External control of Shutdown | 116 |
| | |
| Remote Monitoring | 118 |
| External Voltage and Current Monitoring | 118 |
| External Operation and Status Monitoring..... | 120 |

Analog Remote Control Overview

The PSW power supply series have a number of analog control options. The Analog Control connectors are used to control output voltage and current using external voltage or resistance. The power supply output and power switch can also be controlled using external switches.

- Analog Control connector overview → from page 102
- External voltage control of voltage output → from page 104
- External voltage control of current output → from page 107
- External resistance control of voltage output → from page 109
- External resistance control of current output → from page 111
- External control of output → from page 113
- External control of the power switch → from page 116

Analog Control Connector Overview

Overview The Analog Control Connector is a standard Mil 26 pin connector (OMRON XG4 IDC plug). The connector is used for all analog remote control. The pins used determine what remote control mode is used.

 **WARNING** To prevent electric shock, ensure that the cover for the Analog Control Connector is used when the connector is not in use.

Pin Assignment

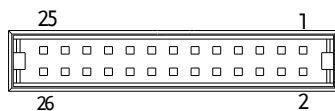

| Pin name | Pin number | Description |
|---------------|------------|--|
| Current Share | 1 | Used when operating 2 or more units in parallel. |

| | | |
|--------------------|----|---|
| D COM | 2 | Connected to the (-S) sense- terminal when remote sense is used. Connected to the negative output terminal when remote sense is not used. |
| CURRENT SUM OUT | 3 | Current sum output signal when used in parallel mode. |
| EXT-V CV CONT | 4 | External voltage control of the voltage output. A voltage of 0~10V is used to control the full scale voltage output (0%~100%) of the instrument. |
| EXT-V CC CONT | 5 | External voltage control of the current output. A voltage of 0~10V is used to control the full scale current output (0%~100%) of the instrument |
| EXT-R CV CONT PIN1 | 6 | External resistance control of the voltage output. A resistance of 0k Ω ~ 10k Ω is used to control the full scale voltage output (0%~100%) of the instrument. |
| EXT-R CV CONT PIN2 | 7 | External resistance control of the voltage output. A resistance of 0k Ω ~ 10k Ω is used to control the full scale voltage output (0%~100%) of the instrument. |
| EXT-R CC CONT PIN1 | 8 | External resistance control of the current output. A resistance of 0k Ω ~ 10k Ω is used to control the full scale current output (0%~100%) of the instrument. |
| EXT-R CC CONT PIN2 | 9 | External resistance control of the current output. A resistance of 0k Ω ~ 10k Ω is used to control the full scale current output (0%~100%) of the instrument. |
| V MON | 10 | Voltage Monitor Output. Outputs the full scale voltage (0~100%) as a voltage (0V~10V). |
| I MON | 11 | Current Monitor Output. Outputs the full scale current (0~100%) as a voltage (0V~10V). |
| SHUTDOWN | 12 | The shut down signal will turn off the output or power when a low TTL signal is applied. The shutdown signal is pulled up to 5V with a 10k Ω pull-up resistor. |
| CURRENT_SUM_1 | 13 | Master unit current sum input signal from first slave CURRENT SUM OUTPUT. Used in parallel mode only. |
| CURRENT_SUM_2 | 14 | Master unit current sum input signal from second slave CURRENT SUM OUTPUT. Used in parallel mode only. |
| FEEDBACK | 15 | Parallel control signal during master-slave parallel operation. |

| | | |
|------------------|----|---|
| A COM | 16 | Analog signal common. Connected to the sense-terminal when remote sense is used. Connected to the negative output terminal when remote sense is not used. |
| STATUS COM | 17 | Common for status signals 18, 19, 20, 21 and 22. |
| CV STATUS | 18 | Turns on when CV mode is active. (photo coupled open collector output) |
| CC STATUS | 19 | Turns on when CC mode is active. (photo coupled open collector output) |
| ALM STATUS | 20 | Turns on when any of the protection modes are tripped (OVP, OCP) or if a shutdown signal is input. (photo coupled open collector output) |
| OUTPUT ON STATUS | 21 | Turns on when the output has been turned on. (photo coupled open collector output) |
| POWER OFF STATUS | 22 | Turns on when the power switch is turned off. |
| N.C. | 23 | Not connected |
| OUT ON/OFF CONT | 24 | Turns the output on/off when (default setting) a low TTL signal is applied. Internally, the circuit is pulled up to +5V with 10kΩ resistance. |
| SER SLV IN | 25 | Series slave input during master-slave series operation. |
| N.C. | 26 | Not connected |

External Voltage Control of Voltage Output

Background External voltage control of the voltage output is accomplished using the MIL-26 connector on the rear panel. A voltage of 0~10V is used to control the full scale voltage of the instrument, where:

$$\text{Output voltage} = \text{full scale voltage} \times (\text{external voltage}/10)$$

Connection

When connecting the external voltage source to the MIL connectors, use shielded or twisted paired wiring.

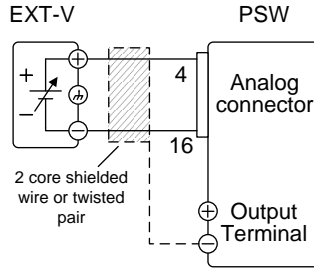

- Pin16 → EXT-V (-)
- Pin4 → EXT-V (+)
- Wire shield → negative (-) output terminal

Connection- alt. shielding

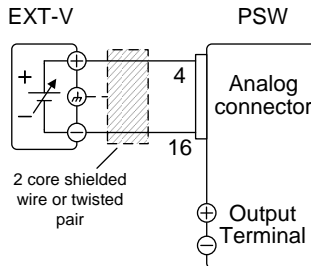

If the wire shield needs to be grounded at the voltage source (EXT-V), then the shield cannot also be grounded at the negative (-) terminal output of the PSW power supply. This would short the output.



- Pin16 → EXT-V(-)
- Pin4 → EXT-V(+)
- Wire shield → EXT-V ground (GND)

Panel operation

1. Connect the external voltage according to the connection diagrams above.

2. Set the F-90 power on configuration setting to 1 (CV control - Ext voltage).
 - Be sure to cycle the power after the power on configuration has been set.
 3. Press the Function key and confirm the new configuration settings (F-90=1).  Function
 4. Press the Output key. The voltage can now be controlled with the External voltage.  Output
-



Note

The input impedance for external voltage control is 10k Ω .

Use a stable voltage supply for the external voltage control.



Note

CV and CC Slew Rate Priority are disabled for V-I mode (F-03) when using external voltage control. See the normal function settings on page 89.



CAUTION

Ensure no more than 10.5 volts are input into the external voltage input.

Ensure the voltage polarity is correct when connecting the external voltage.

External Voltage Control of Current Output

Background External voltage control of the current output is accomplished using the MIL-26 connector on the rear panel. A voltage of 0~10V is used to control the full scale current of the instrument, where:

$$\text{Output current} = \text{full scale current} \times (\text{external voltage}/10)$$

Connection When connecting the external voltage source to the MIL connectors, use shielded or twisted paired wiring.

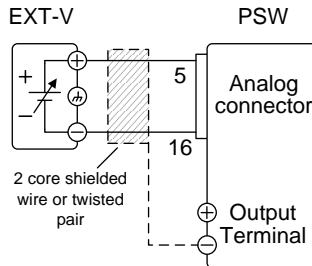

- Pin16 → EXT-V (-)
 - Pin5 → EXT-V (+)
 - Wire shield → negative (-) output terminal
-

Connection- alt. shielding

If the wire shield needs to be grounded at the voltage source (EXT-V), then the shield cannot also be grounded at the negative (-) terminal output of the PSW power supply. This would short the output.

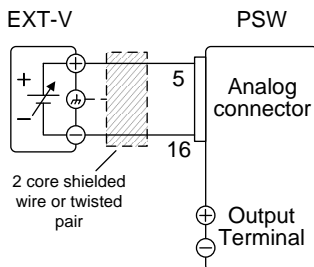

- Pin16 → EXT-V (-)
- Pin5 → EXT-V (+)
- Wire shield → EXT-V ground (GND)

Steps

1. Connect the external voltage according to the connection diagrams above.
2. Set the F-91 power on configuration setting to 1 (CC control - Ext voltage).
 - Be sure to cycle the power after the power on configuration has been set.
3. Press the Function key and confirm the new configuration settings (F-91=1).

Page 99
 Function

4. Press the Output key. The current can now be controlled with the External voltage.

Output



Note

The input impedance for external voltage control is 10k Ω .

Use a stable voltage supply for the external voltage control.



Note

CV and CC Slew Rate Priority are disabled for V-I mode (F-03) when using external voltage control. See the normal function settings on page 89.



CAUTION

Ensure the voltage polarity is correct when connecting the external voltage.

Ensure no more than 10.5 volts are input into the external voltage input.

External Resistance Control of Voltage Output

Background

External resistance control of the voltage output is accomplished using the MIL-26 connector on the rear panel. A resistance of 0k Ω ~10k Ω is used to control the full scale voltage of the instrument.

The output voltage (0 to full scale) can be controlled with the external resistance going up (Ext-R \swarrow) 0k Ω ~10k Ω (10k Ω = $V_{o,max}$) or down (Ext-R \searrow) 10k Ω ~0k Ω (10k Ω = 0).

For 0k Ω ~10k Ω : Output voltage = full scale voltage \times (external resistance/10)

For 10k Ω ~0k Ω : Output voltage = full scale voltage \times ([10-external resistance]/10)



Note

The Ext-R ∇ configuration is recommended for safety reasons. In the event that the cables become accidentally disconnected, the voltage output will drop to zero. Under similar circumstances using Ext-R \sphericalangle , an unexpected high voltage would be output.

If switches are used to switch between fixed resistances, use switches that avoid creating open circuits. Use short-circuit or continuous resistance switches.

Connection

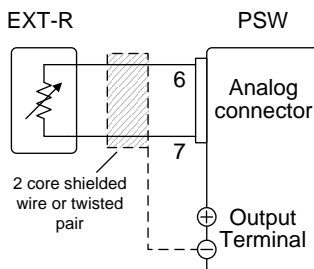

- Pin6 → EXT-R
- Pin7 → EXT-R
- Wire shield → negative (-) output terminal

Steps

1. Connect the external resistance according to the connection diagrams above.
2. Set the F-90 (CV Control) Page 99 configuration settings to 2 for Ext-R \sphericalangle or 3 for Ext-R ∇ .
 - Be sure to cycle the power after the power on configuration has been set.
3. Press the Function key and confirm the new configuration settings (F-90=2 or 3). Function



4. Press the Output key. The voltage can now be controlled with the External resistance.

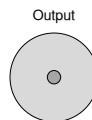

Note

Ensure the resistor(s) and cables used exceed the isolation voltage of the power supply. For example: insulation tubes with a withstand voltage higher than the power supply can be used.

When choosing an external resistor ensure the resistor can withstand a high degree of heat.



Note

CV and CC Slew Rate Priority are disabled for V-I mode (F-03) when using external resistance control. See the normal function settings on page 89.

External Resistance Control of Current Output

Background

External resistance control of the current output is accomplished using the MIL-26 connector on the rear panel. A resistance of $0\text{k}\Omega\sim 10\text{k}\Omega$ is used to control the full scale current of the instrument.

The output current (0 to full scale) can be controlled with the external resistance going up (Ext-R \swarrow) $0\text{k}\Omega\sim 10\text{k}\Omega$ ($10\text{k}\Omega = V_o, \text{max}$) or down (Ext-R \searrow) $10\text{k}\Omega\sim 0\text{k}\Omega$ ($10\text{k}\Omega = 0$).

For $0\text{k}\Omega\sim 10\text{k}\Omega$: Output current = full scale current \times (external resistance/10)

For $10\text{k}\Omega\sim 0\text{k}\Omega$: Output current = full scale current \times ([10-external resistance]/10)



Note

The Ext-R ∇ configuration is recommended for safety reasons. In the event that the cables become accidentally disconnected, the current output will drop to zero. Under similar circumstances using Ext-R \sloperight , an unexpected high current would be output.

If switches are used to switch between fixed resistances, use switches that avoid creating open circuits. Use short-circuit or continuous resistance switches.

Connection

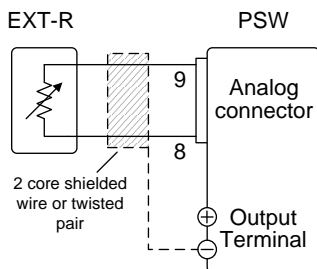

- Pin9 → EXT-R
- Pin8 → EXT-R
- Wire shield → negative (-) output terminal

Steps

1. Connect the external resistance according to the connection diagrams above.
1. Set the F-91 (CC Control) Page 99
configuration settings to 2 for Ext-R \sloperight or 3 for Ext-R ∇ .
 - Be sure to cycle the power after the power on configuration has been set.
2. Press the Function key and confirm the new configuration settings (F-91=2 or 3). Function 

3. Press the Output key. The current can now be controlled with the External resistance.

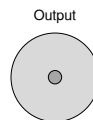

Ensure the resistor(s) and cables used exceed the isolation voltage of the power supply. For example: insulation tubes with a withstand voltage higher than the power supply can be used.

When choosing an external resistor ensure the resistor can withstand a high degree of heat.



CV and CC Slew Rate Priority are disabled for V-I mode (F-03) when using external resistance control. See the normal function settings on page 89.

External Control of Output

Background

The output can be turned on or off externally using a switch. The analog control connector can be set to turn the output on from a high or low signal. The voltage across pins 2 and 24 are internally pulled to +5V $\pm 5\%$ @ 500 μ A with 10k Ω pull-up resistor. A short (closed switch) produces a low signal.

When set to High = On, the output is turned on when the pins 2-24 are open.

When Low = On, the output is turned on when pins 2-24 are shorted.

Connection

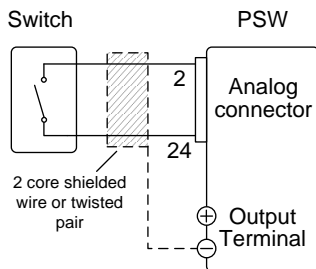

- Pin2 → Switch
- Pin24 → Switch
- Wire shield → negative (-) output terminal

Steps

1. Connect the external switch according to the connection diagrams above.

Set F-94 (External output logic) in Page 99 the power on configuration settings to 0 (High = On) or 1 (Low = On).

- Be sure to cycle the power after setting the power on configuration settings.

2. Press the Function key and confirm the new configuration settings.



3. The switch is now ready to set the output on or off.

 Note

When using a switch over long distances, please use a switch relay to extend the line from the coil side of the relay.

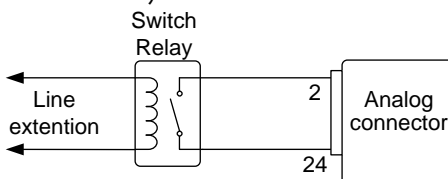

If a single switch control is to be used for multiple units, please isolate each instrument. This can be achieved by using a relay.

 Warning

Ensure the cables used and the switch exceed the isolation voltage of the power supply. For example: insulation tubes with a withstand voltage higher than the power supply can be used.

 Note

Messages: If F-94 = 0 (High = on) and the pin 24 is low (0) "MSG 001" will be displayed on the display.

If F-94 = 1 (Low = on) and the pin 24 is high (1) "MSG 002" will be displayed on the display.

Output off (High=on)

Output off (Low=on)

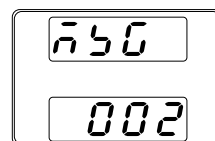
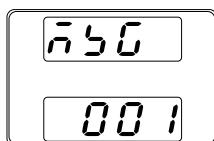

 Note

Output ON/OFF Delay Time (F-01, F-02) are disabled when the output is set to external control. See the normal function settings on 89 for details.

External control of Shutdown

Background The output of the power supplies can be configured to shut down via an external switch. The ability to externally shut down the power supply must first be enabled in the power on configuration settings. The voltage across pins 2 and 12 are internally pulled to +5V \pm 5% @ 500uA with 10k Ω pull-up resistor.

Connection

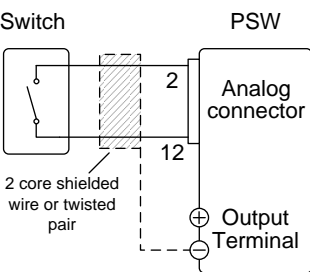

- Pin2 → Switch
- Pin12 → Switch
- Wire shield → negative (-) output terminal

- Steps**
1. Connect the external switches according to the connection diagrams above.
 2. Set F-95 to in the configuration settings to 0 (Enable). This will allow the external control of shutdown. Page 99
 3. Press the function key and confirm the new configuration settings. Function
- 
4. The switch will now shut down the power supply when shorted.



Note

When using a switch over long distances, please use a switch relay to extend the line from the coil side of the relay.

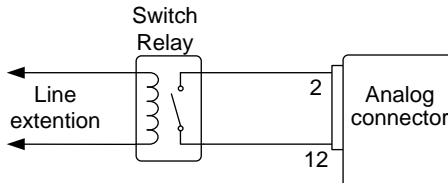

If a single switch control is to be used for multiple units, please isolate each instrument. This can be achieved by using a relay.



Warning

Ensure the cables and switch used exceed the isolation voltage of the power supply. For example: insulation tubes with a withstand voltage higher than the power supply can be used.

Remote Monitoring

The PSW power supplies have remote monitoring support for current and voltage output. They also support monitoring of operation and alarm status.

- External monitoring of output voltage and current → from page 118
- External monitoring of operation mode and alarm status → from page 120

External Voltage and Current Monitoring

Background

The MIL 26 pin connector is used to monitor the current (IMON) or voltage (VMON) output.

An output of 0~10V represents the voltage or current output of 0~ rated current/voltage output.

- $IMON = (\text{current output} / \text{full scale}) \times 10$
- $VMON = (\text{voltage output} / \text{full scale}) \times 10$

External voltage and current monitoring doesn't need to be enabled in the configuration settings.

VMON
Connection

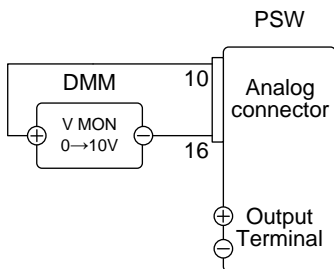

- Pin16 → Neg (-)
- Pin10 → Pos (+)

IMON
Connection

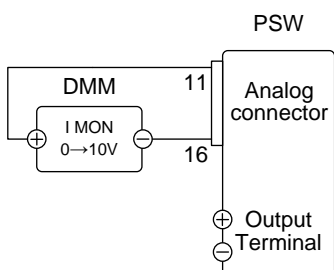

- Pin16 → Neg (-)
- Pin11 → Pos (+)

 **Note**

The output impedance of the voltage (VMON) and current (IMON) monitor pins is 1kΩ.

Maximum current is 10mA.

The monitor outputs are strictly DC and should not be used to monitor analog components such as transient voltage response or ripple etc.

 **CAUTION**

Ensure IMON(pin 11) and VMON(pin 10) are not shorted together. This will cause damage to the unit.

External Operation and Status Monitoring

Background

The MIL 26 pin connector can also be used to monitor the status operation and alarm status of the instrument.

The pins are isolated from the power supply internal circuitry by photo couplers. Status Com (Pin 17) is a photo coupler emitter output, whilst pins 18~22 are photo coupler collector outputs.

A maximum of 30V and 8mA can be applied to each pin.

| Name and Pin | Description |
|-------------------|--|
| STATUS COM 17 | Common (photo coupler emitter) for status signals 18, 19, 20, 21 and 22. |
| CV STATUS 18 | Low when CV mode is active. |
| CC STATUS 19 | Low when CC mode is active. |
| ALM STATUS 20 | Low when any of the protection modes are tripped (OVP, OCP). Active low. |
| OUT ON STATUS 21 | Low when the output is on. |
| PWR OFF STATUS 22 | Active low. |

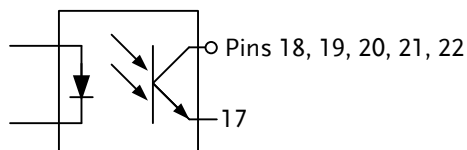

Timing diagrams Below are 4 example timing diagrams covering a number of scenarios. Note that pins 18~22 are all active low.

CV MODE:
Output turned on The diagram below shows the timing diagram when the output is turned on when the PSW is set to CV mode.

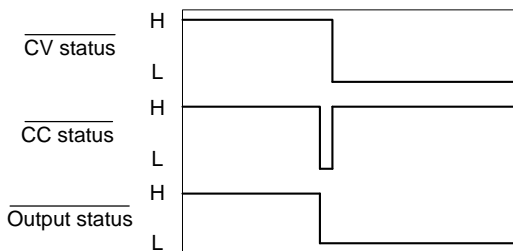

CV MODE:
Output turned off The diagram below shows the output status lines when the output is turned off in CV mode.

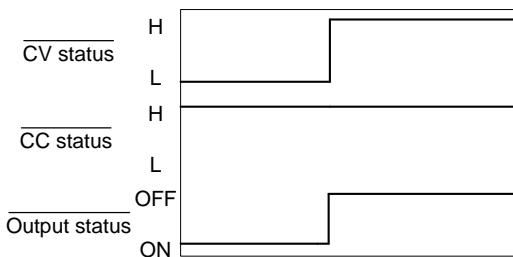

CC MODE: The diagram below shows the timing diagram when the output is turned on when the PSW is set to CC mode.
Output turned on

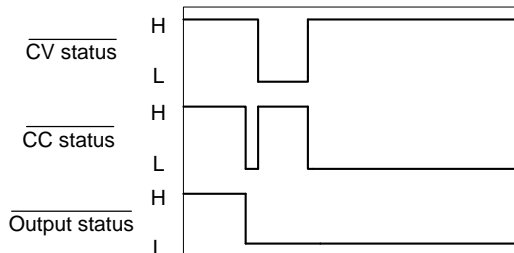

CC MODE: The diagram below shows the output status lines when the output is turned off in CC mode.
Output turned off

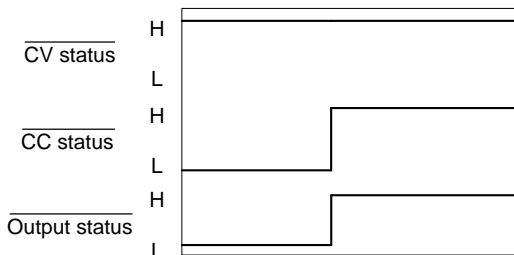

C

COMMUNICATION

INTERFACE

This chapter describes basic configuration of IEEE488.2 based remote control. For a command list, refer to the programming manual, downloadable from GW Instek website, www.gwinstek.com

| | |
|--|------------|
| Interface Configuration | 124 |
| USB Remote Interface | 124 |
| Configure GPIB Interface | 124 |
| Configure Ethernet Connection | 126 |
| Web Server Configuration | 126 |
| Sockets Server Configuration | 127 |
| USB Remote Control Function Check | 128 |
| Web Server Remote Control Function Check | 129 |

Interface Configuration

USB Remote Interface

| | | |
|-------------------|--------------------|-----------------------------------|
| USB configuration | PC side connector | Type A, host |
| | PSW side connector | Rear panel Type B, slave |
| | Speed | 1.1/2.0 (full speed/high speed) |
| | USB Class | CDC (communications device class) |

Steps

1. Connect the USB cable to the rear panel USB B port.

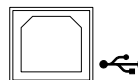

2. Change the Rear panel-USB (F-22) Page 97 setting to USB-CDC (2).

Configure GPIB Interface

To use GPIB, the optional GPIB to USB (GUG-001) adapter must be used. Only one GPIB address can be used at a time.

Configure GPIB

1. Ensure the PSW is off before proceeding.
2. Connect the USB cable from the rear panel USB B port on the PSW to the USB A port on the GPIB to USB adapter.
3. Connect a GPIB cable from a GPIB controller to the GPIB port on the adapter.

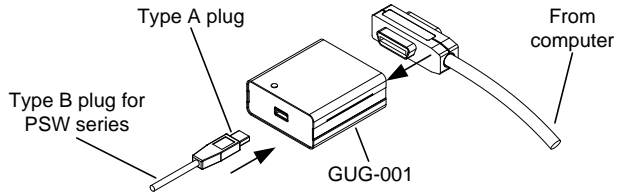

4. Turn the PSW on.
5. Press the Function key to enter the Page 97 Normal configuration settings.

Set the following GPIB settings

- | | |
|-------------|---|
| F-22 = 1 | Set the rear panel USB port to GPIB-USB (GUG-001) |
| F-23 = 0~30 | Set the GPIB address (0~30) |

-
- GPIB constraints
- Maximum 15 devices altogether, 20m cable length, 2m between each device
 - Unique address assigned to each device
 - At least 2/3 of the devices turned On
 - No loop or parallel connection

Configure Ethernet Connection

The Ethernet interface can be configured for a number of different applications. Ethernet can be configured for basic remote control or monitoring using a web server or it can be configured as a socket server.

The PSW series supports both DHCP connections so the instrument can be automatically connected to an existing network or alternatively, network settings can be manually configured.

| | | |
|-----------------------------------|---|--------------------------|
| Ethernet configuration Parameters | For details on how to configure the Ethernet settings, please see the configuration chapter on page 94. | |
| | MAC Address (display only) | LAN |
| | DHCP | IP Address |
| | Subnet Mask | Gateway |
| | DNS Address | Sockets Active |
| | Web Server Active | Web Password Active |
| | Web set password | 0000~9999 (default 0000) |

Web Server Configuration

Configuration This configuration example will configure the PSW as a web server and use DHCP to automatically assign an IP address to the PSW.

1. Connect an Ethernet cable from the network to the rear panel Ethernet port.

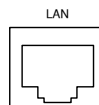

2. Press the Function key to enter the Page 97 Normal configuration settings.

Set the following LAN settings:

| | |
|----------|------------------------|
| F-36 = 1 | Enable LAN |
| F-37 = 1 | Turn DHCP to enable |
| F-59 = 1 | Turn the web server on |

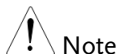

Note

It may be necessary to cycle the power or refresh the web browser to connect to a network.

Sockets Server Configuration

Configuration This configuration example will configure the PSW socket server.

The following configuration settings will manually assign the PSW an IP address and enable the socket server. By default, the socket server port number is 2268 and cannot be configured.

1. Connect an Ethernet cable from the network to the rear panel Ethernet port.

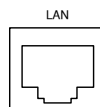

2. Press the Function key to enter the Page 97 Normal configuration settings.

Set the following LAN settings:

| | |
|------------|-------------------------|
| F-36 = 1 | Enable LAN |
| F-37 = 0 | Disable DHCP |
| F-39 = 172 | IP Address part 1 of 4 |
| F-40 = 16 | IP Address part 2 of 4 |
| F-41 = 5 | IP Address part 3 of 4 |
| F-42 = 133 | IP Address part 4 of 4 |
| F-43 = 255 | Subnet Mask part 1 of 4 |
| F-44 = 255 | Subnet Mask part 2 of 4 |

| | |
|------------|-------------------------|
| F-45 = 128 | Subnet Mask part 3 of 4 |
| F-46 = 0 | Subnet Mask part 4 of 4 |
| F-43 = 172 | Gateway part 1 of 4 |
| F-44 = 16 | Gateway part 2 of 4 |
| F-45 = 21 | Gateway part 3 of 4 |
| F-46 = 101 | Gateway part 4 of 4 |
| F-57 = 1 | Enable Sockets |



Note

The socket function is only available for firmware version V1.12 or above. See page 95 to check your firmware version number.

USB Remote Control Function Check

Functionality
check

Invoke a terminal application such as MTTY (Multi-Threaded TTY).

To check the COM port No, see the Device Manager in the PC. For WinXP; Control panel → System → Hardware tab.

Run this query command via the terminal after the instrument has been configured for USB remote control (page 124).

```
*idn?
```

This should return the Manufacturer, Model number, Serial number, and Firmware version in the following format.

```
GW-INSTEK,PSW-3036,TW123456,01.00.20110101
```

```
Manufacturer: GW-INSTEK
Model number : PSW-3036
Serial number : TW123456
Firmware version : 01.00.20110101
```

- ^j can be used as the terminal character when entering the queries/commands from a terminal application.

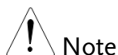

Note

For further details, please see the programming manual, available on the GW Instek web site @ www.gwinstek.com.

Web Server Remote Control Function Check

Functionality
check

Enter the IP address of the power supply in a web browser after the instrument has been configured as a web server (page 126).

`http:// XXX.XXX.XXX.XXX`

The web browser interface appears.



Note

For further details, please see the programming manual, available on the GW Instek web site @ www.gwinstek.com.

Socket Server Function Check

Background

To test the socket server functionality, National Instruments Measurement and Automation Explorer can be used. This program is available on the NI website, www.ni.com, via a search for the VISA Run-time Engine page, or “downloads” at the following URL, <http://www.ni.com/visa/>

Requirements

Firmware: V1.12
Operating System: Windows XP, 7

Functionality

1. Start the NI Measurement and Automation

check

Explorer (MAX) program. Using Windows, press:

Start>All Programs>National Instruments>Measurement & Automation



2. From the Configuration panel access;

My System>Devices and Interfaces>Network Devices

3. Press *Add New Network Device>Visa TCP/IP Resource...*

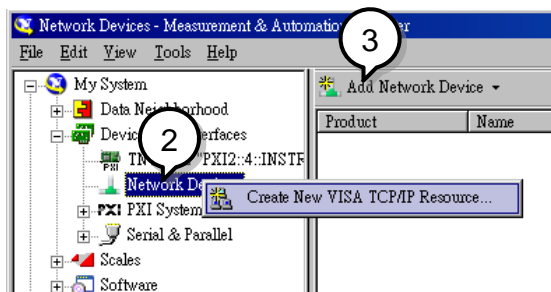

4. Select *Manual Entry of Raw Socket* from the popup window.

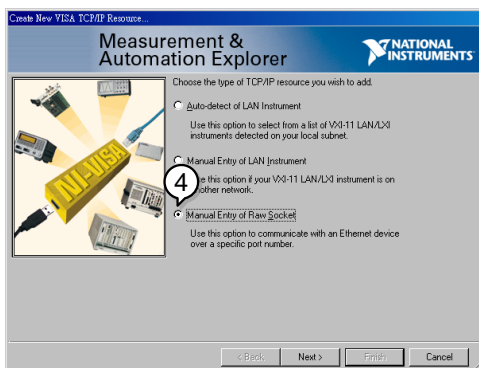

5. Enter the IP address and the port number of the PSW. The port number is fixed at 2268.

6. Double click the Validate button.

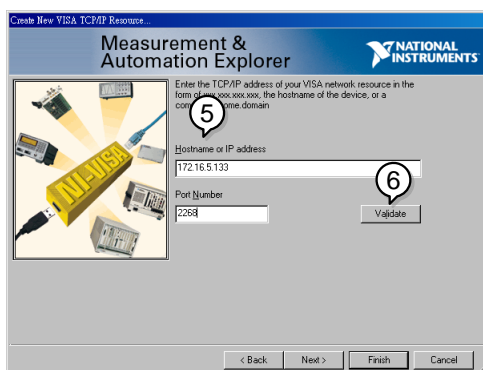

7. Next configure the Alias (name) of the PSW connection. In this example the Alias is: PSW_DC1
8. Click finish.

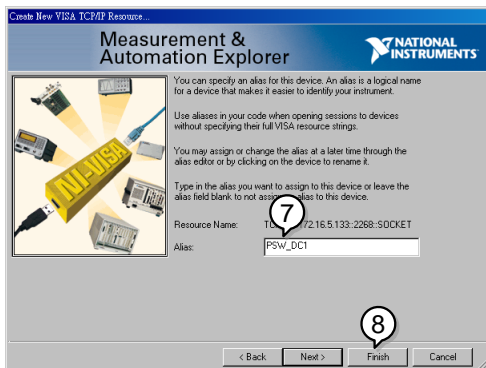

9. The IP address of the PSW will now appear under Network Devices in the configuration panel. Select this icon now.
10. Press *Open VISA Test Panel*.

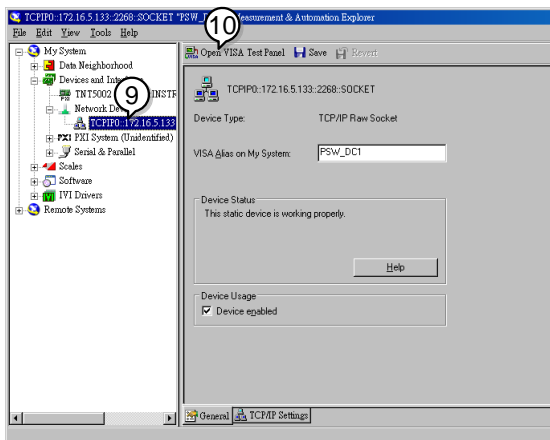

- Under the *Template > Property Node* tabs, set *Termination Char Enable* from the *Attribute Name* list to *VI_TRUE*.

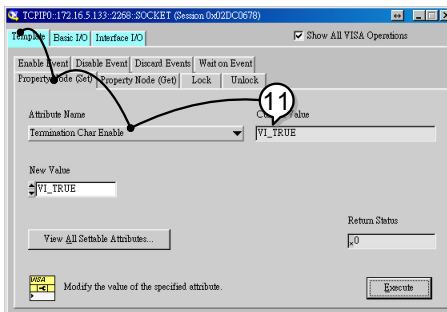

- Under the *Basic I/O > Write* tabs, Enter the **IDN?* query into the *Buffer*, if it is not already there.

- Click the *Execute* button.

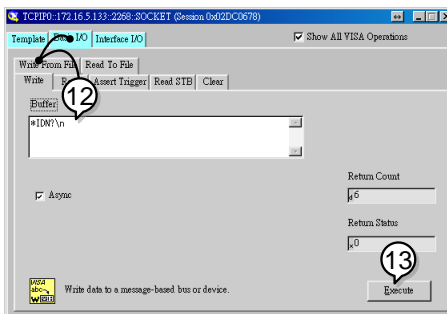

14. In the *Basic I/O > Read* tabs, the return parameter for the *IDN? query should be returned to the buffer area:
 GW-INSTEK,PSW-8013,,T1.12.20111013

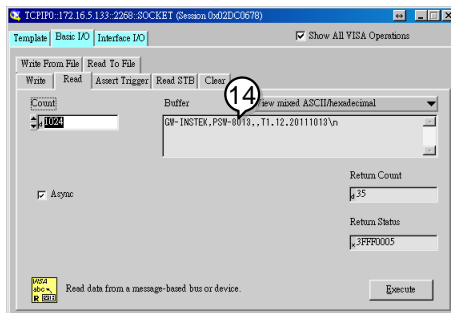

Note

For further details, please see the programming manual, available on the GW Instek web site @ www.gwinstek.com.

M AINTENANCE

The PSW power supply filters should be replaced on a periodic schedule to maintain performance and specification characteristics.

| | |
|---------------------------------|-----|
| Replacing the Dust Filter | 136 |
|---------------------------------|-----|

Replacing the Dust Filter

The dust filter should be replaced at least 2 times a year. Not replacing the filter on a regular basis will reduce performance and may cause the unit to overheat.

Front panel filter (all models)

1. Turn the instrument off.
2. Pull the filter out from the bottom of the front panel.

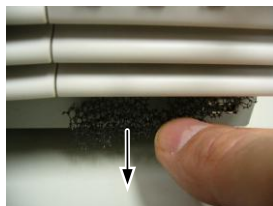

3. Replace the filter with GW Instek part number 57RG-30B00101.

Side panel filters (Type II & Type III)

1. Lift the side panel up and away from the case.

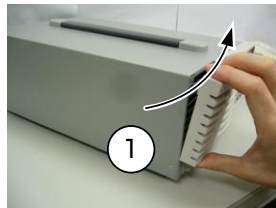

2. Remove the filter from the grill and replace with a new filter (GW Instek part number 57RG-30B00201).

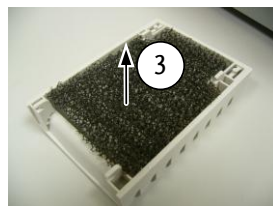

F

FAQ

-
- The power supply won't let me change the mode (C.V. mode ↔ C.C. mode).
 - The OVP voltage is triggered earlier than expected.
 - Can I combine more than 1 cable together for the output wiring?
 - The accuracy does not match the specification.

The power supply won't let me change the mode (C.V. mode ↔ C.C. mode).

To set the power supply to CC or CV mode, the Function key must be held when the power is turned on to enter the Power On Configuration Mode. See page 95.

The OVP voltage is triggered earlier than expected.

When setting the OVP voltage, take into account the voltage drop from the load cables. As the OVP level is set from the output terminals and not the load terminals, the voltage at the load terminals may be slightly lower.

Can I combine more than 1 cable together for the output wiring?

Yes. Cables can be used together (in parallel) if the current capacity of a single cable is insufficient. However the withstand voltage should also be taken into account. Ensure the cables are twisted together and are the same length.

The accuracy does not match the specification.

Make sure the device is powered On for at least 30 minutes, within +20°C~+30°C. This is necessary to stabilize the unit to match the specification.

For more information, contact your local dealer or GWInstek at www.gwinstek.com / marketing@goodwill.com.tw.

A PPENDIX

Firmware Update

Background The PSW firmware can be upgraded using the USB A port on the front panel.



- Ensure the load is not connected.
 - Ensure the output is off.
-

1. Insert a USB Flash Drive into the USB port on front panel of the PSW.
 - The USB drive should include the **gw_psx** and **tcmd.tst** files in the root directory (USB\:).
 - For units with firmware version V 1.12 or below, a folder named “**gw**” must be created (\gw) and the **gw_psx** file should be copied to both the root directory and to the “**gw**” folder before proceeding with the firmware update procedure.
 - For firmware versions after V1.12, only the root directory needs to contain the **gw_psx** file.
2. Press the Function key. The function key will light up.

Function



3. The display will show F-01 on the top and the configuration setting for F-01 on the bottom.



4. Rotate the voltage knob to change the F setting until to F-00 is shown.

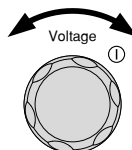

5. The display will show F-00 on the top and the 0000 for the Password for F-00



6. Use the current knob to enter the Password for the F-00 setting. The Password is "5 0 0 4".

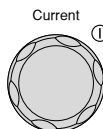

7. Press the Voltage knob to enter the Calibration Mode. SF-1 will be displayed when successful.

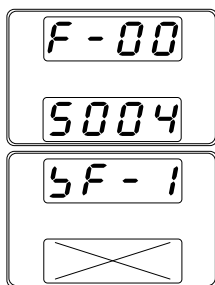
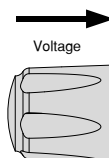

X for don't care

8. Rotate the voltage knob to change the SF setting until to SF-2 is shown.

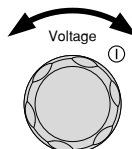

9. The display will show SF-2 on the top.

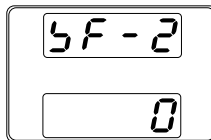

10. Use the current knob to set SF-2 to "1".

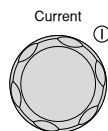

Voltage

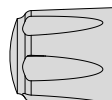

11. Press the Voltage knob to copy the new firmware to the PSW.

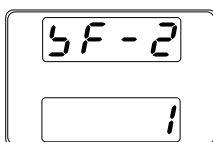

12. During the update, the display will show the following progress bar.

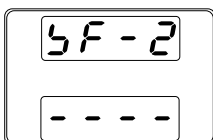
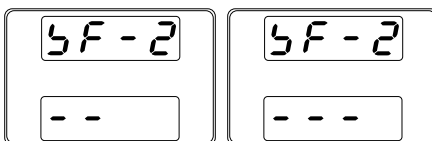
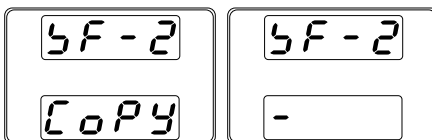

13. After the update has finished, SF-2 ok will be displayed and the system will reboot automatically.

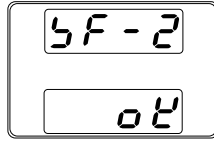

14. To update the tCmd.tst file, the update procedure **MUST** be performed again.

PSW Default Settings

The following default settings are the factory configuration settings for the power supply (Function settings/Test settings).

For details on how to return to the factory default settings, see page 45.

| Initial Settings | Default Setting | |
|---------------------------|-----------------|----------------------------|
| Output | Off | |
| LOCK | 0 (Disabled) | |
| Voltage | 0V | |
| Current | 0A | |
| OVP | Maximum | |
| OCP | Maximum | |
| Normal Function | | |
| Settings | Setting | Default Setting |
| Output ON delay time | F-01 | 0.00s |
| Output OFF delay time | F-02 | 0.00s |
| V-I mode slew rate select | F-03 | 0 = CV high speed priority |
| Rising voltage slew rate | F-04 | 60.00V/s (PSW 30-XX) |
| | | 160.0V/s (PSW 80-XX) |
| | | 320.0V/s (PSW 160-XX) |
| Falling voltage slew rate | F-05 | 60.00V/s (PSW 30-XX) |
| | | 160.0V/s (PSW 80-XX) |
| | | 320.0V/s (PSW 160-XX) |
| Rising current slew rate | F-06 | 72.00A/s (PSW 30-36) |
| | | 144.0A/s (PSW 30-72) |
| | | 216.0A/s (PSW 30-108) |
| | | 27.00A/s (PSW 80-13.5) |
| | | 54.00A/s (PSW 80-27) |
| | | 81.00A/s (PSW 80-40.5) |
| | | 14.40A/s (PSW 160-7.2) |
| 28.80A/s (PSW 160-14.4) | | |
| | | 43.20A/s (PSW 160-21.6) |

| | | |
|---------------------------|------|-------------------------|
| Falling current slew rate | F-07 | 72.00A/s (PSW 30-36) |
| | | 144.0A/s (PSW 30-72) |
| | | 216.0A/s (PSW 30-108) |
| | | 27.00A/s (PSW 80-13.5) |
| | | 54.00A/s (PSW 80-27) |
| | | 81.00A/s (PSW 80-40.5) |
| | | 14.40A/s (PSW 160-7.2) |
| | | 28.80A/s (PSW 160-14.4) |
| 43.20A/s (PSW 160-21.6) | | |

Internal resistance setting F-08 0.000Ω

Bleeder circuit control F-09 1 = ON

Buzzer ON/OFF control F-10 1 = ON

USB/GPIB setting

Rear Panel USB Mode F-22 2 = USB CDC

GPIB address F-23 8

LAN setting

LAN F-36 1 = Enable

DHCP F-37 1 = Enable

Sockets active F-57 1 = Enable

Web Server active F-59 1 = Enable

Web password active F-60 1 = Enable

Web setting password F-61 0000

Power On Configuration

CV Control F-90 0= Panel control (local)

CC Control F-91 0= Panel control (local)

Power-ON Output F-92 0 = OFF at startup

Master/Slave F-93 0 = Master/Local

External Out Logic F-94 0= High ON

Power Switch trip F-95 0 = Enable

Error Messages & Messages

The following error messages or messages may appear on the PSW screen during operation.

| Error Messages | Description |
|----------------|---------------------------------------|
| Err 001 | USB Mass Storage is not present |
| Err 002 | No (such)file in USB mass storage |
| Err 003 | Empty memory location |
| Err 004 | File access error |
| Err 901 | Keyboard CPLD error |
| Err 902 | Analog CPLD error |
| Err 920 | The ADC is over range for calibration |
| Err 921 | The DAC is over range for calibration |
| Err 922 | Point invalid for calibration |

| Messages | Description |
|----------|--|
| MSG 001 | External control of output. Output off (F-94=0, High=on) |
| MSG 002 | External control of output. Output off (F-94=1, Low=on) |
| MSG 003 | F-93 is not zero. Unable to calibrate. |

LED Display Format

Use the following table to read the LED display messages.

| | | | | | | | | | | | | | |
|---|---|---|---|---|---|---|---|---|---|---|---|---|---|
| 0 | 1 | 2 | 3 | 4 | 5 | 6 | 7 | 8 | 9 | A | B | C | D |
| 0 | 1 | 2 | 3 | 4 | 5 | 6 | 7 | 8 | 9 | A | b | C | d |
| E | F | G | H | I | J | K | L | M | N | O | P | Q | R |
| E | F | G | H | I | J | K | L | M | N | O | P | Q | R |
| S | T | U | V | W | X | Y | Z | (|) | + | - | , | |
| S | T | U | V | W | X | Y | Z | (|) | + | - | , | |

PSW Specifications

The specifications apply when the PSW is powered on for at least 30 minutes.

PSW 30-36, PSW 80-13.5, PSW 160-7.2

| Model | | PSW 30-36 | PSW 80-13.5 | PSW 160-7.2 |
|---|----------------------|---|-------------|-------------|
| DC Output Ratings: | Voltage | 30V | 80V | 160V |
| | Current | 36A | 13.5A | 7.2A |
| | Power | 360W | 360W | 360W |
| Load Effect: | Voltage | 0.05% of rating + 5mV | | |
| | Current | 0.1% of rating + 5mA | | |
| Source Effect: (change from 85-132 VAC input or 170-265 VAC input) | | | | |
| | Voltage | 0.05% of rating + 3mV | | |
| | Current | 0.1% of rating + 5mA | | |
| Output Ripple and Noise: (Noise Bandwidth=20MHz, Ripple Bandwidth=1MHz) | | | | |
| | CV p-p | 60mV | 60mV | 60mV |
| | CV rms | 7mV | 7mV | 12mV |
| | CC rms | 72mA | 27mA | 15mA |
| Programming accuracy | Voltage | 0.1% + 10mV | 0.1% + 10mV | 0.1% + 10mV |
| | Current | 0.1% + 30mA | 0.1% + 10mA | 0.1% + 5mA |
| Measurement accuracy | Voltage | 0.1% + 10mV | 0.1% + 10mV | 0.1% + 20mV |
| | Current | 0.1% + 30mA | 0.1% + 10mA | 0.1% + 5mA |
| Load Transient Recovery Time: (time for output voltage to recover within 0.1% + 10mV of its rated output for a load change from 50 to 100% of its rated output current) | | | | |
| | Time | 1ms | 1ms | 2ms |
| Output Response Time: | | | | |
| | Rise time | 50ms | 50ms | 100ms |
| | Fall time, Full load | 50ms | 50ms | 100ms |
| | Fall time, no load | 500ms | 500ms | 1000ms |
| Programming/ Measurement Resolution: | Voltage | 1mV | 2mV | 3mV |
| | Current | (by PC remote control mode) | | |
| | Current | 1mA | 1mA | 1mA |
| | | (by PC remote control mode) | | |
| Series and Parallel Capability | | | | |
| | Parallel operation | Up to 3 units including the master unit | | |
| | Series operation | Up to 2 units including the master unit | | |

| | | |
|--|--|--|
| Temperature Coefficient: (after a 30 minute warm-up) | | |
| Voltage | 100ppm/°C | |
| Current | 200ppm/°C | |
| Protection Function | OVP setting | 10% to 110% of rated output voltage range |
| | OVP accuracy | ±(Rated output voltage x 2%) |
| | OCP setting | 10% to 110% of rated output current range |
| | OCP accuracy | ±(Rated output current x 2%) |
| | OTP | Activated by elevated internal temperatures |
| Analog Programming and monitoring | | |
| EXT-V Control | Accuracy & linearity = +/-0.5% of rated Vout Vo | |
| EXT-V Control | Accuracy & linearity = +/-1% of rated Iout Io | |
| EXT-R Control | Accuracy & linearity = +/-1.5% of rated Vout Vo | |
| EXT-R Control | Accuracy & linearity = +/-1.5% of rated Iout Io | |
| Vo Monitor | Accuracy = 1% | |
| Io Monitor | Accuracy = 1% | |
| Front Panel Display Accuracy: 4 digits | | |
| Voltage | 0.1% ± 2 count 0.1% ± 2 count 0.1% ± 1 count | |
| Current | 0.1% ± 4 count 0.1% ± 2 count 0.1% ± 5 count | |
| Environmental Conditions: | Operating temp. | 0°C to 50°C |
| | Storage temp. | -25°C to 70°C |
| | Operating humidity | 20% to 85% RH; No condensation |
| | Storage humidity | 90% RH or less; No condensation |
| Interface | USB | TypeA: Host, TypeB: Slave, Speed: 1.1/2.0, USB Class: CDC(Communications Device Class) |
| | LAN | MAC Address, DNS IP Address, User Password, Gateway IP Address, Instrument IP Address, Subnet Mask |
| | GPIB | Optional: GUG-001 (GPIB to USB Adapter) |

| | | | | |
|-----------------------|--------------------|--|-------------|-----|
| AC Input: Input | Nominal Input | 100 - 240 VAC; 50/60Hz | | |
| | Input Range | 85VAC ~ 265VAC | | |
| | Frequency | 47Hz ~ 63Hz | | |
| | Hold up Time | > 20ms (at rated load) | | |
| | Input Current | 5A@100VAC / 2.5A@200VAC | | |
| | Power (max) | 500VA | | |
| | Power Factor (typ) | 0.98 | | |
| | Efficiency (typ) | 75% | 78% | 80% |
| | Inrush Current | < 25Apeak | | |
| | General | Weight | Approx. 3kg | |
| Dimensions | | W×H×D = 71×124×350 mm | | |
| Withstand Voltage | | Chassis and output terminal; chassis and AC input; AC input and output terminal: AC 1500V or DC2130V 1 minute. | | |
| Insulation Resistance | | Chassis and output terminal; chassis and AC input; AC input and output terminal: 100MΩ or more (DC 500V) | | |

PSW 30-72, PSW 80-27, PSW 160-14.4

| Model | | PSW 30-72 | PSW 80-27 | PSW 160-14.4 |
|---|----------------------|---|-------------|--------------|
| DC Output Ratings: | Voltage | 30V | 80V | 160V |
| | Current | 72A | 27A | 14.4A |
| | Power | 720W | 720W | 720W |
| Load Effect: | Voltage | 0.05% of rating + 5mV | | |
| | Current | 0.1% of rating + 5mA | | |
| Source Effect: (change from 85-132 VAC input or 170-265 VAC input) | | | | |
| | Voltage | 0.05% of rating + 3mV | | |
| | Current | 0.1% of rating + 5mA | | |
| Output Ripple and Noise: (Noise Bandwidth=20MHz, Ripple Bandwidth=1MHz) | | | | |
| | CV p-p | 80mV | 80mV | 80mV |
| | CV rms | 11mV | 11mV | 15mV |
| | CC rms | 144mA | 54mA | 30mA |
| Programming accuracy | Voltage | 0.1% + 10mV | 0.1% + 10mV | 0.1% + 10mV |
| | Current | 0.1% + 60mA | 0.1% + 30mA | 0.1% + 15mA |
| Measurement accuracy | Voltage | 0.1% + 10mV | 0.1% + 10mV | 0.1% + 10mV |
| | Current | 0.1% + 60mA | 0.1% + 30mA | 0.1% + 15mA |
| Load Transient Recovery Time: (time for output voltage to recover within 0.1% + 10mV of its rated output for a load change from 50 to 100% of its rated output current) | | | | |
| | Time | 1ms | 1ms | 2ms |
| Output Response Time: | | | | |
| | Rise time | 50ms | 50ms | 100ms |
| | Fall time, full load | 50ms | 50ms | 100ms |
| | Fall time, no load | 500ms | 500ms | 1000ms |
| Programming/Measurement Resolution: | Voltage | 1mV | 2mV | 3mV |
| | | (by PC remote control mode) | | |
| | Current | 2mA | 2mA | 2mA |
| | | (by PC remote control mode) | | |
| Series and Parallel Capability | | | | |
| | Parallel operation | Up to 3 units including the master unit | | |
| | Series operation | Up to 2 units including the master unit | | |
| Temperature Coefficient: (after a 30 minute warm-up) | | | | |
| | Voltage | 100ppm/°C | | |
| | Current | 200ppm/°C | | |

| | | | | |
|--|--------------------|--|--------------------|--------------------|
| Protection Function | OVP setting range | 10% to 110% of rated output voltage | | |
| | OVP accuracy | $\pm(\text{Rated output voltage} \times 2\%)$ | | |
| | OCP setting range | 10% to 110% of rated output current | | |
| | OCP accuracy | $\pm(\text{Rated output current} \times 2\%)$ | | |
| | OTP | Activated by elevated internal temperatures | | |
| Analog Programming and monitoring | | | | |
| | EXT-V Control Vo | Accuracy & linearity = $\pm 0.5\%$ of rated Vout | | |
| | EXT-V Control Io | Accuracy & linearity = $\pm 1\%$ of rated Iout | | |
| | EXT-R Control Vo | Accuracy & linearity = $\pm 1.5\%$ of rated Vout | | |
| | EXT-R Control Io | Accuracy & linearity = $\pm 1.5\%$ of rated Iout | | |
| | Vo Monitor | Accuracy = 1% | | |
| | Io Monitor | Accuracy = 1% | | |
| Front Panel Display Accuracy: 4 digits | | | | |
| | Voltage | 0.1% \pm 2 count | 0.1% \pm 2 count | 0.1% \pm 1 count |
| | Current | 0.1% \pm 7 count | 0.1% \pm 4 count | 0.1% \pm 3 count |
| Environmental Conditions: | Operating temp. | 0°C to 50°C | | |
| | Storage temp. | -25°C to 70°C | | |
| | Operating humidity | 20% to 85% RH; No condensation | | |
| | Storage humidity | 90% RH or less; No condensation | | |
| Interface | USB | TypeA: Host, TypeB: Slave, Speed: 1.1/2.0, USB Class: CDC(Communications Device Class) | | |
| | LAN | MAC Address, DNS IP Address, User Password, Gateway IP Address, Instrument IP Address, Subnet Mask | | |
| | GPIB | Optional: GUG-001 (GPIB to USB Adapter) | | |
| AC Input: | Nominal Input | 100 - 240 VAC; 50/60Hz | | |
| | Input Range | 85VAC ~ 265VAC | | |
| | Frequency | 47Hz ~ 63Hz | | |
| | Hold up Time | > 20ms (at rated load) | | |
| | Input Current | 10A@100VAC / 5A@200VAC | | |
| | Power (max) | 1000VA | | |
| | Power Factor (typ) | 0.98 | | |
| | Efficiency (typ) | 75% | 78% | 80% |
| | Inrush Current | < 50Apeak | | |

| | | |
|---------|-----------------------|--|
| General | Weight | Approx. 5kg |
| | Dimensions | W×H×D = 142×124×350 mm |
| | Withstand Voltage | Chassis and output terminal; chassis and AC input; AC input and output terminal: AC 1500V or DC2130V 1 minute. |
| | Insulation Resistance | Chassis and output terminal; chassis and AC input; AC input and output terminal: 100MΩ or more (DC 500V) |
| | | |

PSW 30-108, PSW 80-40.5, PSW 160-21.6

| | | | | |
|---|----------------------|---|-------------|--------------|
| Model | | PSW 30-108 | PSW 80-40.5 | PSW 160-21.6 |
| DC Output | Voltage | 30V | 80V | 160V |
| Ratings: | Current | 108A | 40.5A | 21.6A |
| | Power | 1080W | 1080W | 1080W |
| Load Effect: | Voltage | 0.05% of rating + 5mV | | |
| | Current | 0.1% of rating + 5mA | | |
| Source Effect: (change from 85-132 VAC input or 170-265 VAC input) | | | | |
| | Voltage | 0.05% of rating + 3mV | | |
| | Current | 0.1% of rating + 5mA | | |
| Output Ripple and Noise: (Noise Bandwidth=20MHz, Ripple Bandwidth=1MHz) | | | | |
| | CV p-p | 100mV | 100mV | 100mV |
| | CV rms | 14mV | 14mV | 20mV |
| | CC rms | 216mA | 81mA | 45mA |
| Programming accuracy | Voltage | 0.1% + 10mV | 0.1% + 10mV | 0.1% + 10mV |
| | Current | 0.1% + 100mA | 0.1% + 40mA | 0.1% + 20mA |
| Measurement accuracy | Voltage | 0.1% + 10mV | 0.1% + 10mV | 0.1% + 10mV |
| | Current | 0.1% + 100mA | 0.1% + 40mA | 0.1% + 20mA |
| Load Transient Recovery Time: (time for output voltage to recover within 0.1% + 10mV of its rated output for a load change from 50 to 100% of its rated output current) | | | | |
| | Time | 1ms | 1ms | 2ms |
| Output Response Time: | | | | |
| | Rise time | 50ms | 50ms | 100ms |
| | Fall time, full load | 50ms | 50ms | 100ms |
| | Fall time, no load | 500ms | 500ms | 1000ms |
| Programming/ Measurement Resolution: | Voltage | 1mV (by PC remote control mode) | 2mV | 3mV |
| | Current | 3mA (by PC remote control mode) | 3mA | 3mA |
| Series and Parallel Capability | | | | |
| | Parallel operation | Up to 3 units including the master unit | | |
| | Series operation | Up to 2 units including the master unit | | |
| Temperature Coefficient: (after a 30 minute warm-up) | | | | |
| | Voltage | 100ppm/°C | | |
| | Current | 200ppm/°C | | |

| | | | | |
|--|--------------------|--|--------------------|--------------------|
| Protection Function | OVP setting | 10% to 110% of rated output voltage range | | |
| | OVP accuracy | $\pm(\text{Rated output voltage} \times 2\%)$ | | |
| | OCP setting | 10% to 110% of rated output current range | | |
| | OCP accuracy | $\pm(\text{Rated output current} \times 2\%)$ | | |
| | OTP | Activated by elevated internal temperatures | | |
| Analog Programming and Monitoring | | | | |
| EXT-V Control | Vo | Accuracy & linearity = $\pm 0.5\%$ of rated Vout | | |
| EXT-V Control | Io | Accuracy & linearity = $\pm 1\%$ of rated Iout | | |
| EXT-R Control | Vo | Accuracy & linearity = $\pm 1.5\%$ of rated Vout | | |
| EXT-R Control | Io | Accuracy & linearity = $\pm 1.5\%$ of rated Iout | | |
| Vo Monitor | | Accuracy = 1% | | |
| Io Monitor | | Accuracy = 1% | | |
| Front Panel Display Accuracy: 4 digits | | | | |
| Voltage | | 0.1% \pm 2 count | 0.1% \pm 2 count | 0.1% \pm 1 count |
| Current | | 0.1% \pm 1 count | 0.1% \pm 5 count | 0.1% \pm 3 count |
| Environmental Conditions: | Operating temp. | 0°C to 50°C | | |
| | Storage temp. | -25°C to 70°C | | |
| | Operating humidity | 20% to 85% RH; No condensation | | |
| | Storage humidity | 90% RH or less; No condensation | | |
| Interface | USB | TypeA: Host, TypeB: Slave, Speed: 1.1/2.0, USB Class: CDC(Communications Device Class) | | |
| | LAN | MAC Address, DNS IP Address, User Password, Gateway IP Address, Instrument IP Address, Subnet Mask | | |
| | GPIO | Optional: GUG-001 (GPIO to USB Adapter) | | |
| AC Input: | Nominal Input | 100 - 240 VAC; 50/60Hz | | |
| | Input Range | 85VAC ~ 265VAC | | |
| | Frequency | 47Hz ~ 63Hz | | |
| | Hold up Time | > 20ms (at rated load) | | |
| | Input Current | 15A@100VAC / 7.5A@200VAC | | |
| | Power (max) | 1500VA | | |
| | Power Factor (typ) | 0.98 | | |
| | Efficiency (typ) | 75% | 78% | 80% |
| Inrush Current | < 75Apeak | | | |

| | | |
|---------|-----------------------|--|
| General | Weight | Approx. 7kg |
| | Dimensions | W×H×D =214×124×350 mm |
| | Withstand Voltage | Chassis and output terminal; chassis and AC input; AC input and output terminal: AC 1500V or DC2130V 1 minute. |
| | Insulation Resistance | Chassis and output terminal; chassis and AC input; AC input and output terminal: 100MΩ or more (DC 500V) |

Type II

PSW 160-14.4/PSW 80-27/PSW 30-72 (mm)

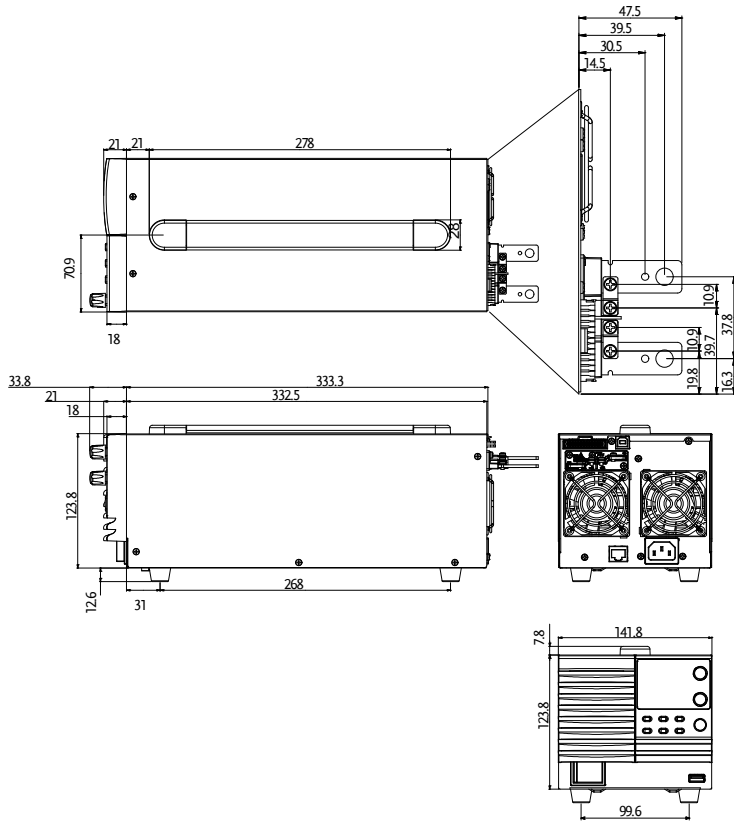

Type III

PSW 160-21.6/PSW 80-40.5/PSW 30-108 (mm)

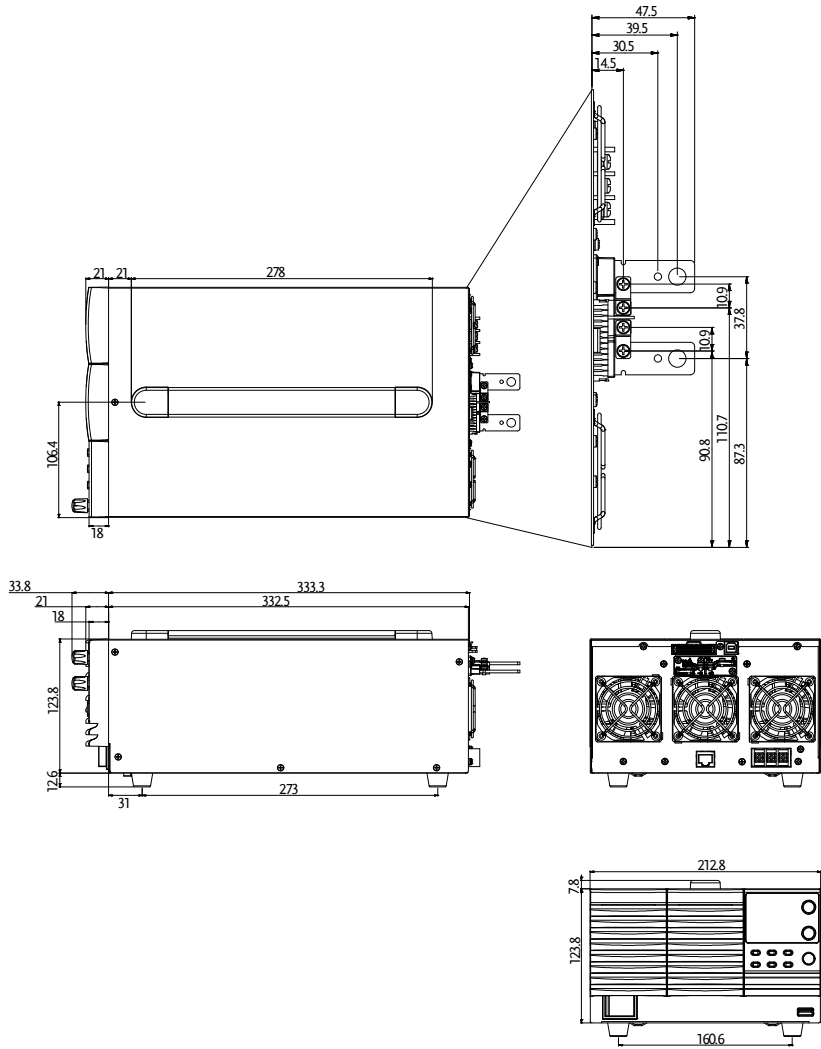

Declaration of Conformity

We

GOOD WILL INSTRUMENT CO., LTD.

No. 7-1, Jhongsing Rd, Tucheng Dist., New Taipei City 236, Taiwan

GOOD WILL INSTRUMENT (SUZHOU) CO., LTD.

No. 69 Lushan Road, Suzhou New District Jiangsu, China.

declare that the below mentioned product

Type of Product: Multi-Range DC Power Supply

Model Number: PSW 30-36, PSW 80-13.5, PSW 160-7.2, PSW 30-72, PSW 80-27, PSW 160-14.4, PSW 30-108, PSW 80-40.5, PSW 160-21.6

are herewith confirmed to comply with the requirements set out in the Council Directive on the Approximation of the Law of Member States relating to Electromagnetic Compatibility (2004/108/EC) and Low Voltage Directive (2006/95/EC).

For the evaluation regarding the Electromagnetic Compatibility and Low Voltage Directive, the following standards were applied:

| © EMC | |
|--|---|
| EN 61326-1: EN 61326-2-1: | Electrical equipment for measurement, control and laboratory use -- EMC requirements (2006) |
| Conducted & Radiated Emission EN 55011: 2009+A1:2010 | Electrostatic Discharge EN 61000-4-2: 2009 |
| Current Harmonics EN 61000-3-2: 2006+A1: 2009+A2: 2009 | Radiated Immunity EN 61000-4-3: 2006+A1:2008+A2:2010 |
| Voltage Fluctuations EN 61000-3-3: 2008 | Electrical Fast Transients IEC 61000-4-4: 2004+A1:2010 |
| ----- | Surge Immunity EN 61000-4-5: 2006 |
| ----- | Conducted Susceptibility EN 61000-4-6: 2009 |
| ----- | Power Frequency Magnetic Field EN 61000-4-8: 2010 |
| ----- | Voltage Dip/ Interruption EN 61000-4-11: 2004 |

| Low Voltage Equipment Directive 2006/95/EC | |
|--|--|
| Safety Requirements | EN 61010-1: 2010 EN 61010-2-030: 2010 |

INDEX

| | | | |
|-------------------------------------|-----|----------------------------------|-----|
| Accessories | 12 | CV mode | |
| Alarm | | operation..... | 51 |
| description..... | 27 | Declaration of conformity | 158 |
| Analog connector | | Default settings | 143 |
| pin assignment..... | 102 | reset..... | 45 |
| Analog control | | Dimensions | |
| output control | 113 | diagram..... | 157 |
| overview | 101 | Display format..... | 145 |
| remote monitoring | 118 | Display mode | |
| resistance control - current | | operation..... | 57 |
| output..... | 111 | Disposal instructions | 7 |
| resistance control - voltage | | EN61010 | |
| output..... | 109 | measurement category | 6 |
| shutdown control..... | 116 | pollution degree | 7 |
| status monitoring | 120 | Environment | |
| voltage control - current output107 | | safety instruction..... | 7 |
| voltage control - voltage output104 | | Error messages | 145 |
| Bleeder control | | Ethernet | |
| Description | 25 | interface..... | 126 |
| Build date | | sockets | 127 |
| view | 46 | web server | 126 |
| Caution symbol..... | 5 | FAQ..... | 137 |
| CC and CV mode | | Filter installation | 37 |
| description..... | 23 | Firmware update..... | 139 |
| CC mode | | Front panel diagram | 15 |
| operation..... | 54 | Ground | |
| Cleaning the instrument | 7 | symbol..... | 5 |
| Configuration | | Grounding..... | 31 |
| calibration settings..... | 97 | Internal resistance | |
| LAN settings | 94 | description..... | 26 |
| Normal function settings | 89 | LCD conversion..... | 145 |
| normal function settings | | Line voltage | |
| operation..... | 97 | PSW 30-108/80-40.5/160-21.6 | 35 |
| overview | 85 | List of features..... | 11 |
| power on configuration operation99 | | Load connection | 40 |
| power on configuration settings.96 | | Maintenance | |
| script test settings..... | 77 | replacing the filter | 136 |
| System settings | 95 | Marketing | |
| table | 85 | contact | 138 |
| test function settings | 78 | Messages | 145 |
| USB/GPIB settings..... | 93 | | |
| Conventions | 43 | | |

| | | | |
|----------------------------------|-----|---------------------------------|-----|
| Model differences | 10 | overview | 70 |
| OCP level..... | 49 | Service operation | |
| Operating area description | 21 | about disassembly | 6 |
| Operation considerations | 28 | contact | 138 |
| floating output | 31 | Slew rate | |
| inrush current | 28 | description..... | 25 |
| Pulsed loads | 28 | Socket server function check .. | 129 |
| reverse current | 29 | Specifications..... | 146 |
| OVP level..... | 49 | PSW 160-14.4W | 149 |
| Package contents | 14 | PSW 160-21.6..... | 152 |
| Panel lock | 58 | PSW 160-7.2 | 146 |
| Parallel mode | | PSW 30-108 | 152 |
| connection..... | 65 | PSW 30-36 | 146 |
| operation..... | 68 | PSW 30-72W | 149 |
| overview | 63 | PSW 80-13.5 | 146 |
| Power on/off | | PSW 80-27W | 149 |
| safety instruction..... | 6 | PSW 80-40.5 | 152 |
| Power up | 38 | System version | |
| Rack mount | | view | 46 |
| description | 43 | Test script | |
| Rear panel diagram..... | 18 | Export..... | 81 |
| Remote control..... | 123 | Load | 79 |
| interface configuration | 124 | overview | 77 |
| Remote control function check | 128 | remove/delete test | 82 |
| Remote sense | | Run..... | 80 |
| connection..... | 61 | UK power cord..... | 8 |
| operation..... | 59 | Updating the firmware | 139 |
| Series mode | | Warning symbol | 5 |
| connection..... | 72 | Web server function check | 129 |
| Operation..... | 74 | Wire gauge chart..... | 39 |