

**3/2, 5/2 and 5/3 Spool valves**  
**Solenoid actuated and pilot operated**  
**1/8 ... 1/2**

**High flow in-line valves**

**Compact and robust design**

**Low power energy efficient solenoids**

**Flexible in-line and manifold mounting options**



**Technical data**

Medium:

Compressed air, filtered to 40 µm,  
lubricated or non-lubricated

Operation:

Softseal spool valve, solenoid and pilot actuated

Mounting:

In-line or sub-base

Operating pressure:

Details of minimum and maximum pressure see overleaf.

Flow Characteristics:

Size	Function	l/min
1/8	3/2 & 5/2	480
1/8	5/3	270
1/4	3/2 & 5/2	1020
1/4	5/3	755
3/8	3/2 & 5/2	1705
3/8	5/3	1190
1/2	3/2 & 5/2	2480
1/2	5/3	1910

Ambient & medium temperature:

-5°C to +60°C pilot models

-5°C to +50°C solenoid models

(consult our Technical Service for use below +2°C)

**Materials**

Body/sub-base: die-cast aluminium alloy or aluminium alloy

Softseal spool: NBR/aluminium alloy

Mounting sheets/screws: steel

Springs: stainless steel

**Ordering information**

See page 3 (solenoid actuated valves) and  
4 (pneumatic actuated valves)

Alternative models

NPT ports

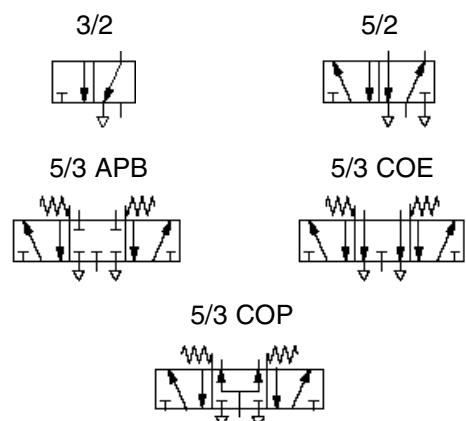

### Solenoid actuated valves

Symbol	Model	Function	Actuation	Pilot supply	Operating pressure (bar)	Flow (l/min)	Manual override	Weight (kg)	Drawing No.
	V50A413A-A2***	3/2	Solenoid/air	Internal	2 ... 8	480	Push & turn	0,120	1
	V51B417A-A2***	3/2	Solenoid/spring	Internal	2 ... 8	1020	Push & turn	0,203	2
	V52C417A-A2***	3/2	Solenoid/spring	Internal	2 ... 8	1705	Push & turn	0,350	2
	V53D417A-A2***	3/2	Solenoid/spring	Internal	2 ... 8	2480	Push & turn	0,353	2
	V50A411A-A2***	3/2	Solenoid/solenoid	Internal	2 ... 8	480	Push & turn	0,172	3
	V51B411A-A2***	3/2	Solenoid/solenoid	Internal	2 ... 8	1020	Push & turn	0,296	4
	V52C411A-A2***	3/2	Solenoid/solenoid	Internal	2 ... 8	1705	Push & turn	0,439	4
	V53D411A-A2***	3/2	Solenoid/solenoid	Internal	2 ... 8	2480	Push & turn	0,437	4
	V50A513A-A2***	5/2	Solenoid/air	Internal	2 ... 8	480	Push & turn	0,124	5
		V51B517A-A2***	5/2	Solenoid/spring	Internal	2 ... 8	1020	Push & turn	0,184
V52C517A-A2***		5/2	Solenoid/spring	Internal	2 ... 8	1705	Push & turn	0,293	6
V53D517A-A2***		5/2	Solenoid/spring	Internal	2 ... 8	2480	Push & turn	0,303	6
	V50A511A-A2***	5/2	Solenoid/solenoid	Internal	2 ... 8	480	Push & turn	0,176	7
	V51B511A-A2***	5/2	Solenoid/solenoid	Internal	2 ... 8	1020	Push & turn	0,292	8
	V52C511A-A2***	5/2	Solenoid/solenoid	Internal	2 ... 8	1705	Push & turn	0,452	8
	V53D511A-A2***	5/2	Solenoid/solenoid	Internal	2 ... 8	2480	Push & turn	0,190	8
	V50A611A-A2***	5/3 APB	Solenoid/solenoid	Internal	3 ... 8	270	Push & turn	0,338	9
	V51B611A-A2***	5/3 APB	Solenoid/solenoid	Internal	3 ... 8	755	Push & turn	0,387	10
	V52C611A-A2***	5/3 APB	Solenoid/solenoid	Internal	3 ... 8	1190	Push & turn	0,565	11
	V53D611A-A2***	5/3 APB	Solenoid/solenoid	Internal	3 ... 8	1910	Push & turn	0,634	11
	V50A711A-A2***	5/3 COE	Solenoid/solenoid	Internal	3 ... 8	270	Push & turn	0,338	9
	V51B711A-A2***	5/3 COE	Solenoid/solenoid	Internal	3 ... 8	755	Push & turn	0,387	10
	V52C711A-A2***	5/3 COE	Solenoid/solenoid	Internal	3 ... 8	1190	Push & turn	0,565	11
	V53D711A-A2***	5/3 COE	Solenoid/solenoid	Internal	3 ... 8	1910	Push & turn	0,634	11
	V50A811A-A2***	5/3 COP	Solenoid/solenoid	Internal	3 ... 8	270	Push & turn	0,338	9
	V51B811A-A2***	5/3 COP	Solenoid/solenoid	Internal	3 ... 8	755	Push & turn	0,387	10
	V52C811A-A2***	5/3 COP	Solenoid/solenoid	Internal	3 ... 8	1190	Push & turn	0,565	11
	V53D811A-A2***	5/3 COP	Solenoid/solenoid	Internal	3 ... 8	1910	Push & turn	0,634	11

\*\*\* Insert coil code from below tables

APB = All Ports Blocked, COE = Centre Open Exhaust, COP = Centre Open Pressure.

### V50 series only

#### Voltage codes and spare solenoid kits

Voltage	Code	Power Inrush/hold	Solenoid Kit Model
12 V d.c.	12A	2,5 W	V12958-A12
24 V d.c.	13A	2,5 W	V12958-A13
110/120 V a.c. 50/60 Hz	18A	4,8/3,6 VA	V12958-A18
220/240 V a.c. 50/60 Hz	19A	4,8/3,6 VA	V12958-A19

#### Electrical details for solenoid operators

Voltage tolerances	+/- 10%
Rating	100 % Continuous duty
Inlet orifice	0,6 mm
Materials	PPS (body), FKM and NBR (seal)
Insulation class	F class
Connector type	15 mm DIN EN 175301-803 (DIN 43650), Form C
Protection class	IP65 (with sealed plugs)

### V51 ... V53 series

#### Voltage codes and spare solenoid kits

Voltage	Code	Power Inrush/hold	Solenoid Kit Model
12 V d.c.	12J	2 W	QM/48/12J/21
24 V d.c.	13J	2 W	QM/48/13J/21
110/120 V a.c. 50/60 Hz	18J	4/2,5 VA	QM/48/18J/21
220/240 V a.c. 50/60 Hz	19J	6/5 VA	QM/48/19J/21

#### Electrical details for solenoid operators

Voltage tolerances	+/- 10%
Rating	100 % Continuous duty
Inlet orifice	0,8 mm
Materials	PPS (body), FKM and NBR (seal)
Insulation class	F class
Connector type	22 mm industrial standard
Protection class	IP65 (with sealed plugs)

**Options selector**

V5\*\*\*1\*A-A2\*\*\*

Thread size	Substitute
1/8"	0
1/4"	1
3/8"	2
1/2"	3

Thread	Substitute
G 1/8	A
G 1/4	B
G 3/8	C
G 1/2	D

NPT thread	Substitute
1/8 NPT	P
1/4 NPT	R
3/8 NPT	S
1/2 NPT	T

Voltage (V50 valve series)	Substitute
12 V d.c. 2,9 W	12A
24 V d.c. 2,9 W	13A
110/120 V a.c. (50/60 Hz) 3,7/3,1 VA	18A
220/240 V a.c. (50/60 Hz) 3,7/3,1 VA	19A

Voltage (V51 ... V53 valve series)	Substitute
12 V d.c. 2 W	12J
24 V d.c. 2 W	13J
110/120 V a.c. (50/60 Hz) 4/2,5 VA	18J
220/240 V a.c. (50/60 Hz) 6/5 VA	19J

Actuation	Substitute
Solenoid/Air	3
Solenoid/Spring	7
Solenoid/Solenoid	1

Function	Substitute
3/2 Normally closed	4
5/2	5
5/3 All ports blocked	6
5/3 Centre open exhaust	7
5/3 Centre open pressure	8

**Ordering example**

To order a 5/2 solenoid valve, G 1/4 ports, spring return, 24 V d.c.  
**quote: V51B517A-A213J**

### Pilot actuated valves

Symbol	Model	Function	Pilot	Mid position	Return	Operating pressure (bar)	Pilot pressure (bar)	Flow (l/min)	Weight (kg)	Drawing No.
	V50A4D3A-XA090	3/2	Air		Air spring	0 ... 8	1,5 ... 8	480	0,061	12
	V51B4D7A-XA090	3/2	Air		Spring	0 ... 8	1,5 ... 8	1020	0,122	13
	V52C4D7A-XA090	3/2	Air		Spring	0 ... 8	2 ... 8	1705	0,295	13
	V53D4D7A-XA090	3/2	Air		Spring	0 ... 8	2 ... 8	2480	0,300	13
	V50A4DDA-XA020	3/2	Air		Air	0 ... 8	1,5 ... 8	480	0,074	14
	V51B4DDA-XA020	3/2	Air		Air	0 ... 8	1,5 ... 8	1020	0,134	15
	V52C4DDA-XA020	3/2	Air		Air	0 ... 8	2 ... 8	1705	0,324	15
	V53D4DDA-XA020	3/2	Air		Air	0 ... 8	2 ... 8	2480	0,326	15
	V50A5D3A-XA090	5/2	Air		Air spring	0 ... 8	1,5 ... 8	480	0,071	16
	V51B5D7A-XA090	5/2	Air		Spring	0 ... 8	1,5 ... 8	1020	0,106	17
	V52C5D7A-XA090	5/2	Air		Spring	0 ... 8	2 ... 8	1705	0,236	17
	V53D5D7A-XA090	5/2	Air		Spring	0 ... 8	2 ... 8	2480	0,275	17
	V50A5DDA-XA020	5/2	Air		Air	0 ... 8	1,5 ... 8	480	0,084	18
	V51B5DDA-XA020	5/2	Air		Air	0 ... 8	1,5 ... 8	1020	0,134	19
	V52C5DDA-XA020	5/2	Air		Air	0 ... 8	2 ... 8	1705	0,236	19
	V53D5DDA-XA020	5/2	Air		Air	0 ... 8	2 ... 8	2480	0,750	19
	V50A6DDA-XA020	5/3	Air	APB	Air	0 ... 8	1,5 ... 8	270	0,095	20
	V51B6DDA-XA020	5/3	Air	APB	Air	0 ... 8	1,5 ... 8	755	0,179	21
	V52C6DDA-XA020	5/3	Air	APB	Air	0 ... 8	2 ... 8	1190	0,301	22
	V53D6DDA-XA020	5/3	Air	APB	Air	0 ... 8	2 ... 8	1910	0,338	22
	V50A7DDA-XA020	5/3	Air	COE	Air	0 ... 8	1,5 ... 8	270	0,095	20
	V51B7DDA-XA020	5/3	Air	COE	Air	0 ... 8	1,5 ... 8	755	0,179	21
	V52C7DDA-XA020	5/3	Air	COE	Air	0 ... 8	2 ... 8	1190	0,301	22
	V53D7DDA-XA020	5/3	Air	COE	Air	0 ... 8	2 ... 8	1910	0,338	22
	V50A8DDA-XA020	5/3	Air	COP	Air	0 ... 8	1,5 ... 8	270	0,095	20
	V51B8DDA-XA020	5/3	Air	COP	Air	0 ... 8	1,5 ... 8	755	0,179	21
	V52C8DDA-XA020	5/3	Air	COP	Air	0 ... 8	2 ... 8	1190	0,301	22
	V53D8DDA-XA020	5/3	Air	COP	Air	0 ... 8	2 ... 8	1910	0,338	22

APB = All Ports Blocked, COE = Centre Open Exhaust, COP = Centre Open Pressure.

### Options selector





V5★ ★ ★ D★ A-X★ 0★ 0

<b>Thread size</b>	<b>Substitute</b>	<b>Air function</b>	<b>Substitute</b>
1/8"	0	Pilot operated/pilot return	2
1/4"	1	Pilot operated/spring return	9
3/8"	2		
1/2"	3	<b>Pilot port thread</b>	<b>Substitute</b>
		G 1/8	A
		1/8 NPT	P
<b>Thread</b>	<b>Substitute</b>	<b>Return</b>	<b>Substitute</b>
G 1/8	A	Air spring	3
G 1/4	B	Spring	7
G 3/8	C	Air	D
G 1/2	D	<b>Function</b>	<b>Substitute</b>
<b>NPT thread</b>	<b>Substitute</b>	3/2 Normally closed	4
1/8 NPT	P	5/2	5
1/4 NPT	R	5/3 All ports blocked	6
3/8 NPT	S	5/3 Centre open exhaust	7
1/2 NPT	T	5/3 Centre open pressure	8

### Ordering example

To order a 5/2 valve, G3/8 ports, air pilot, spring return  
**quote: V52C5D7A-XA090**

**Manifold system and blanking plates**

Manifold for 3 port valves		Blanking plate for 3 port valves		Manifold for 5 port valves		Blanking plate for 5 port valves	
							
For valve series	page 16		page 17		page 16		page 17
V50	V50A3**		V500351		V50A5**		V500551
V51	V51B3**		V510351		V51B5**		V510551
V52	V52C3**		V520351		V52C5**		V520551
V53	V53D3**		V530351		V53D5**		V530551

\*\* Number of station 02 ... 09 for 2 ... 9 stations  
 Number of station 10 for 10 stations

**Connectors for V50**

Connectors, 15 mm DIN EN 175301-803 (DIN 43650), Form C



V10027-D00 (12 ... 250 V a.c./d.c.)
V10013-D01 (12 ... 250 V a.c./d.c., 1 m moulded cable)
V10012-D13 (12 ... 24 V d.c. LED, surge suppression)
V10012-D18 (110 V a.c., LED, surge suppression)
V10012-D19 (220 V a.c., LED, surge suppression)



**Connectors for V51 to V53**

Connectors, 22 mm industrial standard



M/P19063 (12 ... 250 V a.c./d.c.)
M/P43313/1 (12 ... 250 V a.c./d.c., 1m moulded cable)
M/P24121/1 (12 ... 24 V d.c. lamp, surge suppression)
M/P24121/2 (90 ... 130 V a.c. neon, surge suppression)
M/P24121/3 (150 ... 250 V a.c. neon, surge suppression)

**Accessories**

Silencers plastic		Silencers sintered bronze		Plug	
					
Valve series	Model	Model	Model	Model	Model
V50	M/S1	T40C1800		160050018	
V51	M/S1	T40C1800		160050028	
V52	M/S3	T40C3800		160050038	
V53	M/S4	T40C4800		160050048	
Manifold series	Model	Model	Model	Model	Model
V50	M/S2	T40C2800		160050028	
V51	M/S2	T40C2800		160050028	
V52	M/S3	T40C3800		160050038	
V53	M/S4	T40C4800		160050048	

**Valve dimensions**

**3/2 Single solenoid pilot valve,  
1/8" port  
Air return**

①

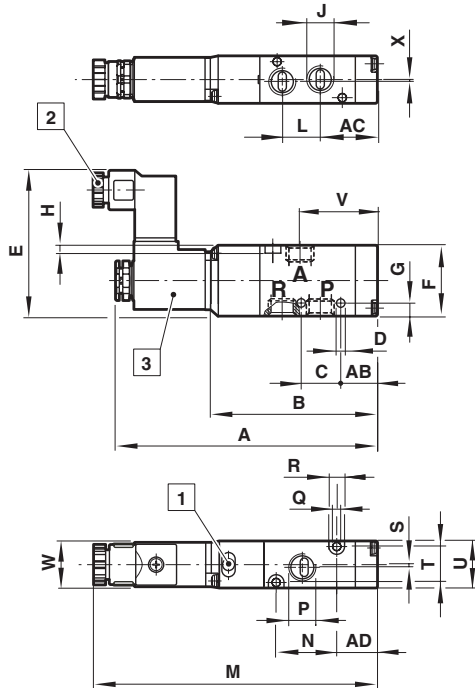

**3/2 Single solenoid pilot valve,  
1/4" ... 1/2" ports  
Spring return**

②

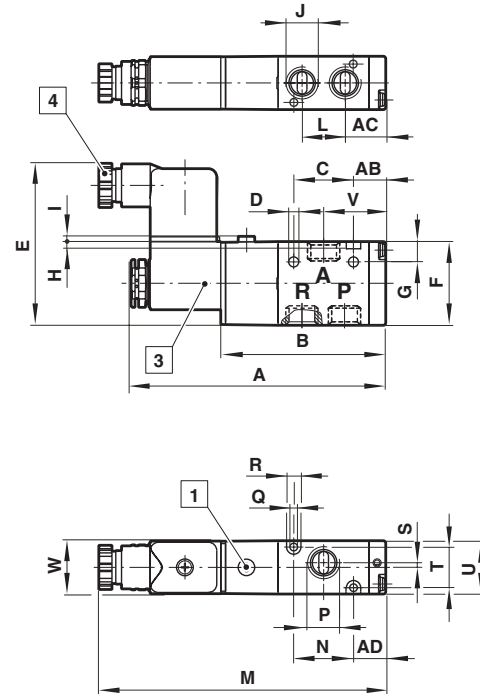

- ① Manual override (Push and Turn)
- ② Gland size Pg 7
- ③ Solenoid rotates 2 x 180° (V50), 4 x 90° (V51 ... V53)
- ④ Gland size Pg 9

Serie	Drawing	A	AB	AC	AD	B	C	D	E	F	G	H	I	J
V50	1	99,5	13,5	21,5	15,5	65	15	3,2	55,5	27	5	3	-	1/8"
V51	2	106,5	13,5	17	13,5	69	25	4,2	67	35	8,5	3	3	1/4"
V52	2	126,5	13	26	15	89	26	4,5	73	46,5	39,5	4	3	3/8"
V53	2	133	12,5	27	15	96	29	4,5	73	46,5	39,5	4	3	1/2"
Serie	Drawing	L	M	N	P	Q	R	S	T	U	V	W	X	
V50	1	14,5	108	23	1/8"	3,2	6	1	13	18	29,5	16	0,5	
V51	2	18	120	25	1/4"	3,2	6	2	17	22,5	26	22	-	
V52	2	26	139,5	41	3/8"	4,5	8	-	23	30	41	22	-	
V53	2	29	146	48	1/2"	4,2	8	2,5	23	30	40,5	22	-	

**3/2 Double solenoid pilot valve,  
1/8" port**

**3/2 Double solenoid pilot valve,  
1/4" ... 1/2" ports**

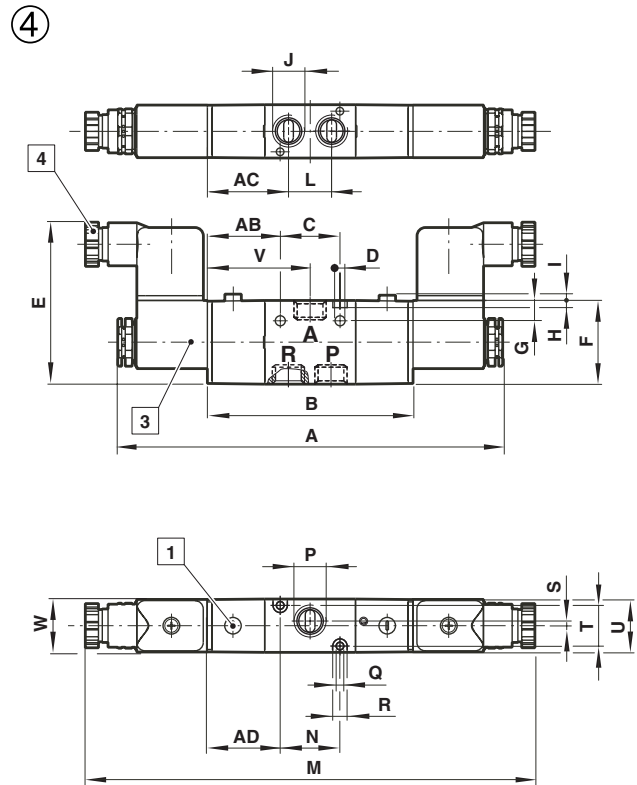
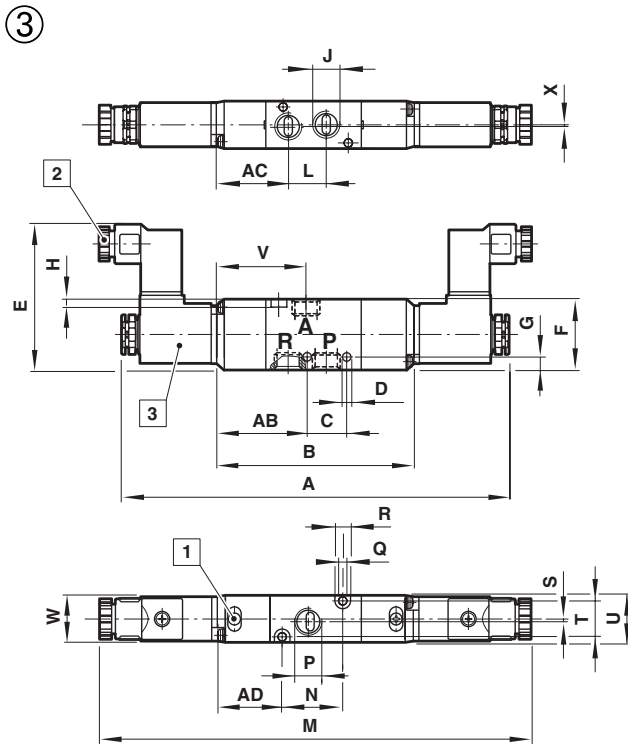

- 1 Manual override (Push and Turn)
- 2 Gland size Pg 7
- 3 Solenoid rotates 2 x 180° (V50), 4 x 90° (V51 ... V53)
- 4 Gland size Pg 9

Serie	Drawing	A	AB	AC	AD	B	C	D	E	F	G	H	I	J
V50	3	144,5	36,5	29	27	76,5	15	3,2	55,5	27	5	3	-	1/8"
V51	4	144,5	30,5	34	30,5	86	25	4,2	67	35	8,5	3	3	1/4"
V52	4	182	31	44	33	107	26	4,5	73	46,5	39,5	4	3	3/8"
V53	4	188	30,5	45	33	114	29	4,5	73	46,5	39,5	4	3	1/2"
Serie	Drawing	L	M	N	P	Q	R	S	T	U	V	W	X	
V50	3	14,5	161,5	23	1/8"	3,2	6	1	13	18	35,5	16	0,5	
V51	4	18	188	25	1/4"	3,2	6	2	17	22,5	43	22	-	
V52	4	26	208	41	3/8"	4,5	8	-	23	30	59	22	-	
V53	4	29	214	48	1/2"	4,2	8	2,5	23	30	58,5	22	-	

**5/2 Single solenoid pilot valve,  
1/8" port  
Air return**

⑤

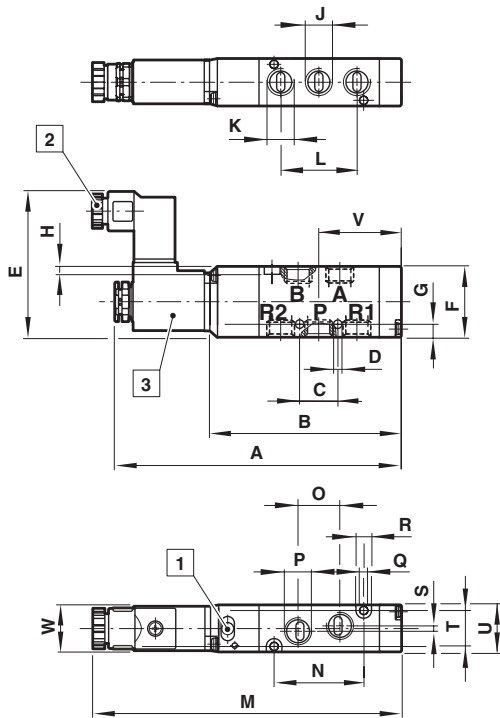

**5/2 Single solenoid pilot valve,  
1/4" ... 1/2" ports  
Spring return**

⑥

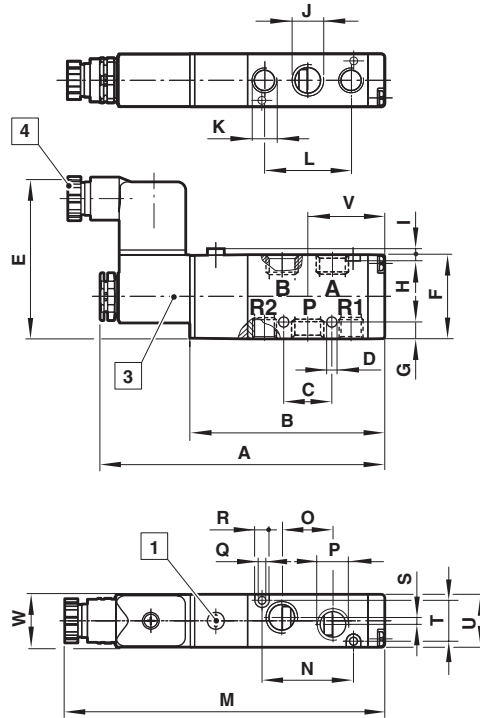

- 1 Manual override (Push and Turn)
- 2 Gland size Pg 7
- 3 Solenoid rotates 2 x 180° (V50), 4 x 90° (V51 ... V53)
- 4 Gland size Pg 9

Serie	Drawing	A	B	C	D	E	F	G	H	I	J	K	L
V50	5	110	76	14,5	3,2	54	27	5	3	-	1/8"	1/8"	29
V51	6	118,5	81	20	4,2	67	35	7	3	3	1/4"	1/8"	36
V52	6	145,5	108	26	5,5	73	46,5	4,5	4	3	3/8"	3/8"	52
V53	6	157	120	29	4,5	73	46,5	7	4	3	1/2"	1/2"	58
Serie	Drawing	M	N	O	P	Q	R	S	T	U	V	W	
V50	5	118,5	34	16	1/8"	3,2	6	2	13	18	32,5	16	
V51	6	132	38	21	1/4"	3,2	6	3	17	22,5	32	22	
V52	6	158,5	13	30	3/8"	4,5	8	-	23	30	45	22	
V53	6	170	72	28	1/2"	4,2	8	4,5	23	30	51	22	



**5/2 Double solenoid pilot valve,  
1/8" port**

⑦

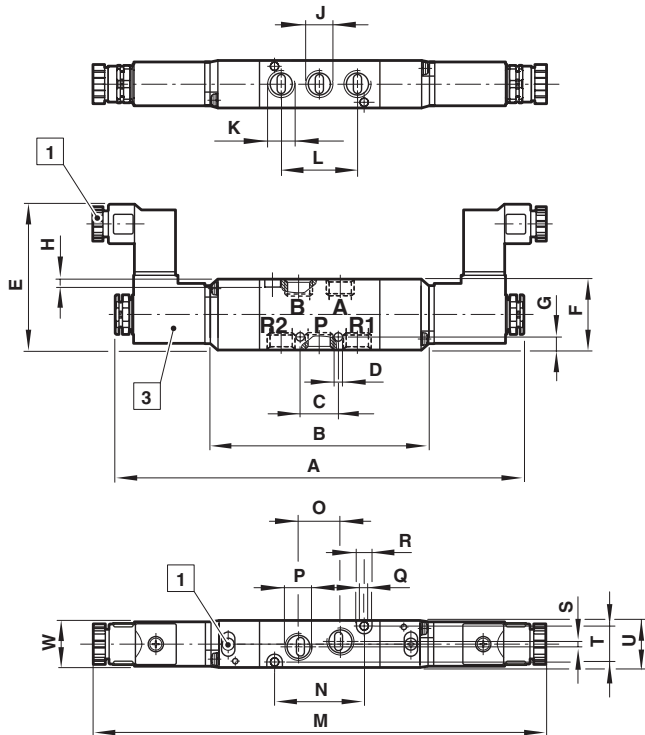

**5/2 Double solenoid pilot valve,  
1/4" ... 1/2" ports**

⑧

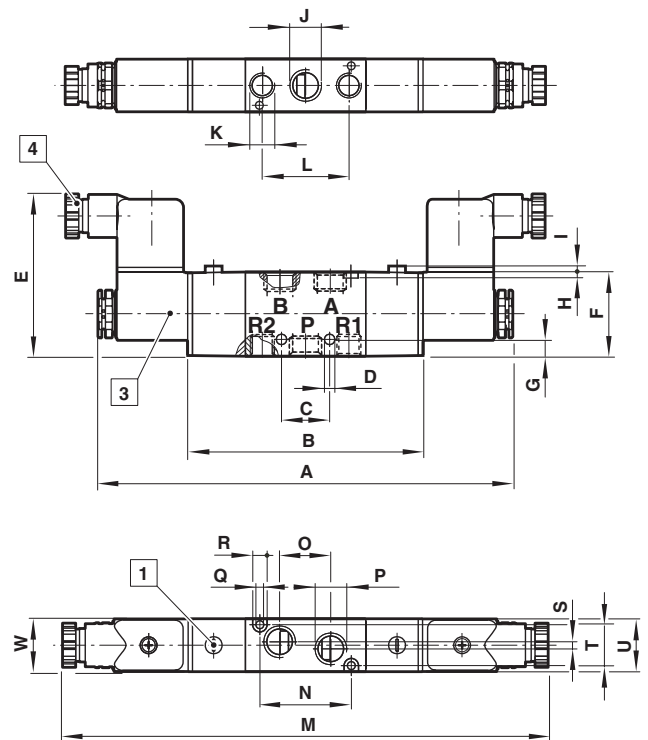

- 1 Manual override (Push and Turn)
- 2 Gland size Pg 7
- 3 Solenoid rotates 2 x 180° (V50), 4 x 90° (V51 ... V53)
- 4 Gland size Pg 9

Serie	Drawing	A	B	C	D	E	F	G	H	I	J	K	L
V50	7	155	87	14,5	3,2	55	27	5	3	-	1/8"	1/8"	29
V51	8	173	98	20	4,2	67	35	7	3	3	1/4"	1/8"	36
V52	8	201	126	26	5,5	73	46,5	4,5	4	3	3/8"	3/8"	52
V53	8	212	138	29	4,5	73	46,5	7	4	3	1/2"	1/2"	58
Serie	Drawing	M	N	O	P	Q	R	S	T	U	W		
V50	7	172	34	16	1/8"	3,2	6	2	13	18	16		
V51	8	200	38	21	1/4"	3,2	6	3	17	22,5	22		
V52	8	228	13	30	3/8"	4,5	8	-	23	30	22		
V53	8	238	72	28	1/2"	4,2	8	4,5	23	30	22		

**5/3 Double solenoid pilot valve,  
1/8" port**

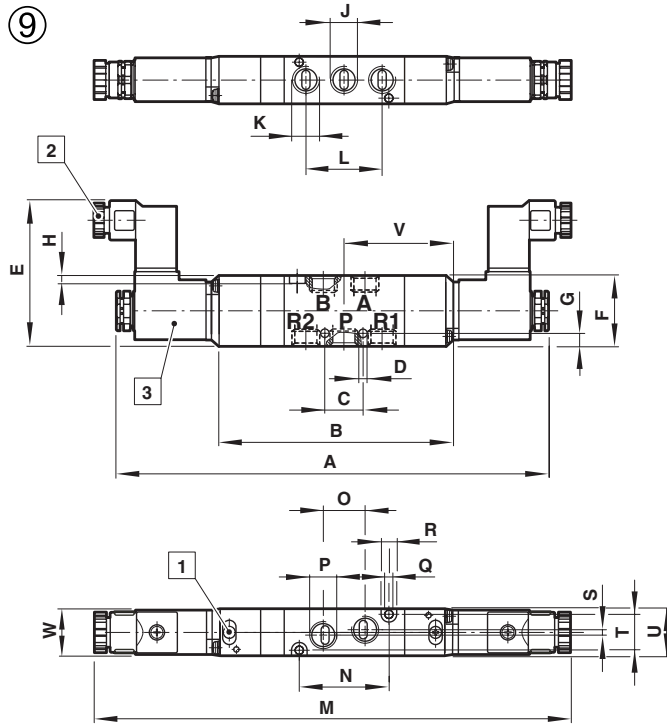

**5/3 Double solenoid pilot valve,  
1/4" ports**

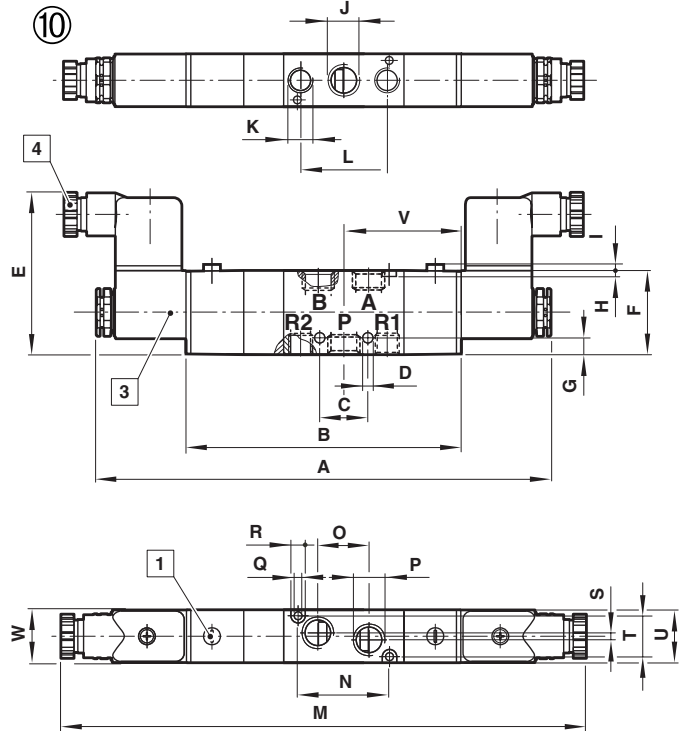

**5/3 Double solenoid pilot valve,  
3/8" and 1/2" ports**

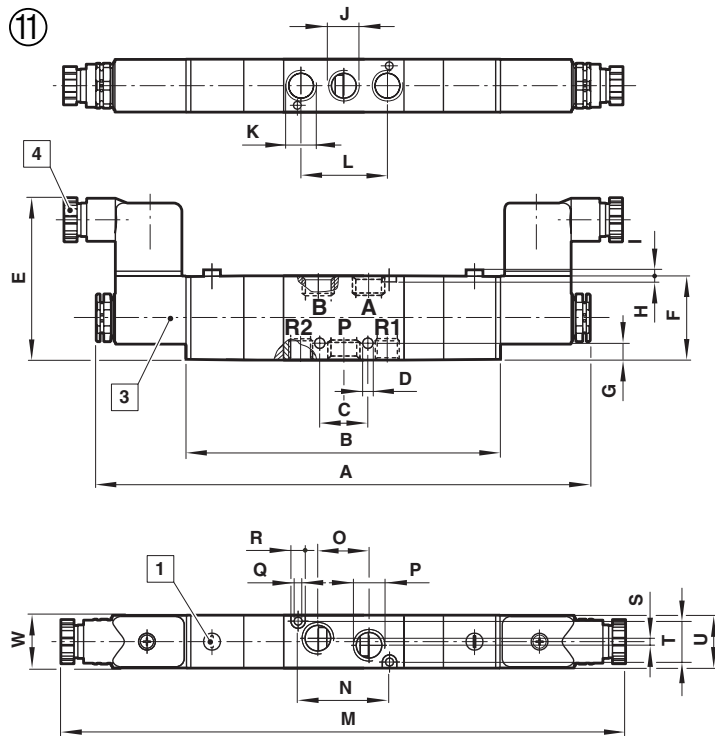

- 1 Manual override (Push and Turn)
- 2 Gland size Pg 7
- 3 Solenoid rotates 2 x 180° (V50), 4 x 90° (V51 ... V53)
- 4 Gland size Pg 9

Serie	Drawing	A	B	C	D	E	F	G	H	I	J	K	L
V50	9	164	96	14,5	3,2	55	27	5	3	-	1/8"	1/8"	29
V51	10	194	119	20	4,2	67	35	7	3	3	1/4"	1/8"	36
V52	11	254,5	179,5	26	5,5	73	46,5	4,5	4	3	3/8"	3/8"	52
V53	11	265,5	191,5	29	4,5	73	46,5	7	4	3	1/2"	1/2"	58
Serie	Drawing	M	N	O	P	Q	R	S	T	U	V	W	
V50	9	181	34	16	1/8"	3,2	6	2	13	18	43,5	16	
V51	10	221	38	21	1/4"	3,2	6	3	17	22,5	48,5	22	
V52	11	281,5	13	30	3/8"	4,5	8	-	23	30	-	22	
V53	11	291,5	72	28	1/2"	4,2	8	4,5	23	30	-	22	

**3/2 Single air pilot valve,  
1/8" port  
Air spring return**

⑫

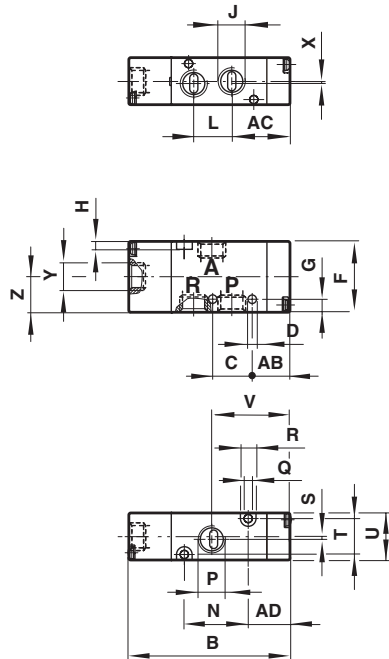

**3/2 Single air pilot valve,  
1/4" ... 1/2" ports  
Spring return**

⑬

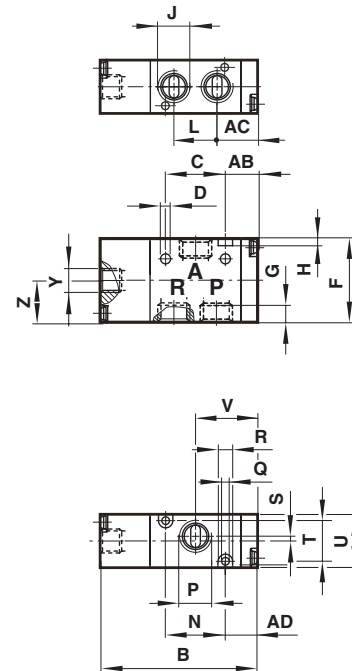

Serie	Drawing	AB	AC	AD	B	C	D	F	G	H	J	L
V50	12	13,5	21,5	15,5	61,5	15	3,2	27	5	3	1/8"	14,5
V51	13	13,5	17	13,5	65,5	25	4,2	35	8,5	3	1/4"	18
V52	13	13	26	15	87	26	4,5	46,5	39,5	4	3/8"	26
V53	13	12,5	27	15	94	29	4,5	46,5	39,5	4	1/2"	29
Serie	Drawing	N	P	Q	R	S	T	U	V	X	Y	Z
V50	12	23	1/8"	3,2	6	1	13	18	29,5	0,5	1/8"	13,5
V51	13	25	1/4"	3,2	6	2	17	22,5	26	-	1/8"	17,5
V52	13	41	3/8"	4,5	8	-	23	30	41	-	1/8"	17
V53	13	48	1/2"	4,2	8	2,5	23	30	40,5	-	1/8"	17

**3/2 Double air pilot valve,  
1/8" port**

⑭

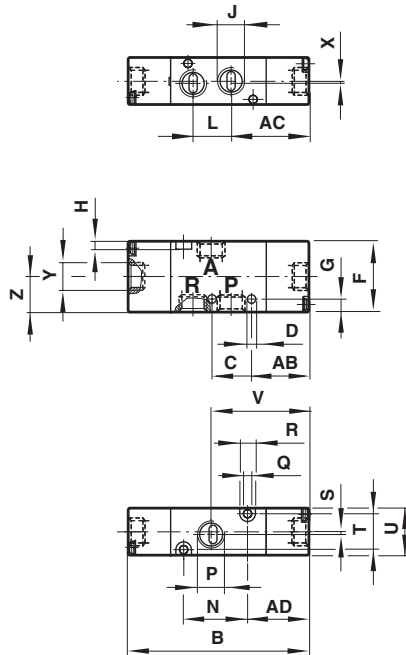

**3/2 Double air pilot valve,  
1/4" ... 1/2" ports**

⑮

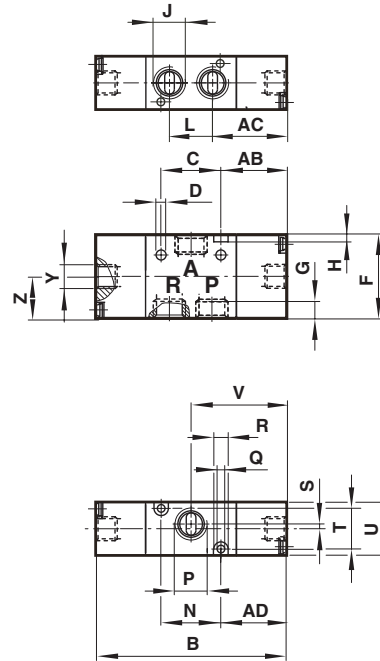

Serie	Drawing	AB	AC	AD	B	C	D	F	G	H	J	L
V50	14	13,5	21,5	15,5	69	15	3,2	27	5	3	1/8"	14,5
V51	15	13,5	17	13,5	79	25	4,2	35	8,5	3	1/4"	18
V52	15	13	26	15	103	26	4,5	46,5	39,5	4	3/8"	26
V53	15	12,5	27	15	110	29	4,5	46,5	39,5	4	1/2"	29
Serie	Drawing	N	P	Q	R	S	T	U	V	X	Y	Z
V50	14	23	1/8"	3,2	6	1	13	18	29,5	0,5	1/8"	13,5
V51	15	25	1/4"	3,2	6	2	17	22,5	26	-	1/8"	17,5
V52	15	41	3/8"	4,5	8	-	23	30	41	-	1/8"	17
V53	15	48	1/2"	4,2	8	2,5	23	30	40,5	-	1/8"	17

**5/2 Single air pilot valve,  
1/8" port  
Air spring return**

①⑥

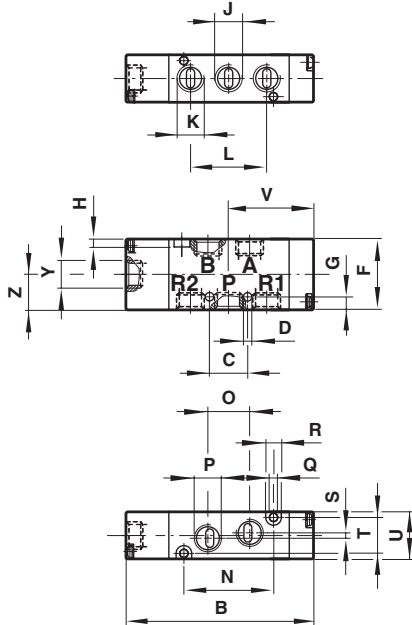

**5/2 Single air pilot valve,  
1/4" ... 1/2" ports  
Spring return**

①⑦

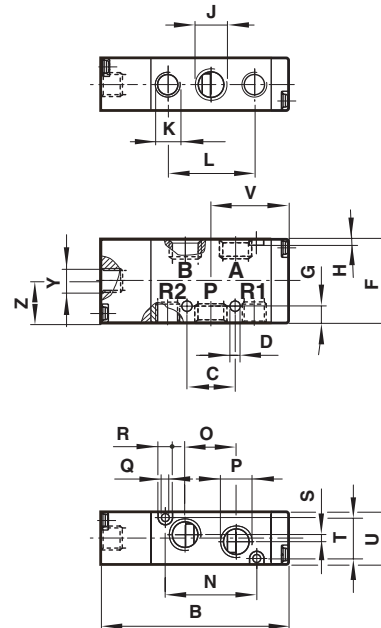

Serie	Drawing	B	C	D	F	G	H	J	K	L	N
V50	16	72,5	14,5	3,2	27	5	3	1/8"	1/8"	29	34
V51	17	77,5	20	4,2	35	7	3	1/4"	1/8"	36	38
V52	17	106	26	5,5	46,5	4,5	4	3/8"	3/8"	52	13
V53	17	118	29	4,5	46,5	7	4	1/2"	1/2"	58	72
Serie	Drawing	O	P	Q	R	S	T	U	V	Y	Z
V50	16	16	1/8"	3,2	6	2	13	18	32,5	1/8"	13,5
V51	17	21	1/4"	3,2	6	3	17	22,5	32	1/8"	17,5
V52	17	30	3/8"	4,5	8	-	23	30	45	1/8"	17
V53	17	28	1/2"	4,2	8	4,5	23	30	51	1/8"	17

**5/2 Double air pilot valve,  
1/8" port**

18

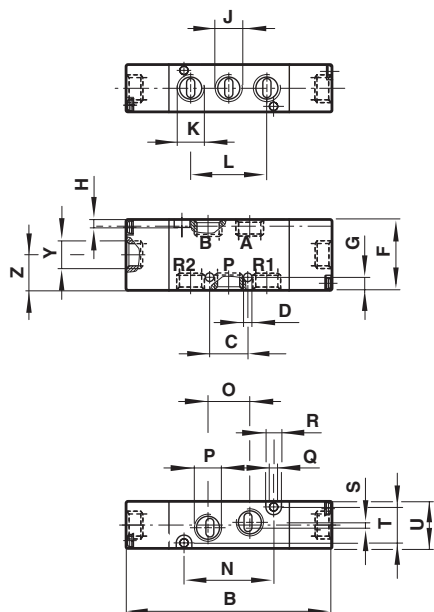

**5/2 Double air pilot valve,  
1/4" ... 1/2" ports**

19

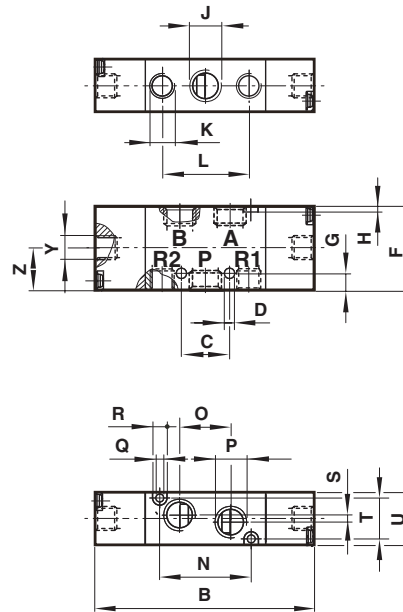

Serie	Drawing	B	C	D	F	G	H	J	K	L	N
V50	18	80	14,5	3,2	27	5	3	1/8"	1/8"	29	34
V51	19	91	20	4,2	35	7	3	1/4"	1/8"	36	38
V52	19	122	26	5,5	46,5	4,5	4	3/8"	3/8"	52	13
V53	19	134	29	4,5	46,5	7	4	1/2"	1/2"	58	72
Serie	Drawing	O	P	Q	R	S	T	U	Y	Z	
V50	18	16	1/8"	3,2	6	2	13	18	1/8"	13,5	
V51	19	21	1/4"	3,2	6	3	17	22,5	1/8"	17,5	
V52	19	30	3/8"	4,5	8	-	23	30	1/8"	17	
V53	19	28	1/2"	4,2	8	4,5	23	30	1/8"	17	

**5/3 Double air pilot valve,  
1/8" port**

20

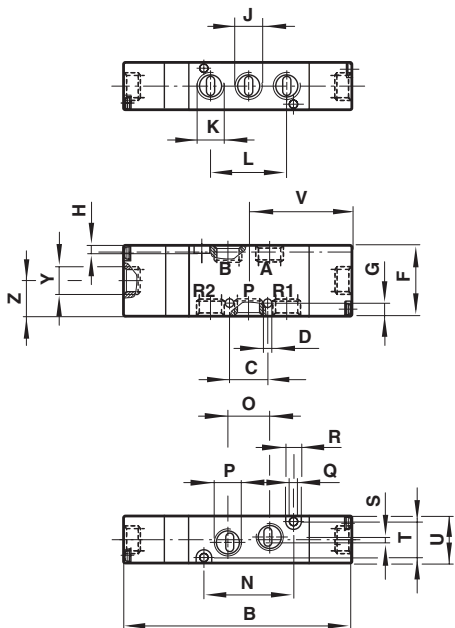

**5/3 Double air pilot valve,  
1/4" port**

21

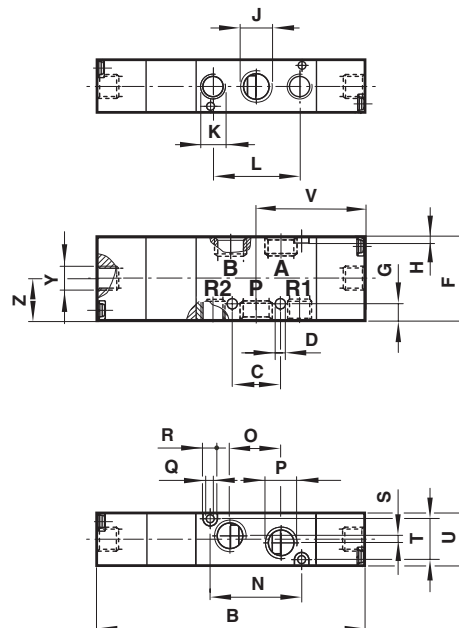

**5/3 Double air pilot valve,  
3/8" and 1/2" ports**

22

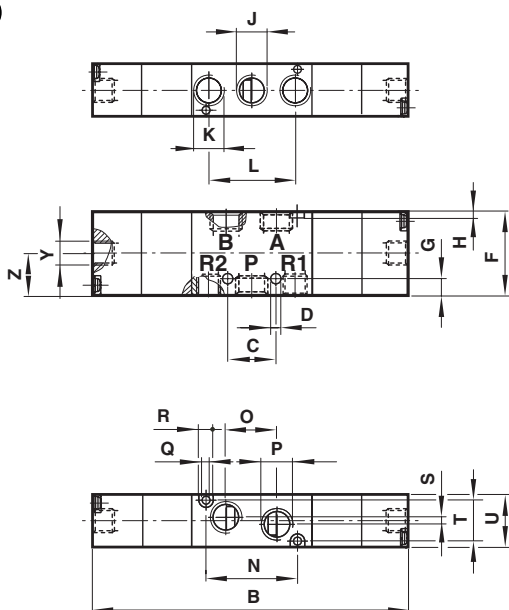

Serie	Drawing	B	C	D	F	G	H	J	K	L	N
V50	20	89	14,5	3,2	27	5	3	1/8"	1/8"	29	34
V51	21	112	20	4,2	35	7	3	1/4"	1/8"	36	38
V52	22	175,5	26	5,5	46,5	4,5	4	3/8"	3/8"	52	13
V53	22	187,5	29	4,5	46,5	7	4	1/2"	1/2"	58	72
Serie	Drawing	O	P	Q	R	S	T	U	V	Y	Z
V50	20	16	1/8"	3,2	6	2	13	18	40	1/8"	13,5
V51	21	21	1/4"	3,2	6	3	17	22,5	45,5	1/8"	17,5
V52	22	30	3/8"	4,5	8	-	23	30	87,5	1/8"	17
V53	22	28	1/2"	4,2	8	4,5	23	30	93,5	1/8"	17

**Manifold system, 3/2 valves**

For V50 and V51

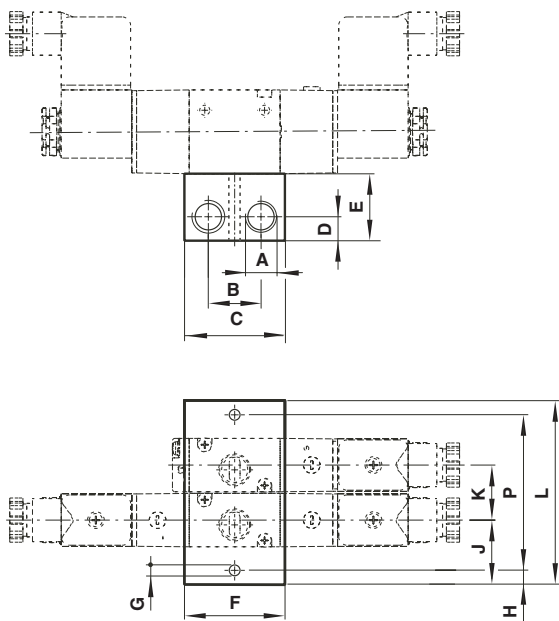

for V52 and V53

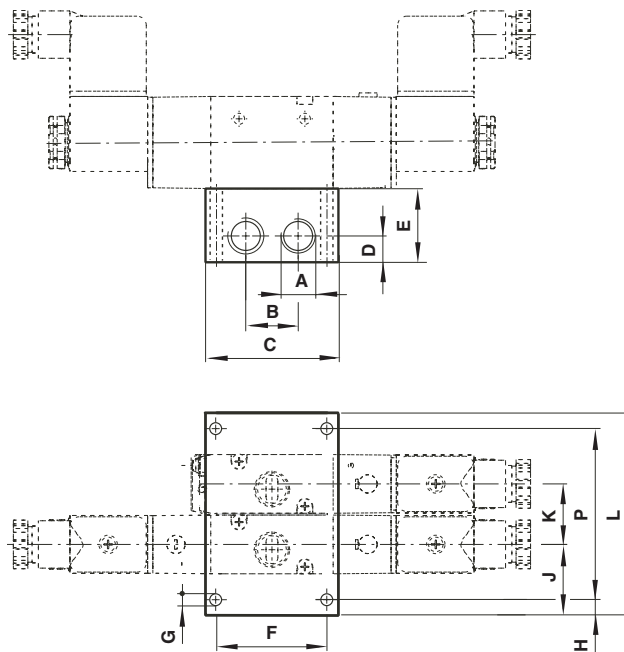

Serie	A	B	C	D	E	Ø G	H	J	K	L	P	Weight (kg)
V50	1/4"	22	42	10	28	4,5	5	19	19	19 + (N x 19)	9 + (N x 19)	0,05 + (N x 0,05)
V51	1/4"	22	42	10	28	4,5	6	27	23	31 + (N x 23)	19 + (N x 23)	0,08 + (N x 0,06)
V52	3/8"	26	66	11,5	27	4,5	5	25	31	19 + (N x 31)	9 + (N x 31)	0,06 + (N x 0,11)
V53	1/2"	30	72	15	32	4,5	5	25	31	19 + (N x 31)	9 + (N x 31)	0,07 + (N x 0,14)

N = Number of stations 2 to 10

**Manifold system, 5/2 valves**

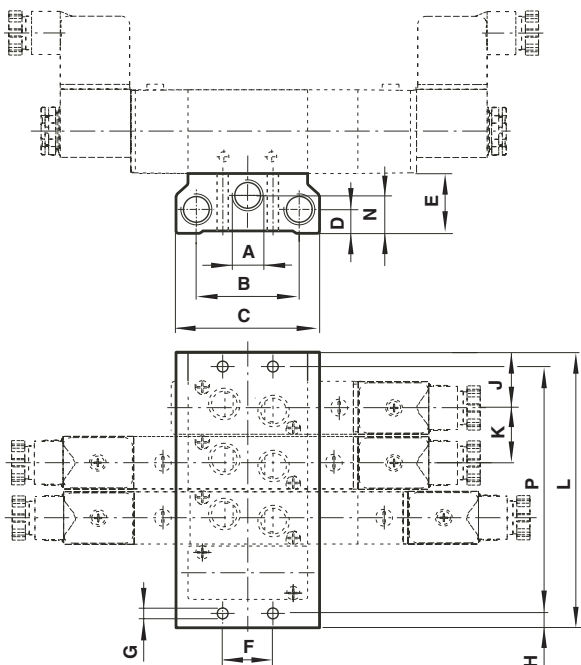

Serie	A	B	C	D	E	F	Ø G	H	J	K	L	P	Weight (kg)
V50	1/4"	40	58	11	25	20	4,5	5	19	19	19 + (N x 19)	9 + (N x 19)	0,04 + (N x 0,04)
V51	1/4"	43	60	10	25	21	4,5	6	23	23	23 + (N x 23)	11 + (N x 23)	0,07 + (N x 0,06)
V52	3/8"	61	84	12	27	30	4,5	5	25	31	19 + (N x 31)	9 + (N x 31)	0,06 + (N x 0,09)
V53	1/2"	58	96	13	30	30	4,5	5	25	31	19 + (N x 31)	9 + (N x 31)	0,08 + (N x 0,15)

N = Number of stations 2 to 10



## Blanking plate

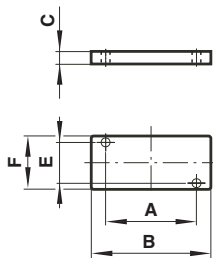

Type	For function	A	B	C	E	F	Weight (kg)
V500351	3/2	23	35	2	13	18	0,01
V510351	3/2	25	38	2	17	22,5	0,02
V520351	3/2	41	55	2	23	30	0,03
V530351	3/2	48	62	2	23	30	0,06
V500551	5/2	34	43	2	13	18	0,01
V510551	5/2	38	50	2	17	22,5	0,02
V520551	5/2	13	74	2	23	30	0,03
V530551	5/2	72	86	2	23	30,5	0,08

## Warning

These products are intended for use in industrial compressed air systems only. Do not use these products where pressures and temperatures can exceed those listed under 'Technical Data'.

Before using these products with fluids other than those specified, for non-industrial applications, life-support systems, or other applications not within published specifications, consult NORGRN.

Through misuse, age, or malfunction, components used in fluid power systems can fail in various modes. The system designer is warned to consider the failure modes of all component parts used in fluid power

systems and to provide adequate safeguards to prevent personal injury or damage to equipment in the event of such failure.

**System designers must provide a warning to end users in the system instructional manual if protection against a failure mode cannot be adequately provided.**

System designers and end users are cautioned to review specific warnings found in instruction sheets packed and shipped with these products.