

Think Automation and beyond...



# LH1D Series Surface Mount Indicators IDEC LED Spider



IDEC CORPORATION

(100506)

# New ø66 Jumbo Dome Ideal for Mounting on

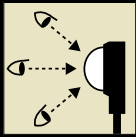

**Excellent Visibility**  
From the front and the side.

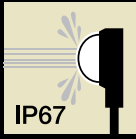

**IP67 Protection**  
Can be used in environments subject to washdown.

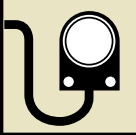

**Cable Wiring**  
Integrated wiring ensures waterproof characteristics.

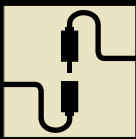

**Connector Wiring** *New*  
Connector types available for easy maintenance.  
\*Jumbo dome type only

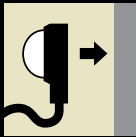

**Direct Surface Mounting**  
Requires only a small space behind the mounting surface, and can be installed without concern for other components behind.

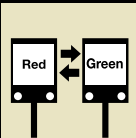

**Red/Green**  
Two-color alternate illumination available.

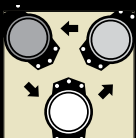

**Three-color Alternate Illumination** *New*  
Two combinations available: red, green and white; and red, green and pure white.  
\*Jumbo dome type only

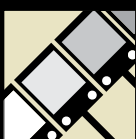

**Seven Colors**  
Amber, green, pure white, red, blue, white, and yellow

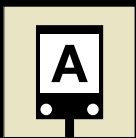

**Legends**  
Marking film can be inserted into the flat type.  
\*Flat type only.

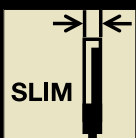

**Slim Profile**  
Can be installed in small areas. Only 10.8 mm in height.  
\*Flat type only.

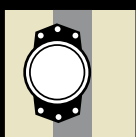

**Direct Mounting on Aluminum Frames** *New*  
Installation is improved by the increased number of mounting holes.  
\*Jumbo dome type only

## ø66 Jumbo Dome Type

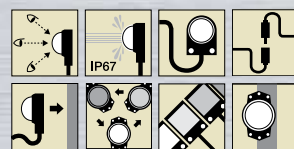

Color Variation			
Amber	Green	Pure White	Red
Blue	White	Yellow	

Two- and three-color alternate illumination also available.

## Application Examples

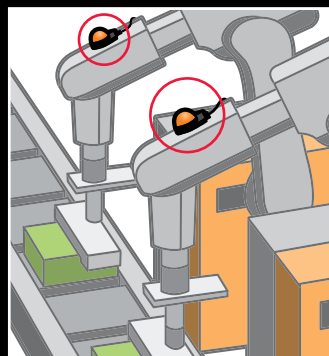

**Robot Arm Status Indicator**

Indicates the operating status of the motor.

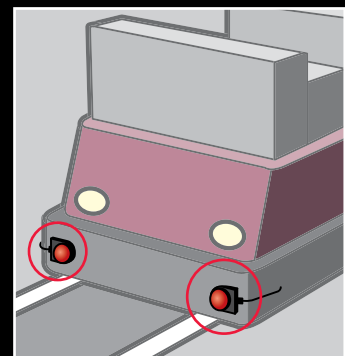

**AGV Status Indicator**

Can be used as a directional indicator on automatic guided vehicles.

# Indicators with Excellent Visibility. Large Equipment.

With increasing awareness on safety at production sites, equipment must be designed to be clearly visible and capable of delivering correct information. With an innovative design, slim and stylish IDEC LED Spiders are ideal for various applications.

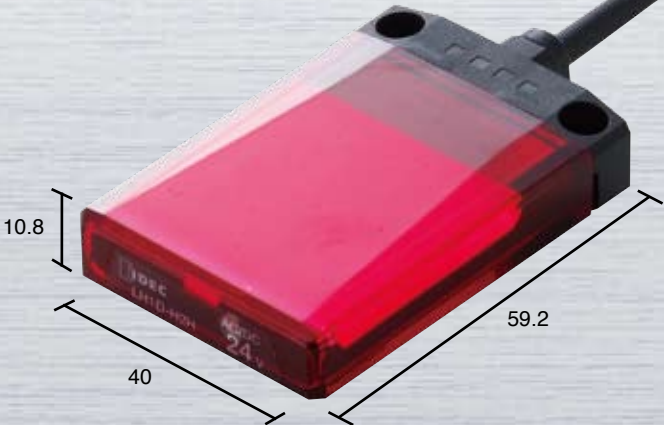

Dimensions in mm.

## Dome Type



## Flat Type

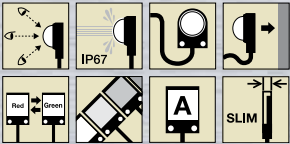

Two-color alternate illumination also available.

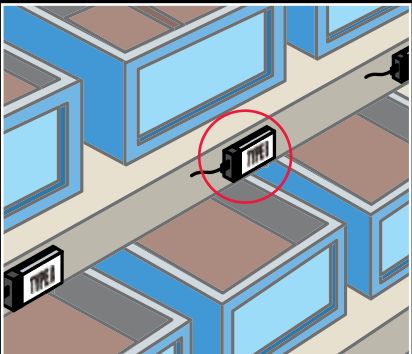

**Picking System**

Can be used to select picking locations.

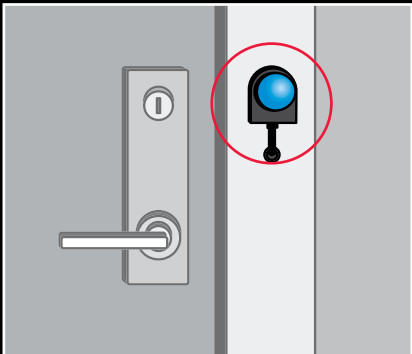

**Door Monitoring**

Indicates whether a door can be opened or closed.

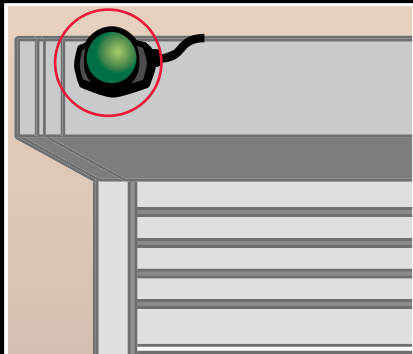

**Roller Shutter Status Indicator**

Indicates the operating status of a roller shutter.

# LH series Surface Mount Indicators

**Innovative indicators with IP67 protection and integrated cable wiring.  
Directly mountable on equipment and aluminum frames (jumbo dome types).**

- Surface mount style does not affect the location of other components. Requires only a small space behind the mounting surface.
- Integrated cable wiring ensures waterproof characteristics. 1m, 3m, and 5m cables available. M12 connector cable (30 cm) available for jumbo dome type.
- IP67 (IEC60529) rated. Can be used in environments subject to washdown.
- Slim design well suited for installation in small spaces.
- Excellent visibility from the front and from the side.
- Legends and symbols can be printed on marking film to customize flat type.
- Two-color alternate illumination available for all types. Three-color alternate illumination available with jumbo dome type.



## Standards

Standards	Marks	File No. or Organization
UL508 CSA C22.2 No.14		UL/c-UL File No. E68961
EN60598-2-1		TÜV SÜD
EN60598-2-1 EN60947-5-1		EC Low Voltage Directive

- LH series surface mount indicators are approved by TÜV as class III lighting fixtures.

## Specifications

Type	Cable	Connector
Rated Insulation Voltage (Ui)	32V	
Rated Voltage	24V AC/DC	24V DC
Operating Voltage Range	24V AC/DC ±10%	24V DC ±10%
Rated Current	17 mA	
Maximum Current Draw	0.6W	

- Use Class 2 power supply when using the LH1D as a UL compliant product.
- Use Class III circuit when using the LH1D as an EN compliant product.
- 24V AC, 50/60 Hz
- M12 connectors are available for jumbo dome types only.

Type	Jumbo Dome	Dome / Flat
Illumination Colors	Single Color	A (amber), G (green), PW (pure white), R (red), S (blue), W (white), Y (yellow)
	Two-Color Alternate	A/G, A/W, A/PW, R/G, R/W, R/PW, G/W, G/PW
	Three-Color Alternate	R/G/W, R/G/PW

## Specifications

Applicable Standards	IEC60947-5-1, IEC60947-1 EN60947-5-1, EN60947-1 EN60598-2-1 UL508, CSA C22.2 No.14
Operating Temperature	-20 to +55°C (no freezing)
Operating Humidity	45 to 85% RH (no condensation)
Storage Temperature	-30 to +80°C (no freezing)
Impulse Withstand Voltage (illuminating part)	800V
Insulation Resistance	Between live and dead parts: 100 MΩ minimum
Dielectric Strength	Between live and dead parts: 2000V, 50/60 Hz, 1 minute
Pollution Degree	3
Vibration Resistance	5 to 55 Hz, amplitude 0.5 mm
Shock Resistance	1000 m/s <sup>2</sup>
Degree of Protection	IP67 (IEC60529) NEMA Type 4X Indoor Use Only (Note)
Housing Color	Black
LED Lamp Life	Approx. 50,000 hours (When used on complete DC at 25°C, brightness reduces to 50% of the initial intensity.)
Weight	140g (jumbo dome type, 1m cable) 50g (dome type, 1m cable) 50g (flat type, 1m cable)



Note: Jumbo dome type is NEMA Type 1 under UL listing.

Type	Jumbo Dome	Dome/Flat
Cable	Single Color	UL20276, 21 AWG, 3-core Cable outside diameter: ø4.9 mm Allowable cable bending radius: 30 mm
	Two-Color Alternate	
	Three-Color Alternate	UL20276, 22AWG, 4-core Cable outside diameter: ø5.0 mm Allowable cable bending radius: 30 mm
Connector	20AWG, 4-core Cable length: 0.3m Cable outside diameter: ø6.0 mm Allowable cable bending radius: 40 mm M12 one-touch connector	

## Jumbo Dome Type

### Types

Package Quantity: 1

Shape	Types	Ordering Type No.	Illumination Color
 Jumbo Dome (ø66) One color	Cable	1m	LH1D-D3HQ4C10①
		3m	LH1D-D3HQ4C30①
		5m	LH1D-D3HQ4C50①
Connector		LH1D-D3HQ4CN1①	
 Jumbo Dome (ø66) 2-color alternate	Cable	1m	LH1D-D3HQ4C10①②
		3m	LH1D-D3HQ4C30①②
		5m	LH1D-D3HQ4C50①②
Connector		LH1D-D3HQ4CN1①②	
 Jumbo Dome (ø66) 3-color alternate	Cable	1m	LH1D-D3HQ4C10①②③
		3m	LH1D-D3HQ4C30①②③
		5m	LH1D-D3HQ4C50①②③
Connector		LH1D-D3HQ4CN1①②③	

- Color code: A (amber), G (green), PW (pure white), R (red), S (blue), W (white), Y (yellow).
- For orange, specify "A" (for amber).

### Dimensions

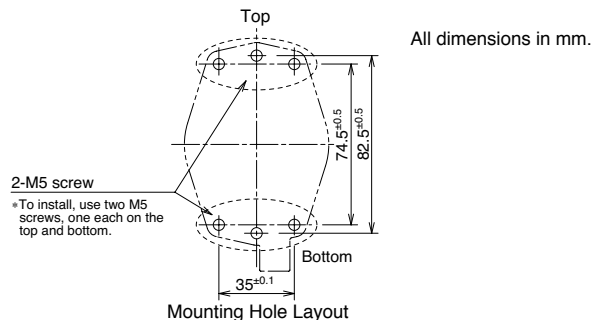
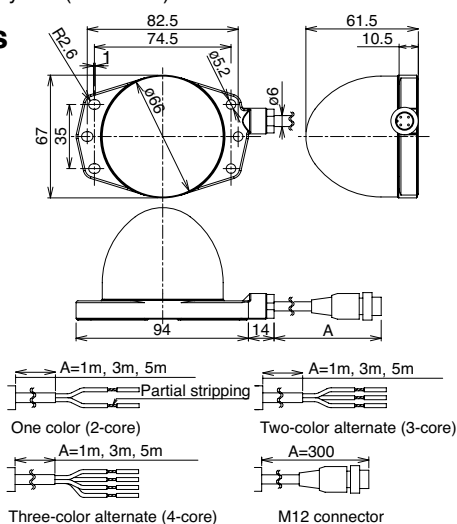

### Lens Colors

	Illumination Color	Lens Color
One Color	Amber (A) Green (G) Pure White (PW) Red (R) Blue (S) White (W) Yellow (Y)	Amber Green White Red Blue White Yellow
Two-color Alternate	Red (R) / Green (G) Green (G) / White (W) Red (R) / White (W) Amber (A) / Green (G) Amber (A) / White (W) Red (R) / Pure White (PW) Green (G) / Pure White (PW) Amber (A) / Pure White (PW)	White White White White White White White
Three-color Alternate	Red (R) / Green (G) / White (W) Red (R) / Green (G) / Pure White (PW)	White White

### Internal Circuit

#### • One-color Illumination

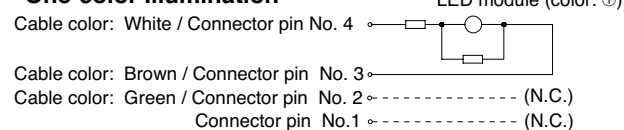

#### • Two-color Alternate Illumination

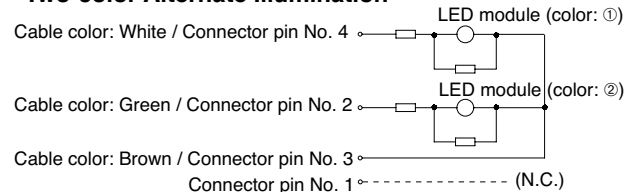

#### • Three-color Alternate Illumination

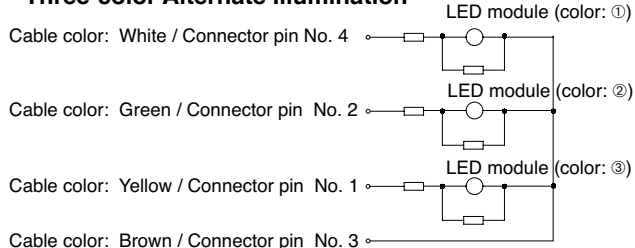

### LED Module Internal Circuit

The schematic of the LED module internal circuit differ depending on the illumination color.

#### • Illumination color: A, R, W • Illumination color: G, PW, S

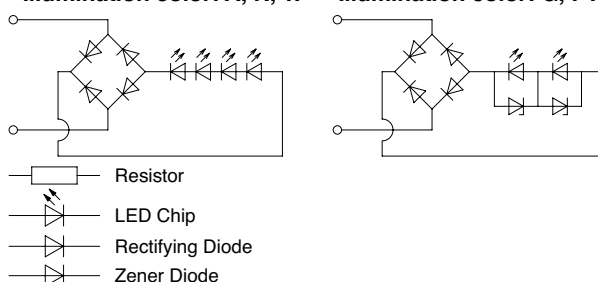



Note: For the schematic of the LED module, see "LED Module Internal Circuit" on the right.

# LH Series Surface Mount Indicators

## Dome Type

### Types

Package Quantity: 1

Shape	Cable	Ordering Type No.	Illumination Color
Dome ø37 One Color 	1m	LH1D-D2HQ4C10①	Specify a color code in place of ① in the Type No. A: amber G: green PW: pure white R: red S: blue W: white Y: yellow
	3m	LH1D-D2HQ4C30①	
	5m	LH1D-D2HQ4C50①	
Dome ø37 Red/Green 2-color alternate 	1m	LH1D-D2HQ4C10RG	R (red) / G (green) 2-color alternate illumination
	3m	LH1D-D2HQ4C30RG	
	5m	LH1D-D2HQ4C50RG	

•For orange, specify "A" (for amber).

### Dimensions

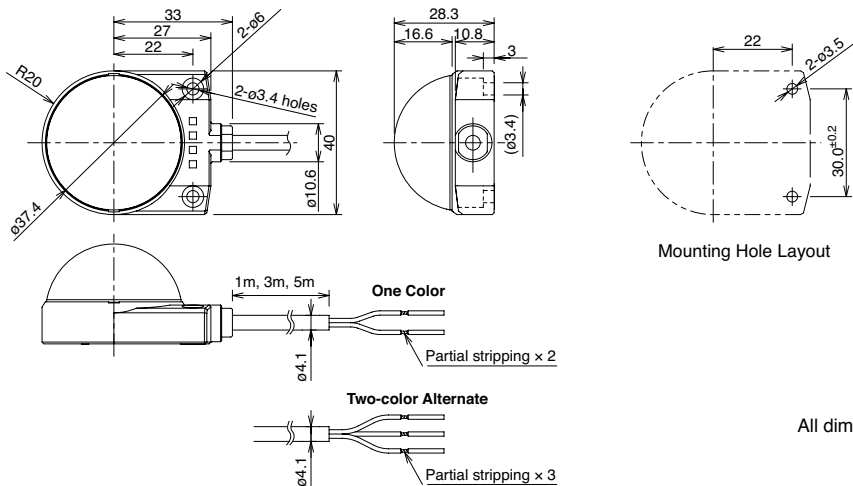

### Internal Circuit

#### • One-color Illumination

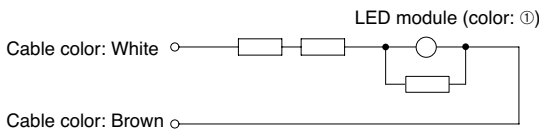

#### • Two-color Alternate Illumination

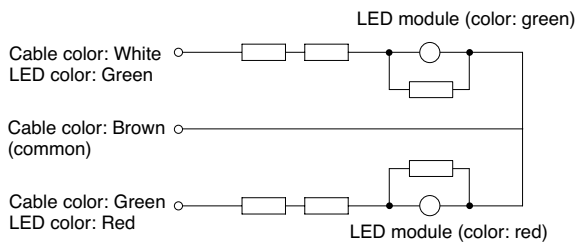

### Lens Colors

Illumination Type	Illumination Color	Lens Color
One Color	Amber (A)	Amber
	Green (G)	Green
	Pure White (PW)	Clear (Note)
	Red (R)	Red
	Blue (S)	Blue
	White (W)	Clear (Note)
	Yellow (Y)	Yellow
Two-color Alternate	Red (R) / Green (G)	Clear (Note)

Note: Because lenses have a white diffusion cover inside, pure white, white, and red/green types appear white when the light is off.

### LED Module Internal Circuit

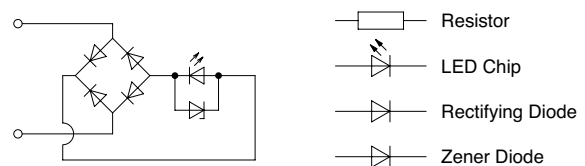



Note: For the schematic of the LED module, see "LED Module Internal Circuit" on the right.

## Flat Type

### Types

Package Quantity: 1

Shape	Cable	Ordering Type No.	Illumination Color
Flat One Color 	1m	<b>LH1D-H2HQ4C10</b> ⓪	Specify a color code in place of ⓪ in the Type No. A: amber G: green PW: pure white R: red S: blue W: white Y: yellow
	3m	<b>LH1D-H2HQ4C30</b> ⓪	
	5m	<b>LH1D-H2HQ4C50</b> ⓪	
Flat Red/Green 2-color Alternate 	1m	<b>LH1D-H2HQ4C10RG</b>	R (red) / G (green) 2-color alternate illumination
	3m	<b>LH1D-H2HQ4C30RG</b>	
	5m	<b>LH1D-H2HQ4C50RG</b>	

• For orange, specify "A" (for amber).

### Dimensions

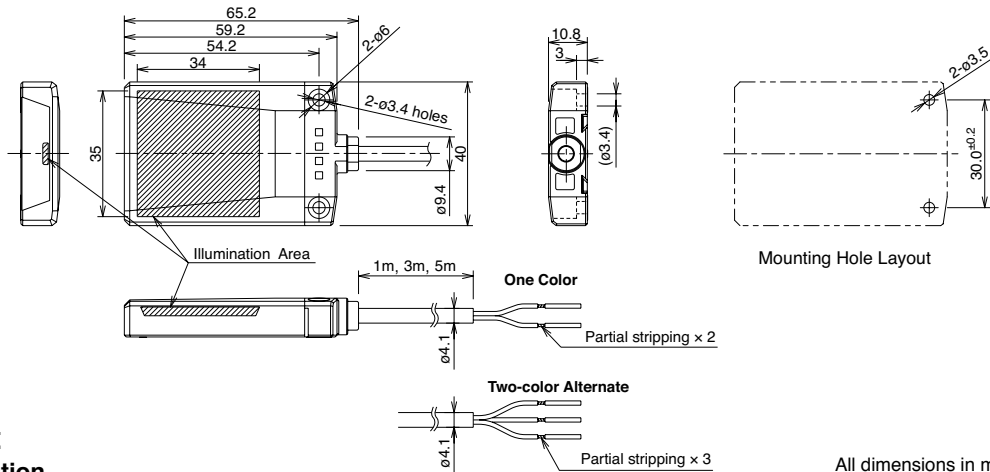

All dimensions in mm.

### Internal Circuit

#### • One-color Illumination

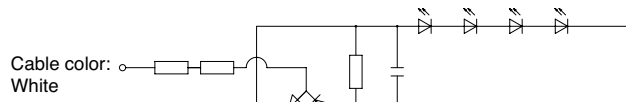

Cable color: Brown

#### • Two-color Alternate Illumination

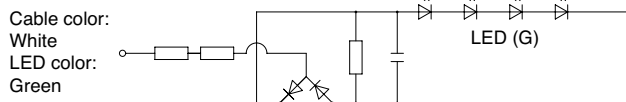

Cable color: Brown (common)

Cable color: Green  
LED color: Red

### Lens Colors

Illumination Type	Illumination Color	Lens Color
One Color	Amber (A)	Amber
	Green (G)	Green
	Pure White (PW)	Clear
	Red (R)	Red
	Blue (S)	Blue
	White (W)	Clear
	Yellow (Y)	Yellow
Two-color Alternate	Red/Green	Clear

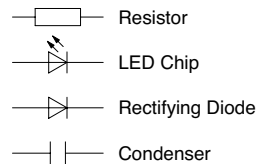

### Replacement Parts

Shape	Material	Ordering Type No.	Lens Color
Lens (flat type) 	Polyarylate	<b>LH9Z-1DLH2</b> ⓪	For flat type. Specify a color code in place of ⓪ in the Type No. A: amber C: clear G: green R: red S: blue Y: yellow Note: Use C (clear) lens for R / G (red/green alternate), W (white), or PW (pure white) illumination.

# LH Series Surface Mount Indicators

## Safety Precautions

- Do not disassemble, repair, or modify the LH1D indicator, otherwise electric shock, damage, fire, or malfunction may occur.
- Do not pull out or push in the cable of the LH1D indicator, otherwise damage may occur. Provide a slack in the cable while wiring.
- The LH1D indicator is a general-purpose and industrial electronic device. Do not use the LH1D indicator for electronic equipment which may damage the human body or threaten life in case of malfunction or failure.

## Operating Instructions

- LED elements may vary in colors and brightness.
- The LH1D indicator is vulnerable to static electricity. Take sufficient protection against static electricity and spikes.
- For one-color illumination of cable types, the green wire is cut short because it is not used. When cutting the cable for shorter wiring, cut the green wire short or make sure that the green wire is not used.
- The pin layout of connector type is shown at the right.

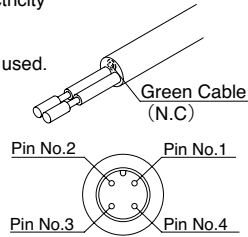

- Excessive shock to the LH1D may cause damage or failure, and the internal lens may fall off even if no detects are found externally. The internal lens may have fallen off when:
  - The illumination varies greatly when viewed from the side.
  - The indicator makes a rattling sound when shaken lightly.
 When any of the above is observed, contact IDEC.

Note: Do not remove the lens.  
The specified degree of protection cannot be assured when the lens is removed.

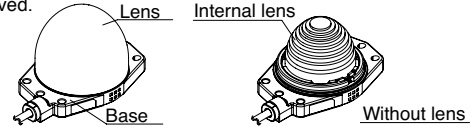

## Panel Mounting

Using two M3 screws (M5 screws for jumbo dome types), install the LH1D indicator to a mounting surface. Tighten the screws to a torque of 0.6 N·m maximum (1.0 to 1.4 N·m for jumbo dome types). Mounting screws are not provided and must be supplied by the user.

### Jumbo Dome Type

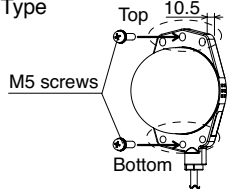

Note 1: Take into account the thickness of the base (10.5 mm), when selecting the length of the screws.

Note 2: Take appropriate anti-loosening measures such as spring washers and screw locks.

Note 3: Install the LH1D using two M5 screws, one each on the top and the bottom.

### Dome Type

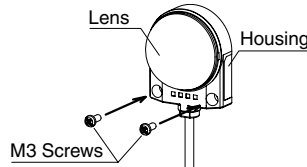

Note: The dome lens is not removable. Do not attempt to remove the lens, otherwise damage will occur.

### Flat Type

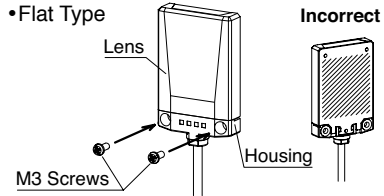

Note 1: Do not install the LH1D indicator by attaching only the lens, such as by taping down the lens. Otherwise internal components may come loose.

Note 2: Make sure that the back of the indicator is securely attached to the mounting surface, so that the lens cannot be easily removed.

## Inserting Marking Film into Flat Type Lens

- Insert a flat screwdriver into the groove between the base and lens. Do not use flat screwdrivers with a tip width of 1.0 mm or more.

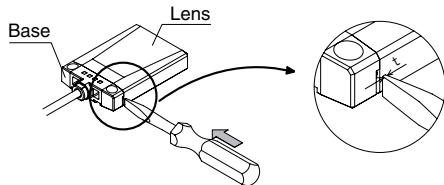

- Twist the screwdriver and disengage the lens from the base.

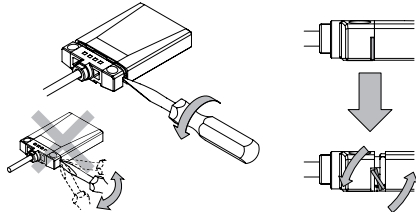

- Remove the lens from the base.

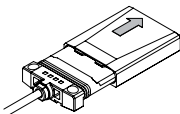

- Insert the edge of a marking film into the gap between the base and the diffusion plate, and place the marking film on top of the diffusion plate.

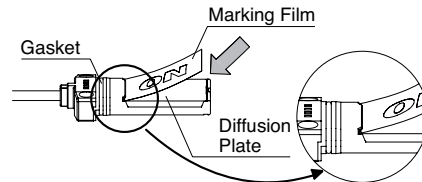

- Install the lens. Ensure that the lens is installed snugly.

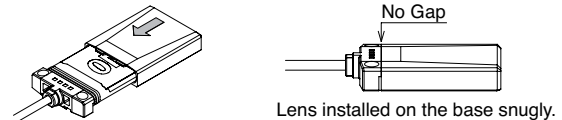

Note 1: Do not touch the gasket, as this may affect its waterproof characteristics.  
Note 2: Do not touch the diffusion plate.

## Markings

Legends and symbols can be printed on marking film for the flat lens. One 0.1mm-thick film can be installed. Marking film is not attached and must be supplied by the user. Recommended marking film: Polyester

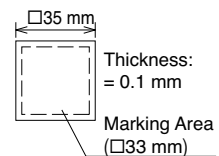

Specifications and other descriptions in this catalog are subject to change without notice.



## IDEC CORPORATION

IDEC CORPORATION (USA)  
Tel: +1-408-747-0550 / (800) 262-1DEEC (4332)  
E-mail: opencontact@idec.com

IDEC CANADA LIMITED  
Tel: +1-905-890-8561, Toll Free: (888) 317-4332  
E-mail: sales@ca.idec.com

IDEC AUSTRALIA PTY. LTD.  
Tel: +61-3-9763-3244, Toll Free: 1800-68-4332  
E-mail: sales@au.idec.com

IDEC ELECTRONICS LIMITED  
Tel: +44-1256-321000 E-mail: sales@uk.idec.com

IDEC ELEKTROTECHNIK GmbH  
Tel: +49-40-25 30 54 - 0 E-mail: service@idec.de

IDEC (SHANGHAI) CORPORATION  
Tel: +86-21-5353-1000 E-mail: idec@cn.idec.com

IDEC (BEIJING) CORPORATION  
Tel: +86-10-6581-6131

IDEC (SHENZHEN) CORPORATION  
Tel: +86-755-8356-2977

IDEC IZUMI (H.K.) CO., LTD.  
Tel: +852-2803-8989 E-mail: info@hk.idec.com

IDEC TAIWAN CORPORATION  
Tel: +886-2-2698-3929 E-mail: service@tw.idec.com

IDEC IZUMI ASIA PTE. LTD.  
Tel: +65-6746-1155 E-mail: info@sg.idec.com