

Contact insert - HC-K 6/12-ESTS - 1636350

Please be informed that the data shown in this PDF Document is generated from our Online Catalog. Please find the complete data in the user's documentation. Our General Terms of Use for Downloads are valid (<http://download.phoenixcontact.com>)



HEAVYCON male insert, K6/12 series, with 6 power (axial screw connection) and 12 control contacts (screw connection)

Key commercial data

package_quantity	1
GTIN	4046356011495

Technical data

General

Note	For HEAVYCON ADVANCE and HEAVYCON housing of type B16/B32, axial connection for 2 mm Allen wrench
Connection method	Axial screw connection (power contacts)
Connection method	Signal Screw connection
Tightening torque	1.5 Nm (Power contacts 2.5 - 4 mm ²)
Tightening torque	0.8 Nm (control contacts)
Tightening torque	2 Nm (Power contacts 6 -8 mm ²)
Pollution degree	3
Surge voltage category	III
Number of positions	6+12+PE
No. of power contacts	6
No. of control contacts	12
Insertion/withdrawal cycles	≥ 500
Design	B16
Conductor cross section	2.5 mm ² ... 8 mm ²
Conductor cross section	0.2 mm ² ... 2.5 mm ²
Connection cross section AWG	12 ... 10
Connection cross section AWG	24 ... 14 (control contacts)
Stripping length of the individual wire	8 mm +1 (Power contacts, 2.5 - 8 mm ²)
Stripping length of the individual wire	10 mm (control contacts)
Wire diameter including insulation	6.2 mm (Max., power contacts)
Assembly instructions	-The axial screw connection must be established using a 2 mm Allen wrench.-Use only stranded wires for axial screw connection.- Plug-in connections may only be operated only when there is no load/voltage.

Contact insert - HC-K 6/12-ESTS - 1636350

Technical data

General

Connection	<p>Note regarding axial connection technology: Only for stranded wires. The conductor cross sections stated refer to the geometric cross section of the cable used. Use of cables with a geometric cross section very different from that of the cable's nominal cross section should be checked before use. The wiring space of the axial screw method is designed for fine strand cables according to VDE 0295 class 5. Deviating cable structures (e.g. class 6 cables) should be checked before use. Connection Before starting to connect, ensure that the tapered screw is turned back all the way (chamber is open). The cables must not be twisted. The cores should be slid to the limit stop in the contact chamber (until insulation touches contact). Hold cores in position and use socket wrench to tighten. The used core end should be cut off before connecting again. The connection screw may only be retightened once to prevent the strands from breaking. To prevent damage to the contact, the core / cable should be mechanically intercepted at an appropriate distance from the connection point (e.g. by using a plate cutout). DIN VDE 0100-520:2003-06 contains information on how to do this correctly.</p>
-------------------	---

Ambient conditions

Ambient temperature (operation)	-40 °C ... 125 °C
--	-------------------

Material data

Inflammability class according to UL 94	V0
Contact material	Cu alloy
Material of contact surface, power contact	Ag
Material of contact surface, control contact	Ag
Contact carrier material	PC

Electrical characteristics

Rated voltage for power contacts	230/400 V
Rated voltage (III/3)	Power 690 V
Rated voltage (III/3)	Signal 230 V (Conductor-PE)
Rated voltage (III/3)	Signal 400 V (Conductor-Conductor)
Rated surge voltage	8 kV (power contacts)
Rated surge voltage	4 kV (control contacts)
Rated current	40 A (power contacts)
Rated current	10 A (control contacts)

classifications

eCl@ss

eCl@ss 4.0	27140816
eCl@ss 4.1	27140816
eCl@ss 5.0	27143424
eCl@ss 5.1	27143424
eCl@ss 6.0	27143424
eCl@ss 7.0	27440209

Contact insert - HC-K 6/12-ESTS - 1636350

classifications

eCl@ss

eCl@ss 8.0	27440209
------------	----------

ETIM

ETIM 2.0	EC000438
ETIM 3.0	EC000438
ETIM 4.0	EC000438
ETIM 5.0	EC000438

UNSPSC

UNSPSC 6.01	30211923
UNSPSC 7.0901	39121522
UNSPSC 11	39121522
UNSPSC 12.01	39121522
UNSPSC 13.2	39121522

approvals

CSA / UL Recognized / GOST /

Approval details

	
Nominal voltage UN	600 V
Nominal current IN	40 A
mm ² /AWG/kcmil	13-7

	
Nominal voltage UN	600 V
Nominal current IN	
mm ² /AWG/kcmil	

	
---	--

Drawings

Contact insert - HC-K 6/12-ESTS - 1636350

Diagram

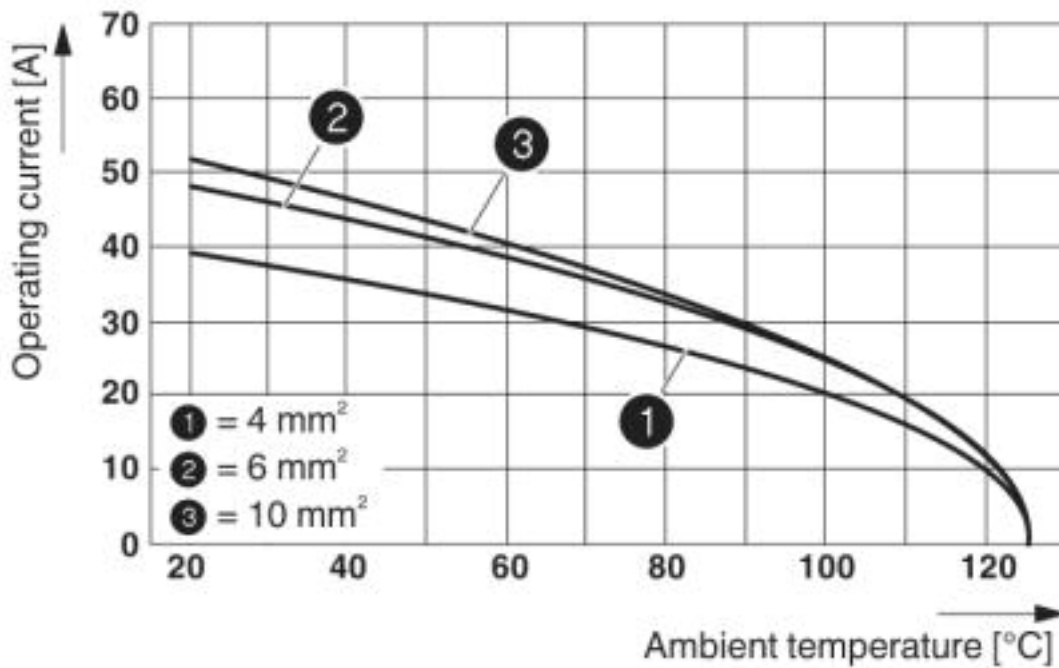

Derating curve

Dimensioned drawing

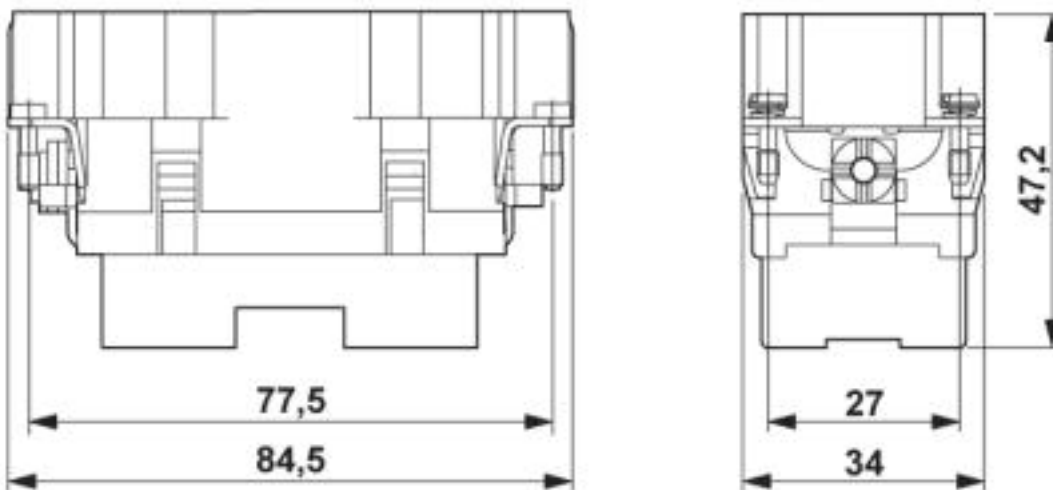

Dimensional drawing

Contact insert - HC-K 6/12-ESTS - 1636350

Dimensioned drawing

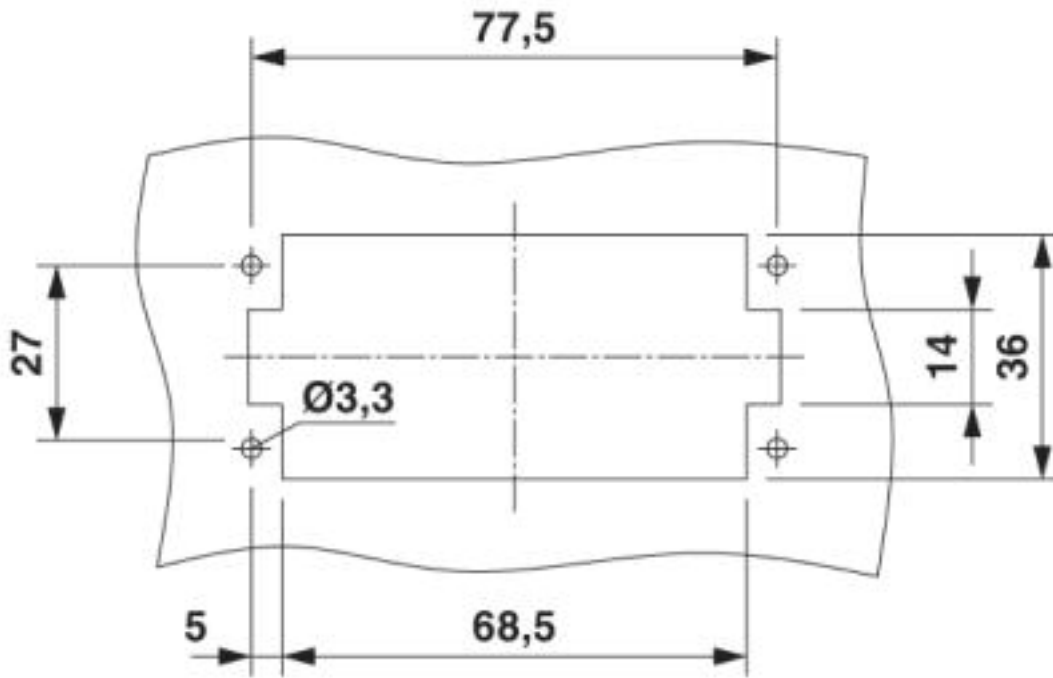

Panel cutout

Contact insert - HC-K 6/12-ESTS - 1636350

Schematic diagram

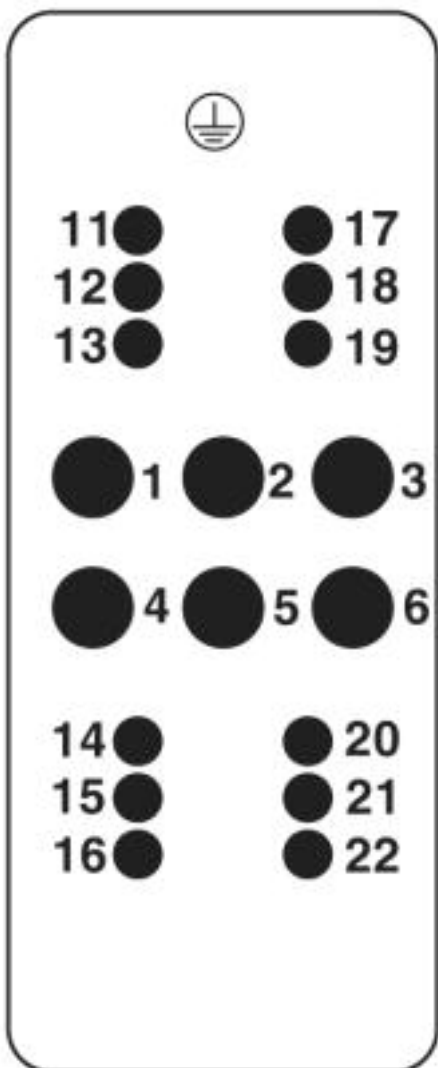

Connector pin assignment, connection side

Schematic diagram

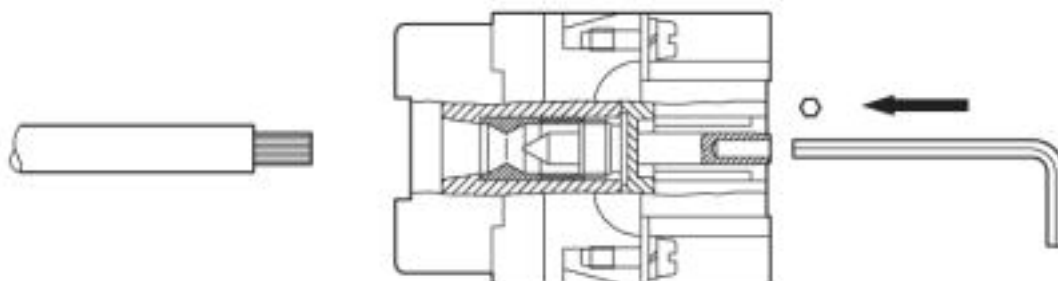

Axial connection

